

# Main document

## User Manual

### English

#### General part

#### MP-Monitor

Air module



Fire & Smoke module



VAV-Compact module



VAV-Compact D3-module



Water globe module



Water globe module NG



ePIV module



VAV NMV-D2M module



VAV VRP-M module

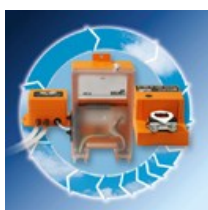

MPL module



CM VAV module



VRU module



PR(K) module



PM/PK module



# **PC-Tool V3.16**

## **User Manual**

### **English**

#### **General Part**

## Table of Contents

1	Basics.....	4
1.1	Introduction .....	4
1.2	Information on using the manual .....	4
1.3	General structure of the user interface .....	5
1.4	Modules and actuator types.....	6
2	Getting started with PC-Tool.....	7
2.1	Connecting the computer with the actuators .....	7
2.2	Starting the program.....	7
2.3	Adapting PC-Tool options.....	7
2.4	Creating a new project.....	8
2.5	Setting up the program .....	8
2.6	Displaying actuator parameters .....	9
2.7	Further actions .....	9
3	Basic functions .....	10
3.1	Program start .....	10
3.2	Projects .....	11
3.2.1	Project data .....	11
3.2.2	Creating a new project.....	11
3.2.3	Opening a project .....	11
3.2.4	Changing project data.....	11
3.2.5	Exporting a project.....	12
3.2.6	Copying a project.....	12
3.2.7	Deleting a project.....	12
3.3	MP-Channel .....	12
3.3.1	Serial interface.....	12
3.3.2	Bus scan.....	13
3.4	Setting the bus address.....	14
3.4.1	Series addressing of actuators .....	15
3.4.2	Addressing with known serial numbers .....	17
3.4.3	Resetting actuator addresses .....	17
3.4.4	Addressing a single actuator.....	19
3.5	Selecting a module.....	20
3.6	Actuator parameters.....	21
3.6.1	Displaying actuator parameters .....	21
3.6.2	Printing out actuator parameters.....	21
3.6.3	Deleting maintenance/error messages.....	21
3.7	Configuring an actuator .....	23
3.7.1	Saving a parameter file.....	25
3.7.2	Loading a parameter file .....	25
3.7.3	Copying parameters .....	25
3.7.4	Load factory settings.....	25

3.8	Parameterizing limited lots .....	27
3.10	Printing labels.....	30
3.10.1	Setting up a configuration file.....	30
3.10.2	Printing labels.....	30
3.10.3	Printing labels offline.....	31
3.10	Transformation tables.....	31
3.11	Displaying recorded trend data.....	34
3.12	PC-Tool options.....	36
3.13	Log file	37
4	Attachment .....	39
4.1	Storage locations of files .....	39
4.1.1	Project data .....	39
4.1.2	Configuration files.....	39
4.2	Configuration files for printing labels.....	40
4.2.1	Storage location.....	40
4.2.2	Format .....	40
4.2.3	Boxes .....	41
4.2.4	Example of a label .....	43
4.3	Troubleshooting and error messages .....	45
4.3.1	General.....	45
4.3.2	Error messages .....	45
4.3.3	ISO 8859-1/ANSI character set .....	50
4.4	Typical wiring diagrams .....	51
4.4.1	Overview table.....	51
4.4.2	Typical wiring diagrams .....	52

# 1 Basics

## 1.1 Introduction

The user manual describes the functions of the Belimo PC- Tool. The Belimo PC-Tool is a PC-based tool for parameterizing Belimo MFT(2), MP, MF, LON and BF-TopLine actuators, MFT(2), MP and BF-TopLine actuators can be configured for MP-Bus operation and can be monitored via bus.

This document is designed to present basic information. Since the PC-Tool has a modular structure, the explanations for specific modules are given in the individual module documents.

Remark: The documentation of the individual modules can be accessed through the main document.

## 1.2 Information on using the manual

An arrow symbol shows the order of menu commands in sub-menus. For the function

MP-Channel ► Trigger scan,  
select MP-Channel in the main menu and then Trigger scan in the submenu.

This manual uses English terms for control elements frequently encountered in Microsoft Windows:

Button  
Combobox  
Radio button  
Checkbox

---

Notes are enclosed in separation lines.

---

Variant If a function can be triggered in several ways, variant ways are described in addition to the recommended way.

### 1.3 General structure of the user interface

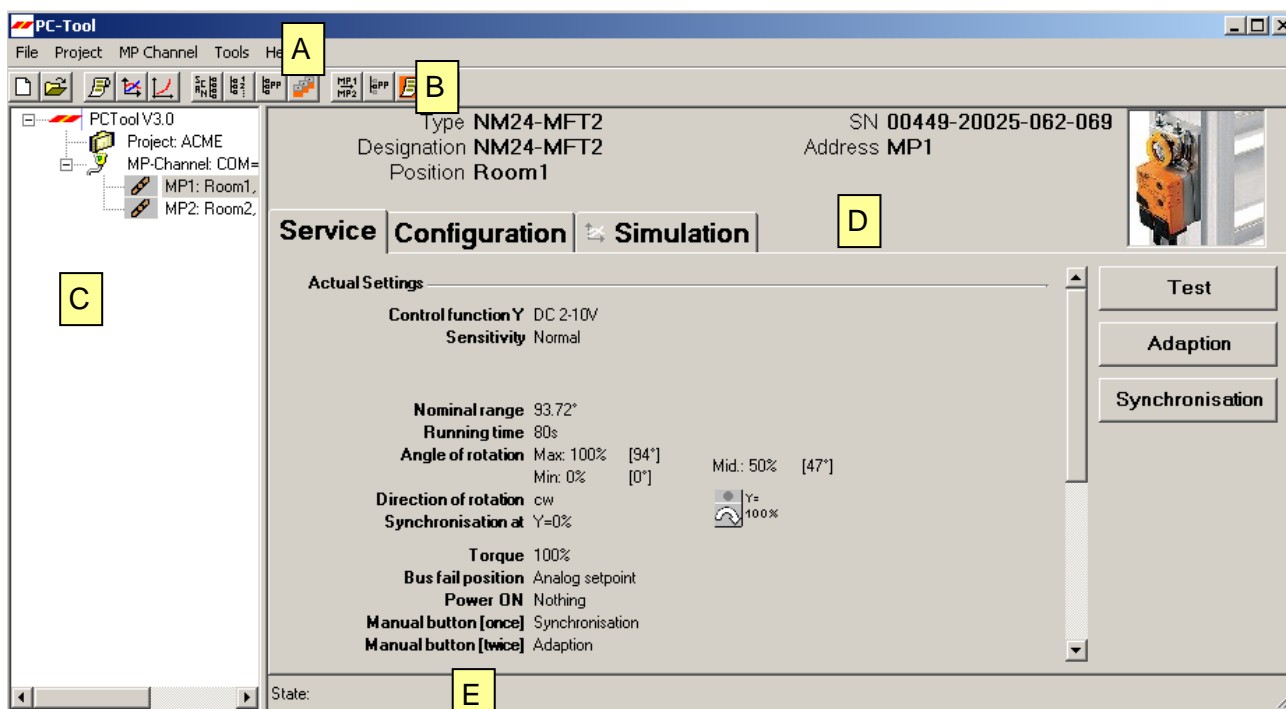

User interface PC-Tool



Menu bar [A] and toolbar [B] provide functions that affect the program as a whole. An explanatory text (tooltip) appears for each icon in the toolbar when you position the mouse pointer on it.

The MP-Channels and actuators belonging to the project are displayed in the outline bar [C] in the form of a tree (as in the Explorer). The object to be worked on is marked here. Depending on the selected object, pop-up menus offer corresponding functions at a click of the right mouse button.

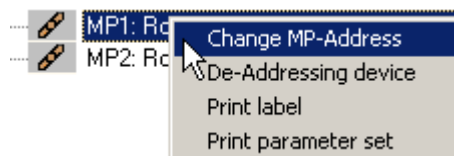

Pop-up menu after clicking the right mouse button

The detail area [D] contains all the detailed information on the object marked. The values that are displayed and changed in this area are grouped as needed and distributed over several index tabs.

The status bar [E] at the lower margin shows the current status of the connected device (e.g.: the actuator is carrying out a synchronization or adaptation.)

Missing or invalid entries are indicated by a flashing exclamation mark. If you move the mouse pointer to the exclamation mark, an explanatory text (tooltip) appears.



Inactive commands are displayed in gray letters (or as gray icons) according to the Windows standard.

Texts in boxes with a black font on a gray background cannot be changed. You can mark the contents with the mouse, however, and copy them into the clipboard with CTRL+C, for example.

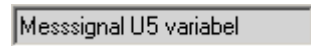

## 1.4 Modules and actuator types

### Multifunctional damper actuators

The following actuator types can be parameterized with the program PC-Tool:

Generation	Type	MP-bus	Sensors
NEW	MP	YES	active, passive, switch
	MPL	YES	(see datasheet)
	MF	No	(none)
OLD	MFT2	YES	active, passive, switch
	MFT	YES	active, switch
	BF..24TL..	YES	(none)

The manual is organized according to the application areas for actuators (modules). Detailed descriptions can be found in the module-specific sections, e.g. Air module, Water module, Fire & Smoke module, VAV module, EPIV Module.

### VAV controller

The VAV module (VAV = Variable Air Volume) is for operating and parameterizing the Belimo VAV-Compact controller xMV-D2-MP.

## 2 Getting started with PC-Tool

### 2.1 Connecting the computer with the actuators

Connect the level converter ZIP-USB-MP to your computer. The connection of the actuators to the ZIP box is explained in the Appendix. If you use a different interface than COM1, you must subsequently adapt the setting [⇒ 3.3.1 Serial interface].

For typical wiring diagrams, see ⇒ 4.4 Typical wiring diagrams

### 2.2 Starting the program



Click the program icon on your desktop. A start screen appears. Click Start Belimo PC-Tool (bottom right).

### 2.3 Adapting PC-Tool options

When you start the program for the first time, a dialog is displayed for adapting the user-specific settings.

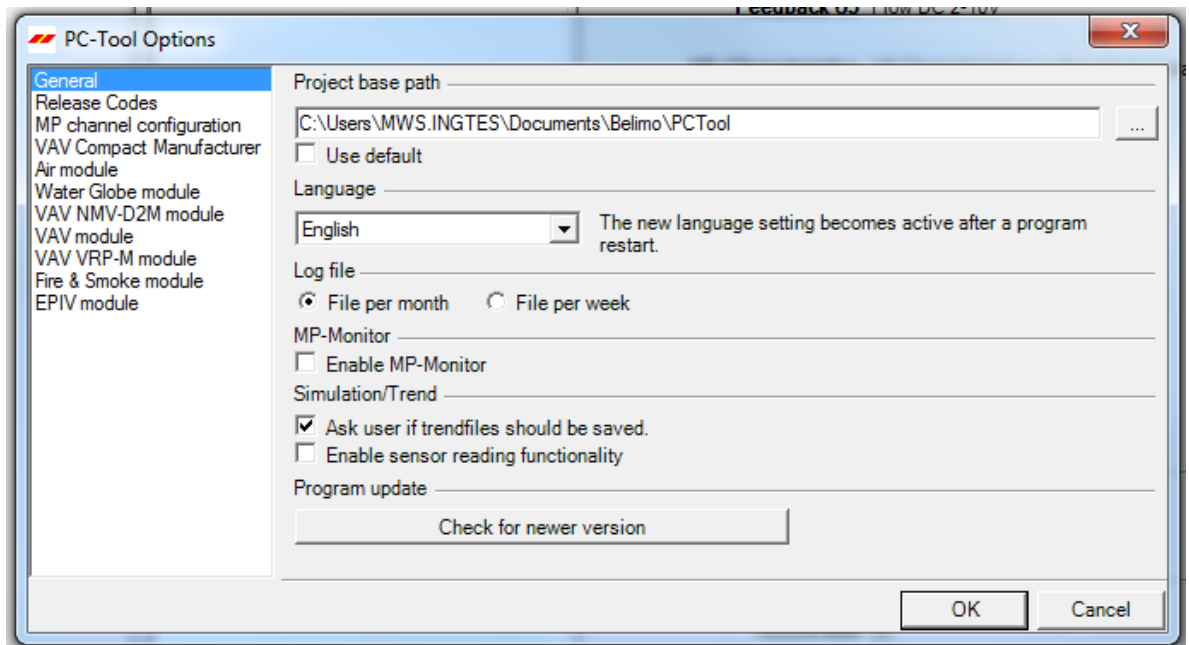

*PC-Tool options*

Select the desired language in the combobox here. If you change the language, exit the program and restart it.



## 2.4 Creating a new project

To work with the program, you have to create a "project". The dialog for entering the project data is displayed. Click the radio button "New project".

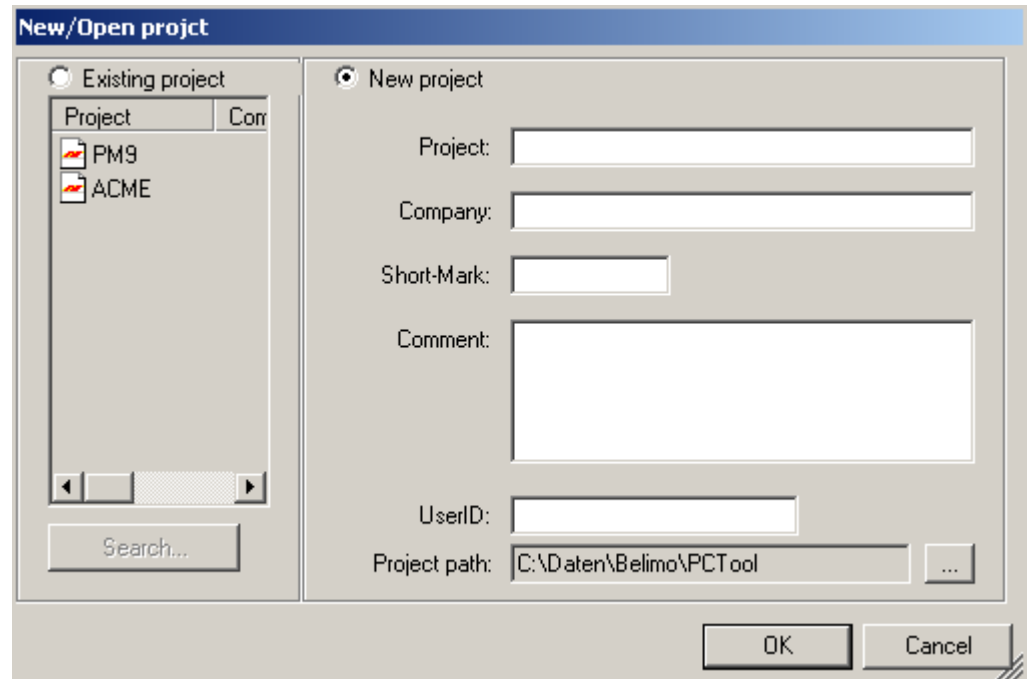

*Creating a new project*

The project name, company and user ID must be filled in; all other information is optional.

## 2.5 Setting up the program

The project and the MP-Channel can be seen in the outline bar [C]. The bus is scanned every 10 seconds by default.

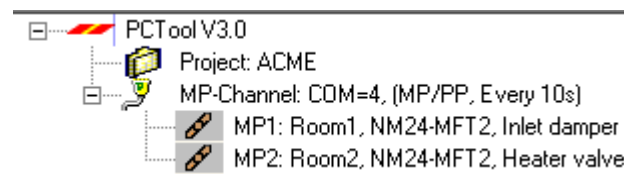

*Outline bar [C]*

---

If no actuators are shown after 10 seconds, you should check whether the level converter ZIP-USB-MP is connected to the right COM interface. Adjust the settings for the serial interface if necessary [⇒ 3.3.1].

---

## 2.6 Displaying actuator parameters

Select the desired actuator in the outline bar [C] by clicking it with the mouse.  
The current settings for the actuator are displayed in the detail area [D].

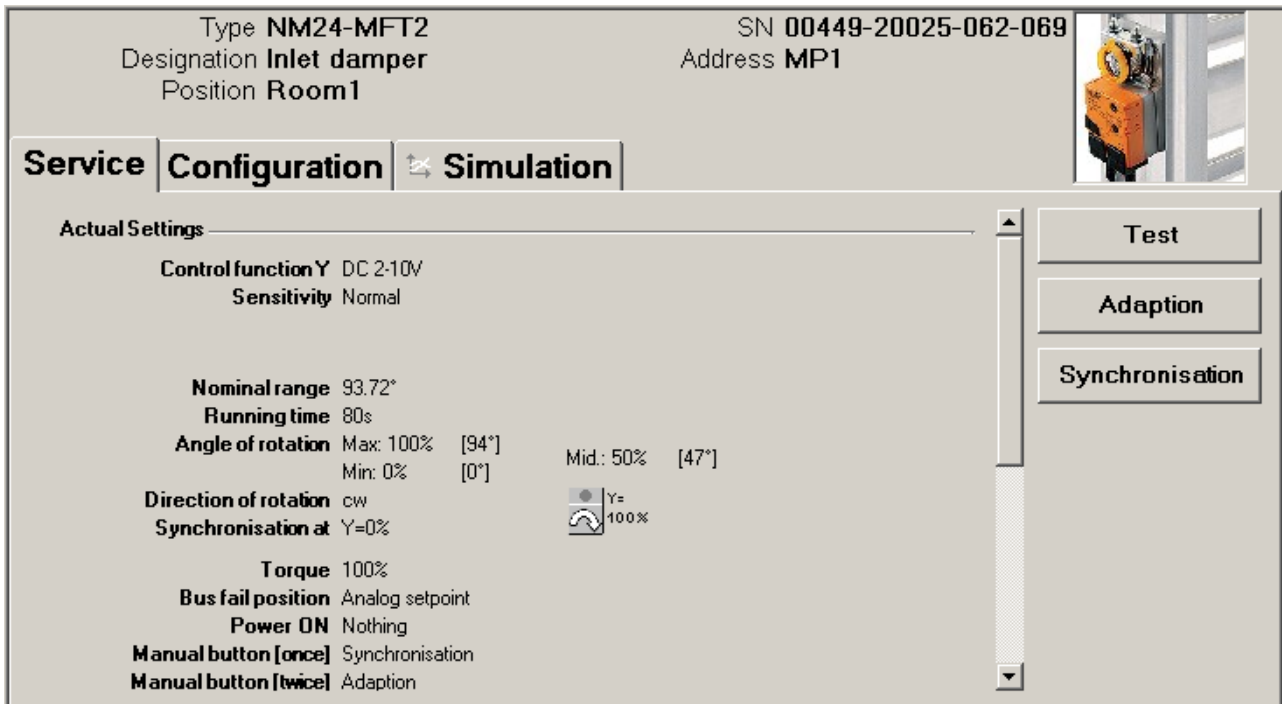

Example of detail area [D] (damper actuator)

## 2.7 Further actions

Read the descriptions for the following topics in Section 3 Basic functions

- Bus scan
- Setting the bus address
- Parameterization of actuators

Read the details for the application areas of the actuators in the descriptions of the following modules

- Damper actuators (Air module)
- VAV controllers
- Actuators for fire & smoke dampers (Fire & Smoke module)
- Valve actuators (Water module)

## 3 Basic functions

### 3.1 Program start

After the program is started, a start screen is displayed. Click Start.

Determine the project with which you would like to work. You can either

- open one of the last projects listed,
- open an existing project from a file, or
- create a new project.

The defined MP-Channel is displayed and opened. A bus scan is started for each MP-Channel.

---

If only one actuator is connected, it is automatically selected and displayed.

---

Variant If you cancel the project selection, the program will be started without a project. In this case, only the functions Help, File▶ New project and File ▶ Open existing project will be available.

You can also start the program by means of opening a project file: In the Explorer, double-click a file with the extension . btpj or on a corresponding file link.



---

If you create a link to a project file on the desktop, make sure that you do not inadvertently move or copy the file instead. You can tell when a link has been created correctly by the small arrow in the bottom left-hand corner of the file icon. (If the project file itself, rather than a link to it, is on the desktop then all other files will be saved there as well.)

---

In a network environment, the program should be installed on your workstation and started locally. Special authorizations are required to start the program on network drives.

---

## 3.2 Projects

### 3.2.1 Project data

All user-specific data of the program are administered in the framework of projects. Each project has a project directory in the file system. The project files are stored in sub-directories of the project directory.

---

The storage place of the project files is described in the Appendix.

---

### 3.2.2 Creating a new project

Select File ►, New Project in the main menu. Enter the new project data in the dialog. The project name, company and user ID must be filled in; all other information is optional. Click OK.

Since only one project can be active at a time, the currently displayed project will be closed and the new project opened.

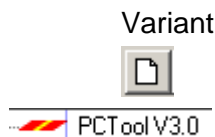

You can also create a new project by clicking the New Project icon on the toolbar [B] or clicking the program icon in the outline bar [C] with the right mouse button and then selecting New Project.

### 3.2.3 Opening a project

Select File ► Open Existing Project in the main menu. A list of all project files in the storage location is displayed.

Mark a project from the list in the dialog or open any given project file (\*. bptp.j) with Find.... Click OK.

Since only one project can be active at a time, the currently displayed project will be closed and the selected project opened instead.

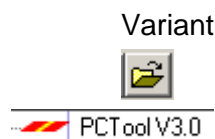

You can also create a project by clicking on the New Project icon on the toolbar [B] or clicking the program icon in the outline bar [C] with the right mouse button and then selecting Open Project.

### 3.2.4 Changing project data

Click the project in the outline bar [C] to display the project data. The Edit button (far right) displays a dialog in which you can change the data.

Variant Click the project in the outline bar [C] with the right mouse button and select Properties.

Project name and path cannot be changed within the program. However, you can rename the project file (extension . bptp.j) using the Windows Explorer or move the entire project folder to another location. Afterwards, open the project again.

---

The project folder and project file can have different names – for example for backing up data. The name of the project file determines the project name.

---

### 3.2.5 Exporting a project

Copy the entire project folder in the Explorer, for example onto a floppy disk.

### 3.2.6 Copying a project

Copy the entire project folder to another location in the Explorer. Give the project folder a new name. Give the project file (<project>.btpj) the same name within the new project folder.

### 3.2.7 Deleting a project

Delete the entire project folder in the Explorer. The project to be deleted must not be currently open in the program.

## 3.3 MP-Channel

### 3.3.1 Serial interface



MP-Strang:

The ZIP level converter is connected to a serial interface (COM) for connecting the MP/MFT(2) actuator or the MP-Bus to the PC-Tool. On the first connection of the ZIP level converter the Application installs automatically the necessary drivers. To select the number of the serial interface used on your computer, click the MP-Channel icon in the outline bar [C] and select MP-Channel settings.

For typical wiring diagrams, see ⇒ 4.4 Typical wiring diagrams

Now set the serial connection:

- If you activate the "Serial connection" box (as shown in the screenshot), you can select a serial connection. This list shows all ports on your computer (between COM=1 ... COM=255).
- Option: If you activate the "Other" box, you can enter a connection ID in the text box. Valid values are:
  - "COMx" or "COM:x" or "COM=x" (x is is the port number between 1 and 255).
  - "Baudrate=x" (x is the baud rate 75...115200).
  - "Bytesize=x" (x is the number of data bits 5...8).
  - "Stopbits=x" (x is the number of stopbits 1, 1.5 or 2).
  - "Parity=x" (x is the the parity no, odd, even, mark or space).

It is only mandatory for the COM port to be specified. Separate the values with a semicolon (;).

Example:

"COM1;Baudrate=9600;Stopbits=1".

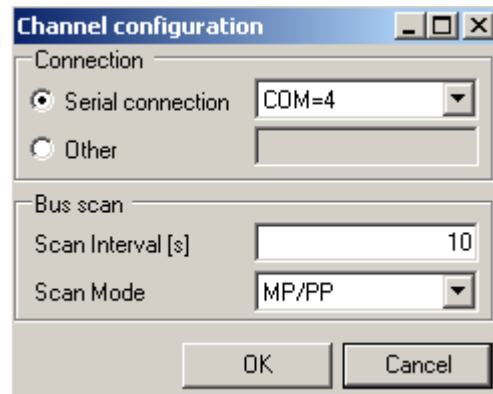

*MP-Channel settings*

### 3.3.2 Bus scan

In the bus scan section of the "MP-Channel settings" dialog, you can enter the time interval for the periodic bus scan in seconds. Permitted values are whole numbers between 1 and 9999.

The program can address actuators in two basic ways:

In multi-point mode (MP), up to 8 actuators of the types MP / MFT(2) can be individually digitally addressed.

In point-to-point mode (PP) only a single actuator can be activated. In this case, the "classic" operating modes are available with response voltage at connection D5.

---

The actuators of the MF type can only be connected in PP mode, all others either in PP or MP mode.

---

Select the type of bus scan in the bus scan section of the "MP-Channel settings" dialog:

PP Only	Connection of a single actuator in PP mode
MP / PP	First scan address 1 to 8 or 1 to 16 in MP mode. If there is no response in MP mode, switch to PP mode.

#### Periodic bus scan

The periodic bus scan is active by default. To switch this off, click the MP-Channel with the right mouse button and select Interrupt scanning. Afterwards, you can switch the periodic scan back on again the same way with the menu item Scan Every xx Seconds.

#### Manual bus scan

Manually activate an immediate bus scan with the function button F5 ("Update") as needed. This is possible at any time, even when the periodic bus scan is active.

Variante You can also select MP-Channel ▶ Trigger Scan in the main menu or activate the Trigger scan function by clicking the MP-Channel with the right mouse button.

If more than one actuator responds at the same MP address during a bus scan or if more than one actuator is connected in PP mode, a bus jam will occur. This situation is indicated by the program with a corresponding message.

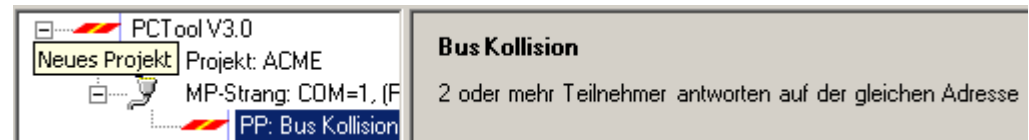

If during the bus scan an active external master is recognized, the channel will be closed. This situation is indicated with the according message.

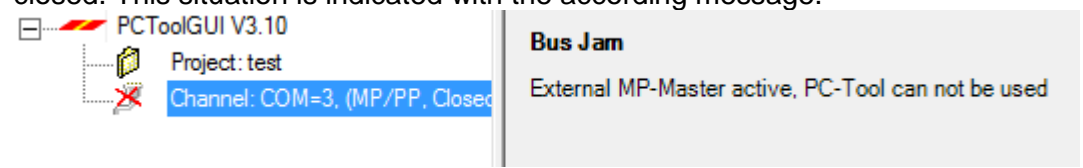

Saving a bus scan overview in a file

The result of a bus scan can be saved in a file for recording. Select "Channel" in the outline bar to show an enumeration of all found MP nodes with the corresponding data (address, position, type, designation and serial number).

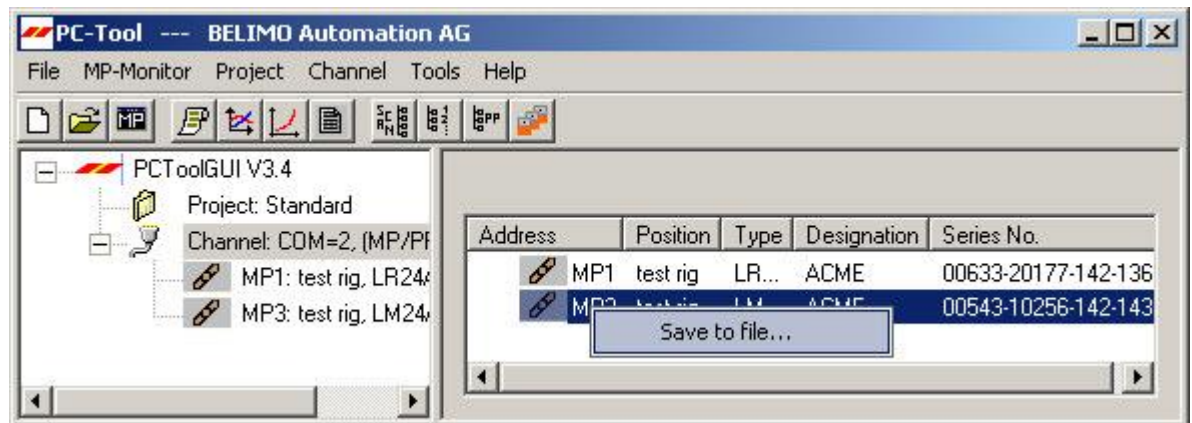

Saving the bus scan overview

Click the right mouse button to open the context menu and choose "Save to file" for saving the information in a text file.

### 3.4 Setting the bus address

Each actuator with an MP-Bus interface (valid for all devices with an MP-Bus interface, e.g. I/O modules, etc.) can be assigned an address which it will use to communicate on the MP-Bus.

The setting of the bus address can be disabled on certain actuators, e.g. for the actuator types ...LON and ...ALON (for LONWORKS®).

By default an address can be assigned between MP1 and MP8. Through a parameter change in the configuration file "PCToolGUI.exe.config" the address range can be extended up to MP16. Valid values are MP8 and MP16, all other entries are treated as MP8.

### 3.4.1 Series addressing of actuators



Click the Address device icon in the toolbar [B].

Variant Click the MP-Channel with the right mouse button and select Addressing Device. Or select MP-Channel ▶ Addressing Device in the main menu.

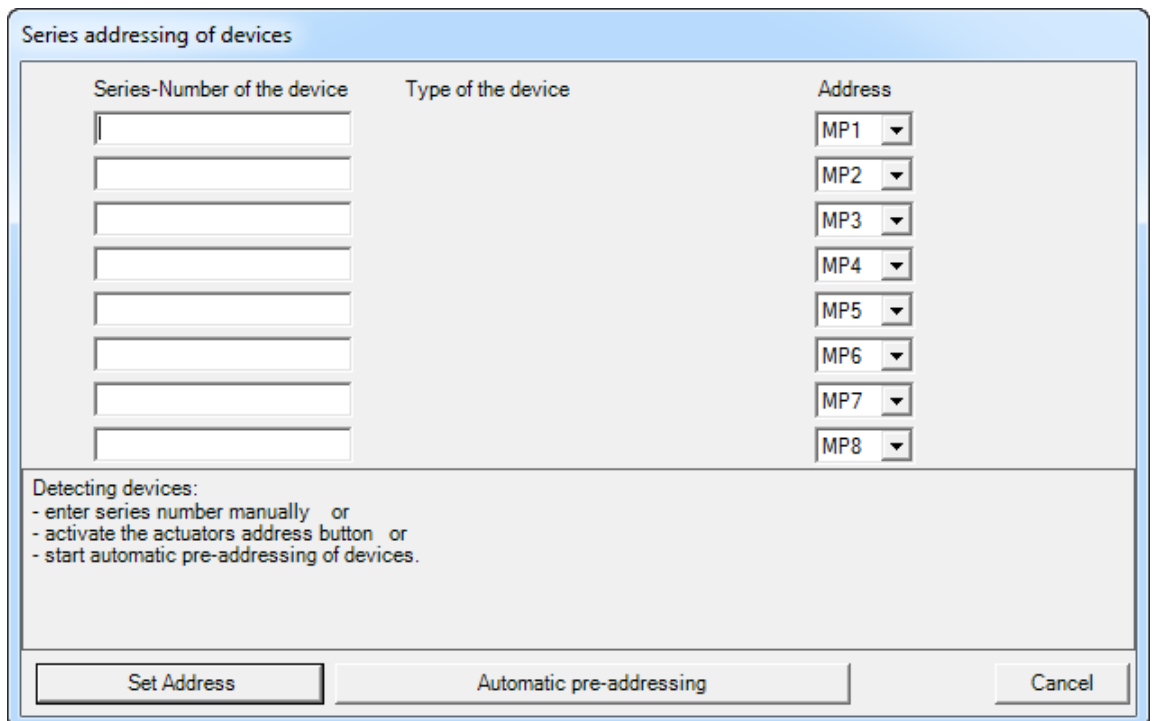

#### Series addressing

If you want to use something other than the default order, then select the desired addresses in the comboboxes on the right.



Reading in the serial numbers with acknowledgement on the actuator

Then press the acknowledge button on the actuator that is to receive the first address. Depending on the type of actuator, this is the manual button, the L/R change-over switch, the manual control or the S2 button. (If the buttons are not accessible, enter the serial numbers directly as described below.)

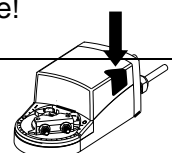
Actuator family	Actuator type	Acknowledge function
Actuators without	NM24-MFT(2) AM24-MFT(2)	Press manual button once!



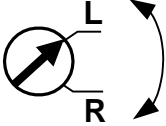

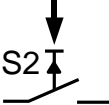
spring return	GM24-MFT(2)	
Actuators with spring return	LF24-MFT(2) AF24-MFT(2)	Move L/R switch back and forth once (within 4 seconds!) 
Actuators for fire & smoke dampers	BF(G)24TL-T-ST	Turn the manual control for about 1/6 in direction "Unlock"  and release the crank. 
Linear actuators for valves	NV24-MFT(2) NVF24-MFT(2) NVF24-MFT(2)-E	Actuate button S2 (under the housing cover) once! 
Actuators of the New Generation	...MP ...MF ...ALON	Actuate the "Address" button

The serial number of the actuator is read out after the acknowledgement and written into the input box. The cursor jumps to the next line.

Repeat this process for all actuators that are to be addressed and then click "Set address".

If one of the addresses is already assigned to another actuator, a message will be displayed:



*Message when an address is already assigned (series addressing)*

Click Yes to initially release the address. The actuator that used to occupy the address is set to PP.

If you select No, the actuator will be set to the already assigned address and a bus jam can occur.

Click Cancel to stop the series addressing at this point. You can now rearrange the addresses or end the entire process.

### 3.4.2 PPX addressing

On this new addressing variant the program asks actively for actuators, which support PPX and they are not MP addressed yet. First ,wins' and will be recognized. In order that can be recognized all actuators, the application provides all found PP actuators automatically with a MP address. Since the "manual" variant is the "normal case", PPX scan doesn't start automatically but only when the button "Automatic pre-addressing" is pressed.

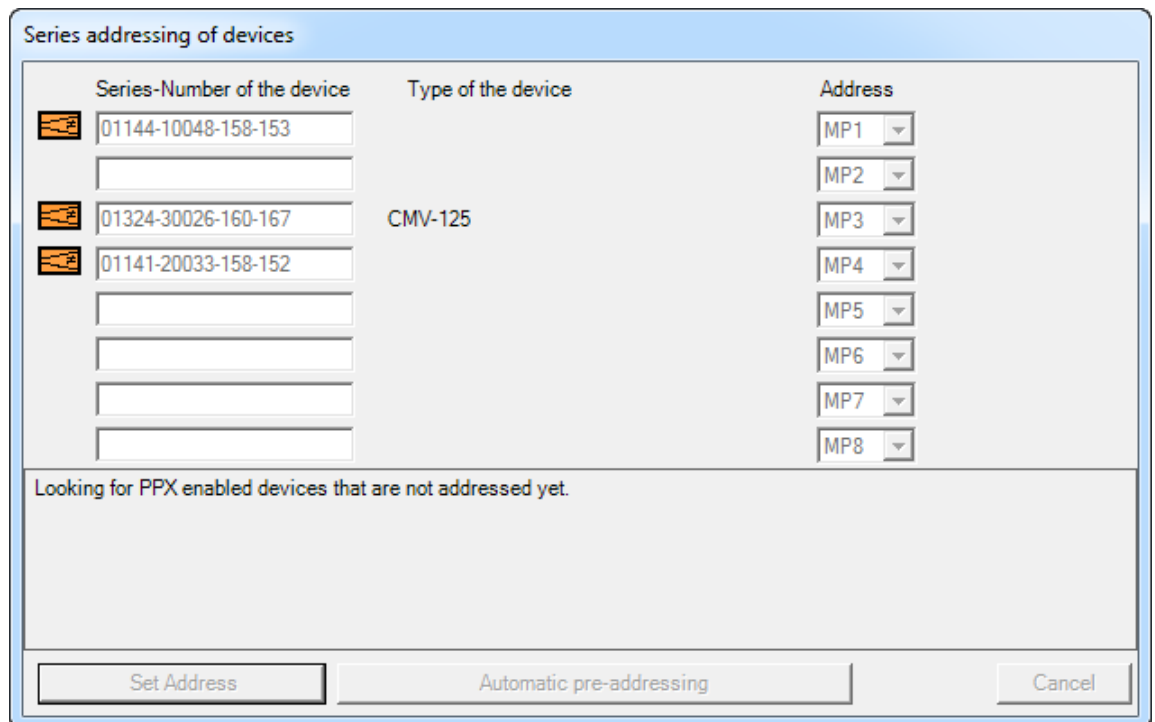

### 3.4.3 Addressing with known serial numbers

Each MP/MFT(2) actuator is delivered with a label containing its individual serial number. These serial numbers can be used to assign a PP or an MP1 ... MP8 address to the actuator. An additional, removable label with an identical serial number is supplied with the actuator. If the actuator is installed at a particular position in the system, this additional label can be affixed at the same position in the system diagram. This records where the actuator with the corresponding serial number is located in the building. These serial numbers can be used to assign the MP1 ... MP8 addresses to the actuators.

You can also fill in the input boxes manually before clicking Set Address, for example when the buttons of the actuators are not accessible or you regularly take the serial numbers from your documents.

### 3.4.4 Resetting actuator addresses

If you want to reset actuators with MP addressing to PP, click to the right of the MP-Channel and select "De-address Device" in the pop-up menu.

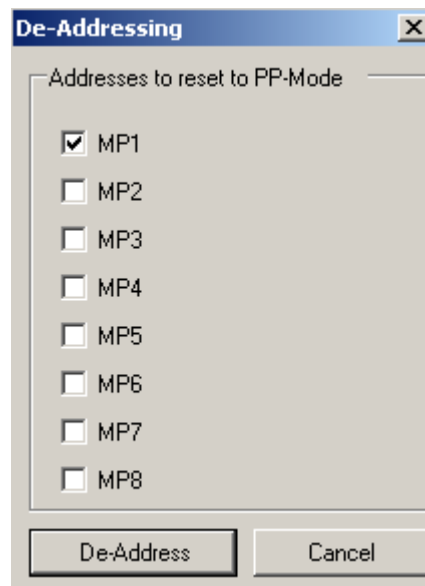

*Selection of the addresses to be reset*

Mark the addresses whose actuators are to be de-addressed.

---

When the bus scan is set to MP/PP, the de-addressed actuators are no longer visible in the outline bar [C] as long as there are still actuators with addresses.

If you set several actuators to PP, a bus jam will occur with the bus setting "PP only".

---

### 3.4.5 Addressing a single actuator



Select the actuator in the outline bar [C] and click the "Change MP Address" icon in the toolbar [B].

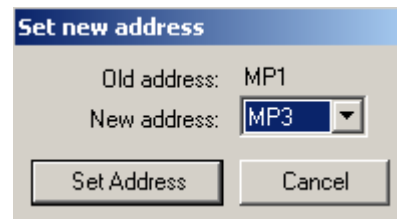

*Setting a new address*

**Variant** Click the actuator with the right mouse button and select "Change MP Address" ("MP-Adresse ändern").

Select the new address in the combobox. If the address is already assigned to another actuator, a message will be displayed:

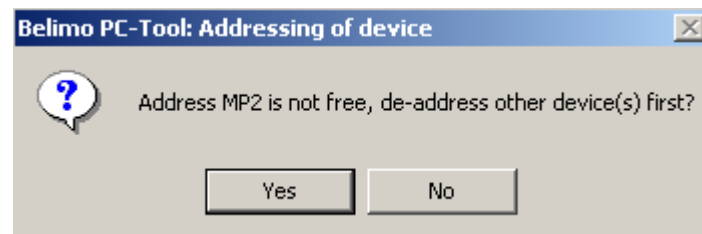

*Message when an address is already assigned*

Click Yes to initially release the address. The actuator that used to occupy the address is set to PP.

If you select No, the actuator will be set to the already assigned address and a bus jam can occur.

### 3.5 Selecting a module

All actuators that are active and connected to an MP-Channel are displayed in the outline bar [C]. Select the desired actuator from this display.



The type of actuator is indicated by the icon:

Icon	Actuator type
	Damper actuator
	Valve actuator
	Valve actuator NG
	Window ventilation actuator
	Actuator for fire dampers
	VAV (Variable Air Volume) controller actuator
	THC24-MP
	UST-3 I/O module
	EPIV Electronic Pressure Independent Valve
	MPL-Actuator
	Datapool device
	Unknown actuator

When an actuator is selected for the first time, the parameters are read out and displayed in the detail area [D].

In addition, the address for communication on the MP-Channel (MP or PP mode) and the name of the actuator type are displayed in the outline bar [C].

The complete information for identifying the selected actuator is found in the header of the detail area [D].

Type	<b>NM24-MFT2</b>	SN	<b>00449-20025-062-069</b>
Designation	<b>Inlet damper</b>	Address	<b>MP1</b>
Position	<b>Room1</b>		

*Display of the actuator identification*

---

Note the difference between the current communication mode on the MP-Channel and the displayed address. An actuator with the address MP2 can be activated in PP mode during a bus scan, for example.

---

### 3.6 Actuator parameters

#### 3.6.1 Displaying actuator parameters

The parameters of an actuator are displayed on the Service tab in the detail area [D].

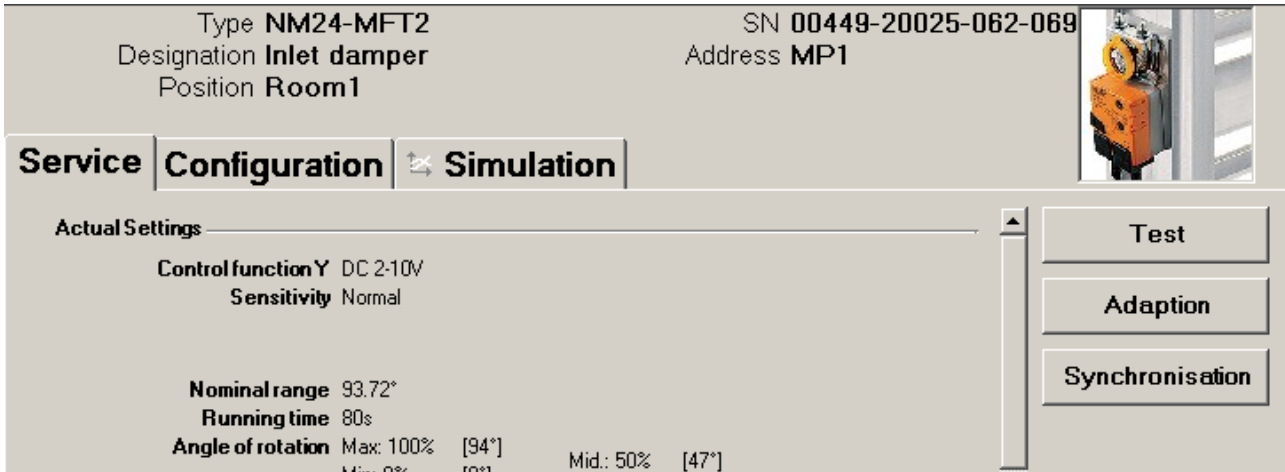

Example of the "Service" tab (damper actuator)

The Test, Adaptation and Synchronization functions are described for each respective module.

#### 3.6.2 Printing out actuator parameters

The displayed actuator parameters can be printed out. Click the printer icon in the toolbar [B] or select Print Actuator Parameters in the pop-up menu after clicking the actuator in the outline bar [C] with the right mouse button.

#### 3.6.3 Deleting maintenance/error messages

When an actuator has created and saved maintenance or fault messages, these are displayed on the Service tab.

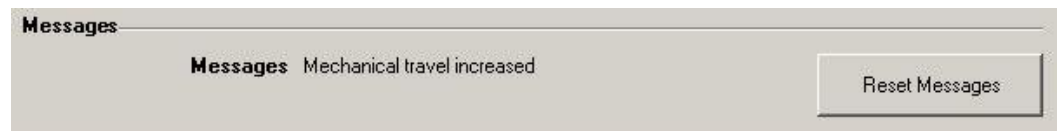

Message display on the Service tab

Use "Reset messages", to delete the messages stored in the actuator.

Following messages may appear:

Message	Description
Mechanical travel increased	Expected end stop value for top or bottom has been overrun.
Mechanical overload	Actuator did not reach set point because an obstacle has reduced the operating range
Excessive utilisation	Actuator moves to often compared with the total operating time (typical relation of active time to operating time is greater than 20%)
Fail-Safe failed	The Fail-Safe module is defect (e.g Super Cap module). This message cannot be deleted. The defect actuator has to be replaced.

Actuators for fire & smoke dampers have provide a larger scale of messages. The specific messages are described in the Fire & Smoke module.

### 3.7 Configuring an actuator

To change the parameters of an actuator, go to the Configuration tab.

The screenshot displays the 'Configuration' tab of the PC-Tool software. At the top, it shows the actuator's Type (D3 ohne Höhenkom), SN (01144-10048-158-153), and Address (MP1). Below this are three tabs: 'Service', 'Configuration' (selected), and 'Simulation'. The main configuration area includes input fields for 'Designation' and 'Position'. A 'Volume flow' section contains a 'Vnom' field set to 2000 m3/h. The 'Direction of rotation' section has radio buttons for 'ccw' (selected) and 'cw', along with a 'Mode' section with radio buttons for '0..10 V', '2..10 V', and 'other' (selected). A 'Reduce' button with an upward arrow is present. The lower section contains several dropdown menus: 'Angle of rotation' (programmed, 95°), 'Control type' (Open loop), 'Control signal Y' (DC 2-10 V), 'Bus fail position' (Close), 'Sensitivity' (normal), 'Synchronization at' (Y=0%), 'Leakage Switch' (off), 'CAV feature' (Standard, 0.1V shut off), 'Power ON' (No action), and 'Torque' (100%). A 'Gear release button' dropdown is set to 'Synchronization'. On the right side, there are three buttons: 'Read', 'Write', and 'Store to file...'. A small image of the actuator with a green checkmark is in the top right corner.

Example of the "Configuration" tab (damper actuator)





The lower area with the basic settings can be displayed with the "More..." button and hidden again with the "Less" button.

When you change a value in an input box, the box turns yellow:

A close-up of the 'Drehwinkel' (rotation angle) input field. The field contains the value '10' followed by '% (0.61%)'. The input box is highlighted in yellow, indicating that the value has been changed. Above the input box, the word 'Min' is visible.



The status image on the right additionally shows whether all the displayed values match those stored in the actuator:

Status	Display matches actuator Lackbit intact	Display matches actuator Lackbit broken / not supported	Values have been changed Lackbit intact	Values have been changed Lackbit broken / not supported
Image				

Status image

Save the changed values in the actuator with the "Set" button underneath the status image.

You can read out the parameters currently saved in the actuator again with the "Read" button. Entries for values that you have not previously saved in the actuator will be lost as a result.

### 3.7.1 Saving a parameter file

You can store the displayed parameters in a file (with the extension .btpar) with "Store to file..." on the "Configuration" tab. The suggested name for the file consists of the project, the actuator type, the position, the serial number, the current date and the time of day.

---

Since the content of the file corresponds to the values displayed on the screen, you can change individual values and save variants in files without loading them on the actuator.

---

The file can only be saved when all values on the screen are valid.

---

### 3.7.2 Loading a parameter file

The values of a saved parameter file can be read back into the input screen for the configuration with "Load from file...".

### 3.7.3 Copying parameters

Read out the parameters of an actuator that you want to copy and save them in a file. Change the actuator, load the saved parameters from the file and program the actuator with the copied values.

### 3.7.4 Load factory settings

When a project is created, two folders are created in the parameter directory. These folders contain the factory settings for all supported actuator types.

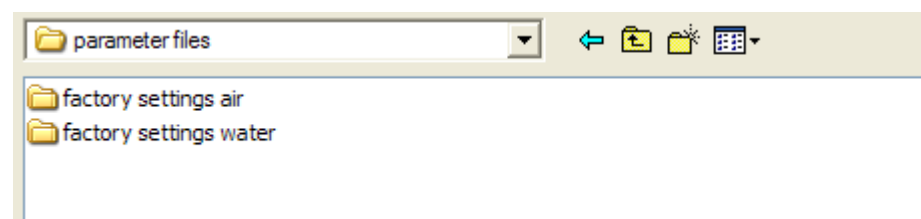

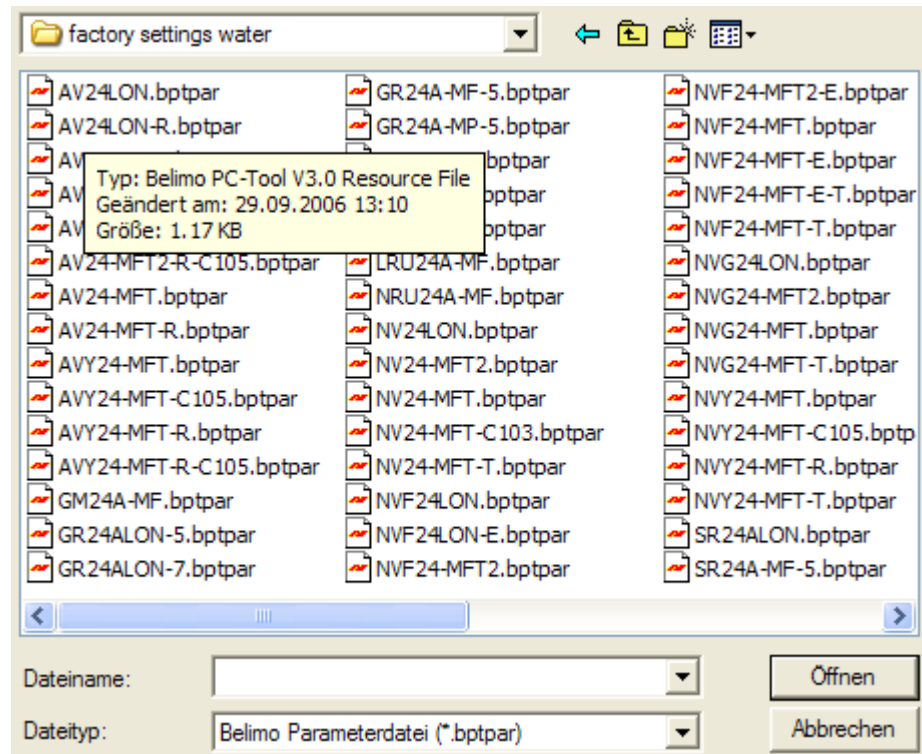

*Parameter files with factory settings*

Open the file which matches the actuator type. The settings are loaded into the input screen for the configuration. Afterwards, store the parameters in the actuator with the "Set" button.

### 3.8 Parameterizing limited lots

You can parameterize several identical actuators with the function "Parameterize Limited Lots". The number depends on the power of the voltage supply.

To parameterize limited lots, save the parameter set to be programmed in a file.

With one parameter set, you can only program actuators from the same actuator family (e.g. MFT or NMV), i.e. the parameter set used must match the actuator family.

Connect the devices according to the following wiring diagram (for further wiring diagrams, see clause 4.4 Typical wiring diagrams):

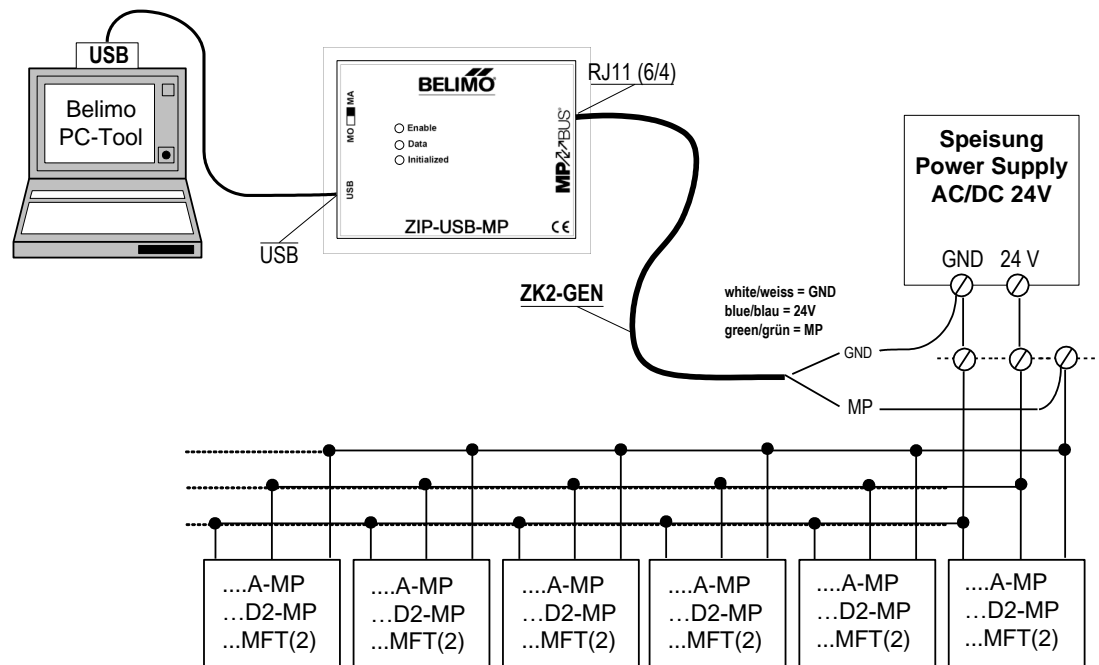

Select the desired MP-Channel and click the symbol "Parameterize Limited Lots".

Variant

Click with the right mouse button on the MP-Channel and select Parameterize Limited Lots. Or select the MP-Channel ▶ Parameterize Limited Lots in the main menu.

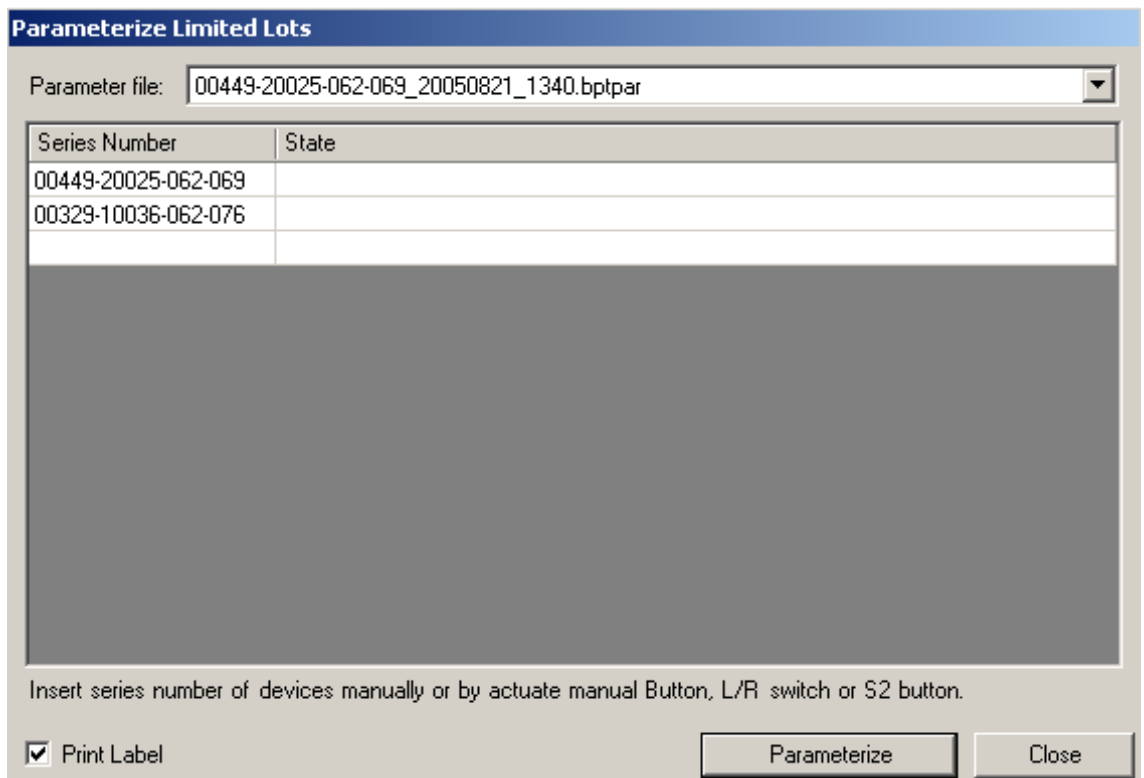

*Dialog for parameterizing limited lots*

Select the file with the saved parameters in the dialog.

Position the cursor in the first input box for the serial number. Then press the acknowledge button on the first actuator which should be parameterized. If the buttons are not accessible, directly enter the serial numbers as described below.

The serial number of the actuator is read out after the acknowledgement and written into the input box. The cursor jumps to the next line.

Repeat the process for all actuators that are to be parameterized and mark the checkbox if you want to print labels after parameterization (see Section 3.9 "Printing labels").

Click Parameterize.

The PC-Tool now asks for the file with the values to be written into the actuators.

The periodic bus scan is stopped for the duration of the parameterization. The actuators are successively set to the address MP1, programmed and finally set to PP addressing.

When the bus scan is set to MP/PP, the actuators in the outline bar [C] will not be visible. If the bus setting PP Only is used, a bus jam will result.

If an error occurs during programming, a corresponding text is displayed in the "State" column.

If the address MP1 is already assigned to an actuator, a message will be displayed:

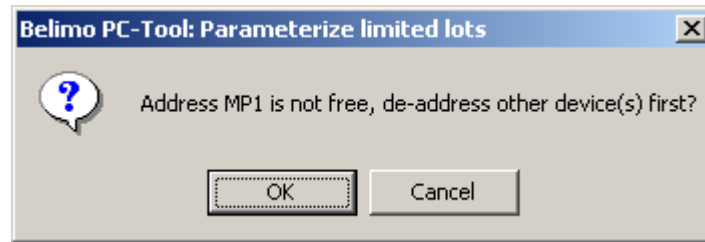

*Message when the address MP1 is already assigned (limited lot)*

Click OK to initially release the address MP1. The actuator that used to be assigned to this address will be set to PP.

Click Cancel to stop the parameterization at this point.

#### Identification with known serial numbers

You can also fill in the input boxes manually before you click "Parameterize", for example when the buttons of the actuator are not accessible or you regularly take the serial numbers from your documents.

#### Programming further series

The actuators that have been successfully programmed are deleted from the list. You can register further serial numbers in the list and then click "Start parameterization" again.

### 3.9 Printing labels

To identify actuators, you can write self-adhesive labels with the PC-Tool program. A special printer may be necessary, depending on the type of label.

#### 3.9.1 Setting up a configuration file

Labels are defined per project. To print labels, set place holders (number in brackets) in the configuration file for the information to be printed.

---

The structure and storage location of the configuration files are described in the Appendix.

---

#### 3.9.2 Printing labels



Select an actuator and click the "Print Label" icon (with an orange background).

Variant Click an actuator in the outline bar [C] with the right mouse button and select "Label Printing".

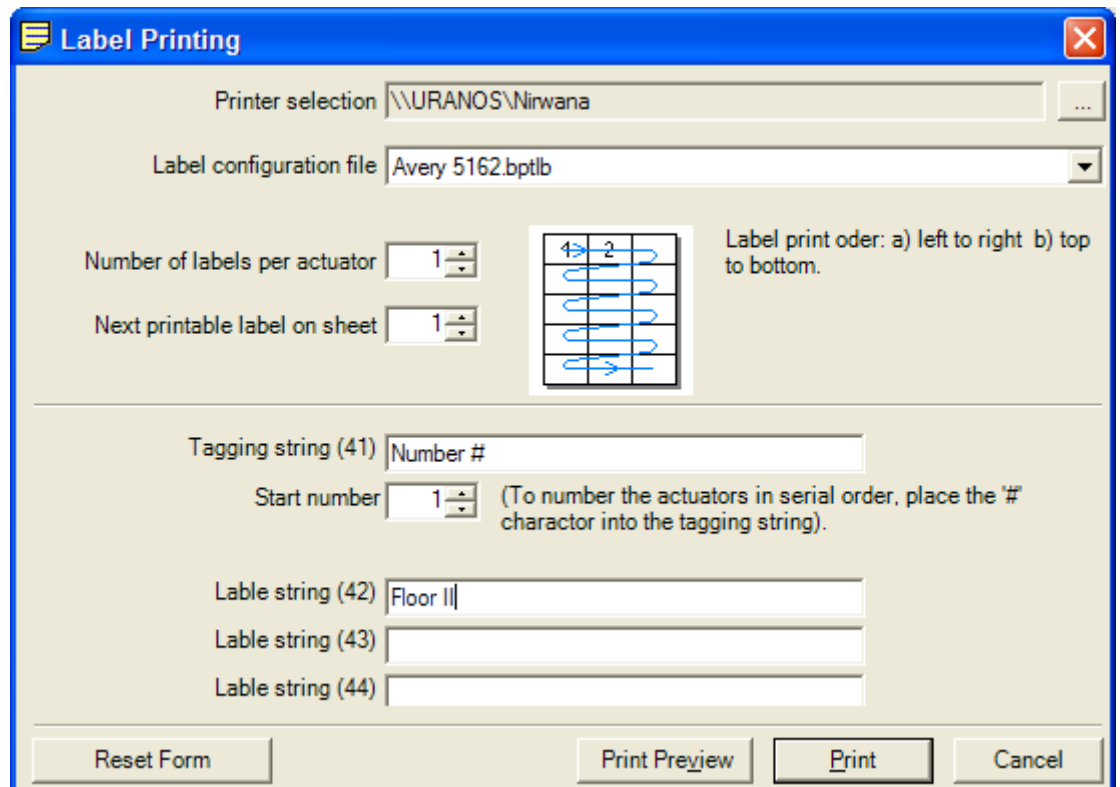

*Label printing dialog*

Select a printer and a configuration file.

Enter the number of identical labels that are to be printed for "Number of labels per actuator". When parameterizing limited lots, the total number of printed labels is equal to this value times the number of actuators.

Enter the desired texts {41} – {44} that are to be printed, if necessary. A maximum of 50 characters are available per text box. In text with consecutive numbering, a number is entered instead of the place holder "#". This number is increased by one for each new actuator.

If labels have already been used from a label sheet, you can specify at what label position the printing should start (for example 4 when 3 labels have been used from the first row).

Your entries and the selected printer are preserved from one label printing process to the next (automatic saving). You can empty the input boxes with Reset Form.

---

The texts {41} – {44} must be present in the label configuration file in the form of place holders. Otherwise, they will not be printed out.

---

### 3.9.3 Printing labels offline

Labels can still be printed even if no actuator is connected. In this case, only the information from the project data, the texts entered in the dialog and the current date can be output. The start number is always used instead of the place holder #.



Click the "Print label" icon (with gray background).

Variant

Click the project in the outline bar [C] with the right mouse button and select "Label Printing". Or select Project ▶ Print Label in the main menu.

For Number of labels per actuator, enter the number of identical labels to be printed. The number with the placeholder "#" is NOT counted up. The further procedure is the same for printing actuator labels.

## 3.10 Transformation tables

Transformation tables are for converting the sensor value into another physical quantity, for example from resistance (in ohms) to temperature (in °C) for NTC resistors. Several frequently used transformation tables are supplied with the program.

Selecting a transformation table

Select a transformation table with the combobox. The corresponding converted value is displayed underneath the sensor value.

---

The measured sensor variable in the table must match the selected sensor type: volts for active sensors, ohms for sensor resistors, on/off for switches.

---



Adapting a transformation table



Click the transformation table icon.

Variante

Click the project in the outline bar [C] with the right mouse button and select Transformation table. Or select Project ▶ Transformation table in the main menu.

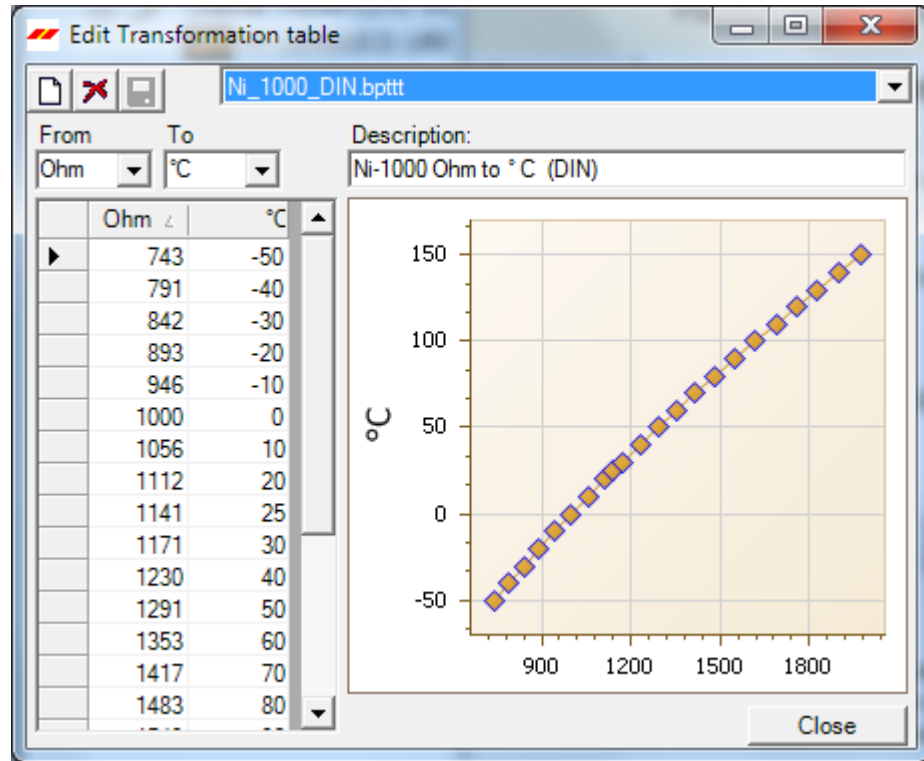

Dialog for editing transformation tables

Select an available transformation table using the combobox.

The sensor values and the converted values are displayed in the table on the left. On the right, you see a corresponding diagram with the sensor values on the horizontal axis and the converted values on the vertical axis. The table values are *linearly interpolated*; in other words, the points are connected by straight lines to calculate intermediate values.

During conversion, the first and last connection lines are extended beyond the range of entered points (*extrapolated*) so that even sensor values outside of this range are valid.

You can adapt each value in the table or add new value pairs in the last line, which is marked with an asterisk (\*). Newly added value pairs are automatically sorted into the right place.

---

The following holds true for switches: Off = 0, On = 1.

---



Save the changes to the transformation table by clicking on the floppy disk icon.

---

When you change a transformation table in one project, the changes do not affect corresponding tables in other projects. However, you can return to the original project folder from all projects through the entry <Other...> in the combobox and open the changed table.

---

#### Setting up a new transformation table



When the dialog for editing a transformation table is open, you can create a new table with the "New" icon. Select the physical quantities for the sensor values and the converted values in the comboboxes above the table. You can also write any other quantities into the text boxes of the comboboxes.

---

For the sensor values, only volts, ohms and on/off are meaningful input quantities, because only these sensor types are supported.

---

Enter a description in the text box and add new value pairs in the last line of each table, which is marked with an asterisk (\*). A transformation table must have at least two lines.

---

For switches, you can define an on/off inversion table with the assignments  $0 \rightarrow 1$  and  $1 \rightarrow 0$ .

---



Save the new transformation table by clicking on the floppy disk icon. The name that you enter in the "Save file as" dialog will be subsequently offered as a selection in the combobox.

---

If the name of the new table does not appear in the combobox on the "Simulation" tab, open the project again.

The new transformation table is not directly available as a selection in the combobox in other projects. However, you can return to the original project folder from all projects through the entry <Other...> in the combobox and open the new table.

---

#### Deleting a transformation table



When the dialog for editing a transformation table is open, you can use the Delete icon to delete a table that has been selected in the combobox.

---

If the name of the deleted table still appears on the "Simulation" tab in the combobox, open the project again.

---

### 3.11 Displaying recorded trend data



Click the symbol Trend display.

**Variant** Click the project in the outline bar [C] with the right mouse button and select "Trend Recall". Or select Project ▶ Trend Recall in the main menu.

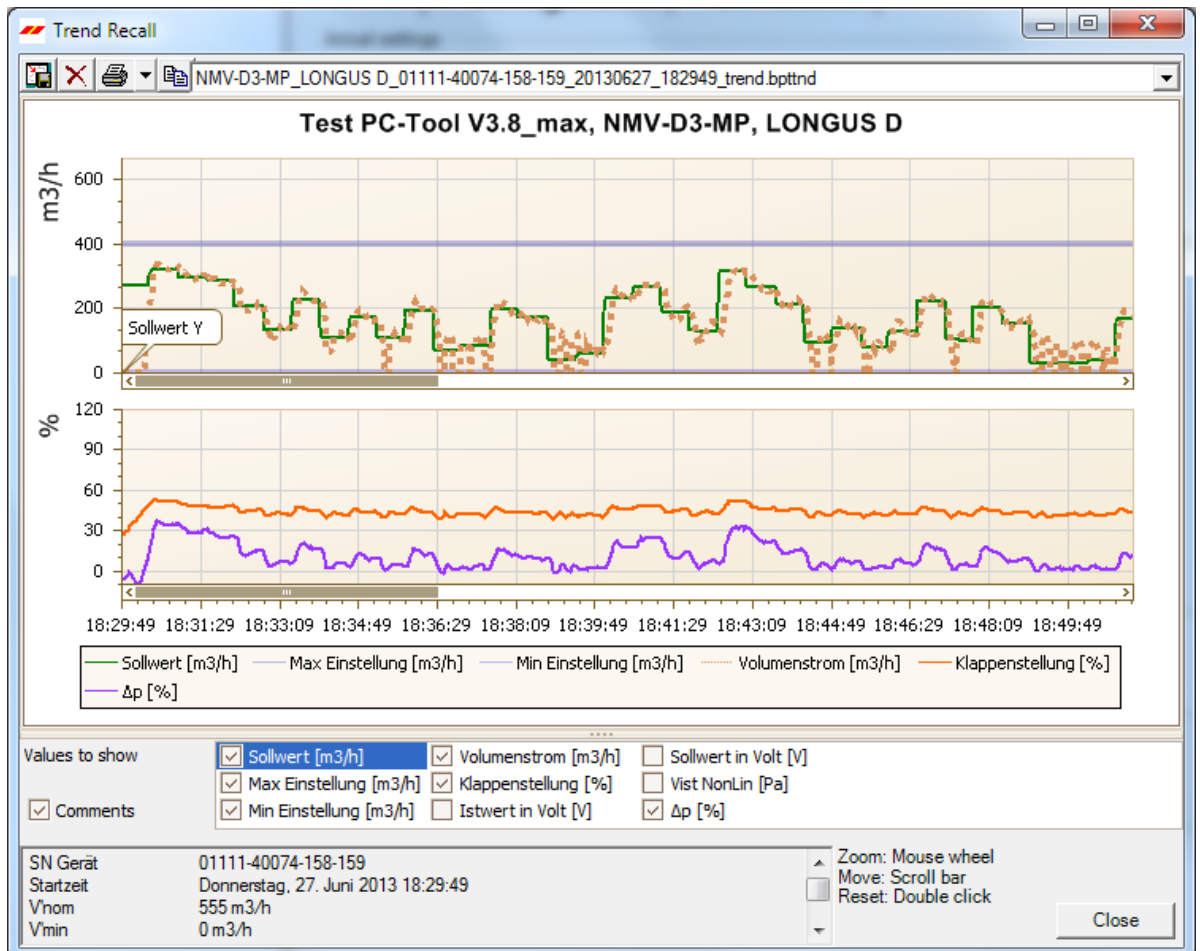

#### Trend recall

Select a trend file with the combobox.

To zoom in use the mouse wheel. Pull the diagram to the left or right with the mouse in order to display values for other times.



You can use the copy button to insert the diagram into other documents via the clipboard.



Use the save button to fix the window size of the trend display.

#### Printing a trend

Click the Print icon or press the key combination CTRL-P.

**Variant** In addition to the Print button, you can open a menu with the "down" key. In addition to printing, this allows you to display a preview or select several files for printing with "Print multiple".

With "Print multiple (without comments)" the comments will only be showed in the comment list, not inside the trend graphic.

#### Graphs

On the bottom of the trend window different curves can enabled and disabled. The selected curve is drawn directly into a new or existing coordinate system (depends on the necessary units).PC-Tool options

### 3.12 PC-Tool options

Select Tools►PC-Tool options... in the main menu.

Variant Click the project in the outline bar [C] with the right mouse button and select PC-Tool options...

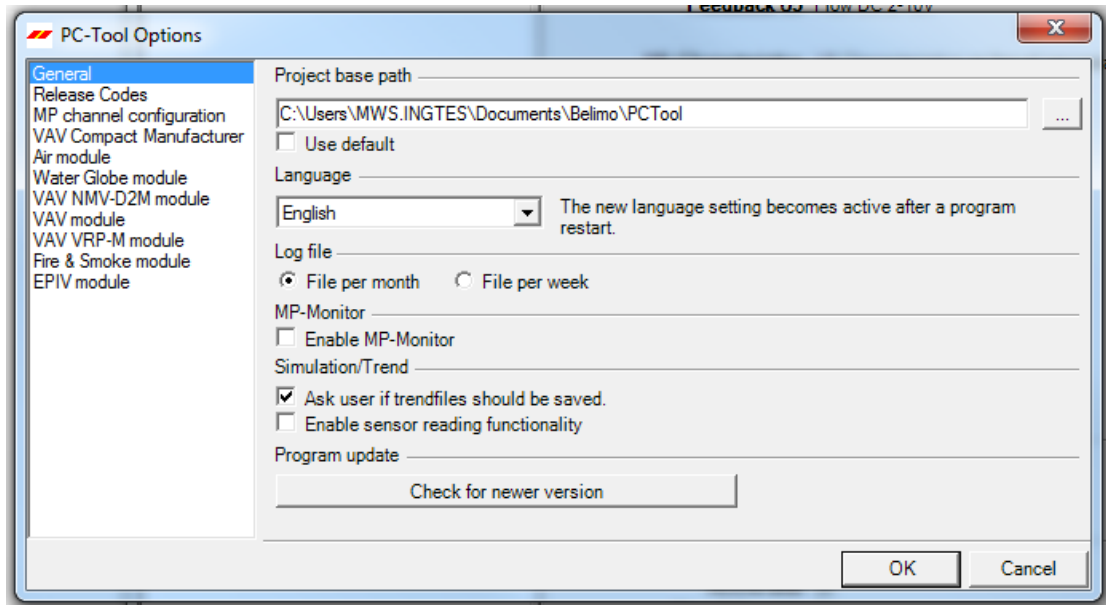

Dialog for basic settings (general)

"Project base path" sets the default directory in the file system, in which the new project folder will be saved. You can override this information when creating new projects, however.

When you mark the "Use default", checkbox, new projects will be saved in your user profile under "My Documents". With the operating system Microsoft Windows XP (English), this folder is located under

C:\Documents and Settings\<Name>\My Documents.

You can open the folder "My Documents" with the "My Computer" icon.

The language that you select in the combobox will be used the next time that you start the program.

Under "Log file", you can define whether a separate log file should be created each month or each week.

Mark the "Activate MP-Monitor" checkbox to monitor the communication with the actuators with the diagnostic tool.

To check manually for a new program version there is an **update** function available. The program compares the current version with the Belimo update server. On each program start, if there is an internet connection available, the current version will be checked automatically.

In addition to "General", the names of the supported modules (actuator families) are displayed on the left side. Further information on the module-specific settings is found in the corresponding sections of this manual.

## 3.13 Log file

All activities with the PC-Tool software that influence the data stored in the actuator are recorded in a separate log file for every project. The time of each action is logged.

### Configuring the log file

You can create a separate log file for each week or month of a project (default: File per month). To change this setting, select Tools►PC-Tool options in the main menu. You can select either 'File per week' or 'File per month' under 'General'.



### Reading the log file

Click the "Read log file" icon in the toolbar.

#### Variants

Click the project icon in the outline bar [C] with the right mouse button and select Read log file. Or select Project ►Read log file in the main menu.

Using the combo box 'Log file', you determine the file to read. The contents of the log file are displayed in a table in the top section (each action starts a new row).

By clicking a column title, you can sort the table according to the selected column. By clicking again on the same column title, the sorting direction is reversed: increasing (A-Z) or decreasing (Z-A).

### Details

Click a table row to display details of this action in the bottom section.

You can print the text in the detail area ("Print..." button) or copy it to the clipboard ("Copy" button) and then paste it into another document.

**Read logfile**

Log file: M-2006-02.bptlog

Log events:					
Date/Time	Event	Position string	Type	Series no.	MP-Adr
02.02.2006 09.42:31	Read all parameter	P-10001	LF24-MFT2	00404-10097-080-09	PP
02.02.2006 09.42:31	Write all parameter	P-10001	LF24-MFT2	00404-10097-080-09	PP
02.02.2006 11.27:05	Read all parameter	P-10001	LF24-MFT2	00404-10097-080-09	PP
02.02.2006 11.31:20	Read all parameter		NMV-D2-MP	00603-30024-146-13	MP4
02.02.2006 14.42:16	Read all parameter		NMV-D2-MP	00603-30024-146-13	MP4
02.02.2006 14.43:09	Read all parameter	My position	SM24A-MP	00534-00026-142-12	PP
02.02.2006 16.05:21	Read all parameter	My position	SM24A-MP	00534-00026-142-12	PP
02.02.2006 16.05:31	Read all parameter	My position	SM24A-MP	00534-00026-142-12	PP
02.02.2006 16.09:04	Read all parameter	My position	SM24A-MP	00534-00026-142-12	PP
02.02.2006 16.09:10	Read all parameter	My position	SM24A-MP	00534-00026-142-12	PP
02.02.2006 16.36:10	Read all parameter		ΔF24I ON	00413-10019-084-08	MP1

Key	Value
Date/Time	02.02.2006 14.42:16
Event	Read all parameter
Position string	
Type	NMV-D2-MP
Series no.	00603-30024-146-139
MP-Adresse	MP4
Project name	testproj_tmp
-----	-----
SN	00603-30024-146-139
Type	NMV-D2-MP
Designation	
Position	
Address	MP4
Control type	VAV-CAV
Calibration value	3628
Volumetric flow setting	V'nom: 3303 m3/h, V'mid: 1652 m3/h V'min: 0 m3/h, V'max: 3303 m3/h
CAV feature	Standard
Control function Y	DC 2-10 V
Sensitivitu	normal

Copy    Print...    Close

## 4 Attachment

### 4.1 Storage locations of files

#### 4.1.1 Project data

The default project is stored as a "Default project" sub-directory in the installation directory of the program.

The projects are user-specific and are stored as a sub-directory in the user profile. For an English-language version of Windows, this is

C:\Documents and Settings\<Name>\My Documents\Belimo\PCTool

This directory contains sub-directories with the project names.

#### 4.1.2 Configuration files

The user-specific settings are stored in the user profile under "Application data". For an English-language version of Windows, this is

C:\Documents and Settings\<Name>\Application Data\Belimo\PCTool

This directory can be "hidden" under Windows. If it is not present, the settings will be queried upon starting.



## 4.2 Configuration files for printing labels

### 4.2.1 Storage location

The filenames have the extension \*.bptlb. They are saved in the "label definition" directory for each project. For an English-language version of Windows, this is

```
C:\Documents and Settings\<<Name>\My Documents\Belimo\PCTool\ <Project>\label definition
```

### 4.2.2 Format

The configuration files for label printing are stored in XML format. You can edit these files with an editor program, for example "Notepad".

Configuration files for common Avery and Zweckform labels are supplied with the program.

#### Example of a configuration file

```
<?xml version="1.0" encoding="utf-8"?>
<LabelDefinition xmlns:xsd="http://www.w3.org/2001/XMLSchema"
xmlns:xsi="http://www.w3.org/2001/XMLSchema-instance">
  <PageSize Height="278" Width="214" />
  <PageBorder Top="18" Left="5" />
  <LabelSize Height="33" Width="100" />
  <LabelBorder Top="5" Left="5" />
  <LabelLogo Path="Logo.bmp" Top="0.5" Left="2" Height="15.8" Width="41"/>
  <Lines>
    <Line Text="" />
    <Line Text="{0} / {1}" />
    <Line Text="{20}" />    <Line Text="{21}" />
    <Line Text="{23}" />
    <Line Text="{41} / {42}" />
  </Lines>
</LabelDefinition>
```

### 4.2.3 Boxes

You can adapt the values for the page layout (values in millimeters) for new label formats.

PageSize	Page size (height and width)
PageBorder	Border width (top and left) = distance from the top left corner of the first label to the page border
LabelSize	Size of an individual label
LabelBorder	Label border width (top and left) = distance of the lettering from the label border
LabelLogo	<p>It is possible to print a Logo (picture) on the label.</p> <p>Path: Here the path relative or absolute is entered for the Logo File: (Logo.bmp) or (C:\pictures\Logo.bmp)</p> <p>Position (upper and left) = Positon of the bitmap relative to the upper left corner of the label (border not included)</p> <p>The bitmap will be printed over the &lt;Lines&gt;. Therefore optionally some blank lines must be inserted.</p>

In every line element <Line>, you can insert place holders where certain project and actuator characteristics will be added during printing.

{0}	Company name (from project data)
{1}	Project name
{10}	Actuator type
{11}	OEM designation
{12}	Position
{13}	Serial number
{14}	MP address
{20}	Control type Y
{21}	Feedback signal U5
{22}	Range of rotation min – mid – max
{23}	Running time
{24}	Direction of rotation (cw /ccw)
{25}	Bus fail position
{26}	Sensitivity
{27}	Synchronization at
{28}	Torque
{29}	Nominal range
{30}	Conductance
{31}	Vnom
{32}	Vmax
{34}	Vmin
{36}	Control fct.
{37}	Mode
{39}	Feedbackparameter U5 (Damper Position / Volumetric flow / $\Delta p$ )
{40}	Printing date
{41}	Text with consecutive numbering
{42}	Freely definable text 1
{43}	Freely definable text 2
{44}	Freely definable text 3
{50}	Switching point S1 in degrees (°)
{51}	Switching point S2 in degrees (°)
{52}	Setting damper free running test
{53}	Valve Size (EPIV-Modul)
{54}	Power Fail Delay (Super Cap)
{55}	Power Fail Position / Power off Position (Super Cap)
{56}	$\Delta p @ V_{nom}$ (VAV-Compact D3)
{57}	Boxtype Comment
{58}	Boxtype Comment1
{59}	Boxtype Comment2
{60}	Boxtype Comment3
{61}	Range of rotation min
{62}	Range of rotation mid
{63}	Range of rotation max

{64}	Altitude of plant
{65}	Altitude of calibration
{66}	Nominal pressure

You can define up to 50 lines. The program does not check whether the lines fit on a label.

When you define a new configuration file in a project, this configuration will not be directly available in other projects. However, you can return to the original project folder from all projects by using the entry <Other...> in the combobox, and then use the file.

#### 4.2.4 Example of a label

The following example results in a label having the dimensions width x height = 50 mm x 20 mm. The example is intended for an endless label printer that prints labels of the size 50 mm x 20 mm.

The company name, the project name, the actuator type, the type of control signal and the running time are printed on the label.

This data yields the following configuration file and the subsequently displayed label:

```
<?xml version="1.0" encoding="utf-8"?>
<LabelDefinition
xmlns:xsd="http://www.w3.org/2001/XMLSchema"
xmlns:xsi="http://www.w3.org/2001/XMLSchema-instance">
  <PageSize Height="20" Width="50" />
  <PageBorder Top="0" Left="0" />
  <LabelSize Height="20" Width="50" />
  <LabelBorder Top="5" Left="5" />
  <Lines>
    <Line Text="{0}" />
    <Line Text="{1}" />
    <Line Text="Type: {10}"/>
    <Line Text="{20} Running time: {23}"/>
  </Lines>
</LabelDefinition>
```

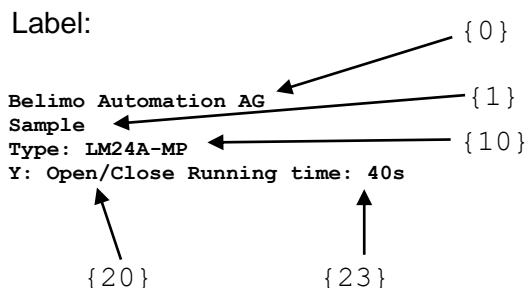

#### 4.2.5 Example of a label with Logo

The following example results in a label having the dimensions width x height = 65 mm x 45 mm. The example is intended for an endless label printer that prints labels of the size 65 mm x 45 mm. In the sample the "Belimo" logo has been inserted.

```
<?xml version="1.0" encoding="utf-8"?>
<LabelDefinition
xmlns:xsd="http://www.w3.org/2001/XMLSchema"
xmlns:xsi="http://www.w3.org/2001/XMLSchema-instance">
  <PageSize Height="278" Width="214" />
  <PageBorder Top="10" Left="5" />
  <LabelSize Height="45" Width="65" />
  <LabelBorder Top="5" Left="3" />
  <LabelLogo Path ="Belimo_Logo_5_rgb.bmp" Top="0.5"
Left="2" Height="15.8" Width="41"/>
  <Lines>
    <Line Text="" />
    <Line Text="" />
    <Line Text="" />
    <Line Text="" />
    <Line Text="{0}" />
    <Line Text="{1}" />
    <Line Text="{11}" />
    <Line Text="V'nom:{31,10} ; ({30})" />
    <Line Text="Δp@V'nom:{56}" />
    <Line Text="V'max:{32,10} ; V'min:{34,10}" />
    <Line Text="Datum:{40,10:dd/MM/yyyy}" />
    <Line Text="{10}" />
    <Line Text="{12}" />
    <Line Text="Mode:{37}" />
    <Line Text="{41}" />
  </Lines>
</LabelDefinition>
```

The **yellow** highlighted text line shows, how a bitmap as logo can be inserted. One have to enter the path and file name of the bitmap (logo), the origin of the bitmap upper left and the size of the logo (height, width).

In this way several logos can be inserted in the label.

Label:

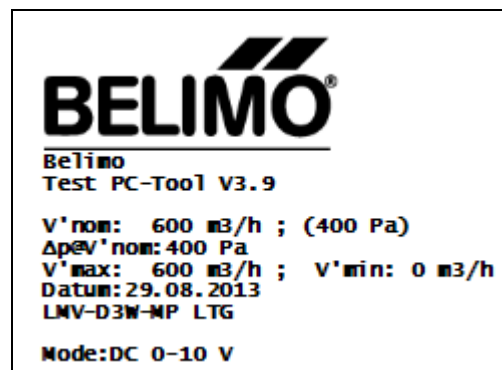

## 4.3 Troubleshooting and error messages

### 4.3.1 General

- Problem** After the program starts, an MP-Channel is not opened but displayed with the MP-Channel icon.
- Solution** The MP-Channel cannot be opened, for example because the selected serial interface is assigned to another application. Check whether a modem or a communication program is using this interface.

### 4.3.2 Error messages

<b>Error message</b>	<b>Description</b>
Start adaptation failed.	Communication failure on the MP-Channel or faulty actuator.
Actuator locked for PC-Tool.	The drive has been configured so that it can be neither read out nor programmed with the PC-Tool.
Summary: Actuator not reachable	Communication failure on the MP-Channel or faulty actuator.
Summary: Actuator run into timeout.	The drive did not respond within the specified time.
Answer has too much data.	Conflict between the actuator and program. The program library (belipp.dll) may not be up-to-date.
Answer doesn't have enough data.	Conflict between actuator and program. The program library (belipp.dll) may not be up-to-date.
Command has not enough parameters.	Conflict between actuator and program. The program library (belipp.dll) may not be up-to-date.
Command parameters out of range.	Conflict between actuator and program. The program library (belipp.dll) may not be up-to-date.
Belimo library error code = ....	Internal fault.
Description is missing	A transformation table must have a description.
Bus Jam	Two or more devices respond to the same address. Re-address the actuators.
This field is required!	This field must have an entry. It is not allowed to remain empty.
There is already an instance running!	The program cannot be started on a computer where it is already running.
Error while creating the project!	Check whether it is possible to write to the storage location of the project.
Error while copying default project.	When a new project is created, configuration files and sub-directories are normally copied from the default project in the installation directory of PC-Tool. The default project has probably been accidentally deleted, moved or renamed.
Default project directory '...' does not exist! Please reinstall the application.	When a new project is created, configuration files and sub-directories are normally copied from the default project in the installation directory of PC-Tool. The default project has probably been accidentally deleted, moved or renamed.

Error message	Description
Command ... unknown by the device	Conflict between actuator and program. The program library (belipp.dll) may not be up-to-date.
The value must be between ... and ....	The entry is not in the permitted range of values.
Invalid data answer from the device.	Conflict between actuator and program. The program library (belipp.dll) may not be up-to-date.
The difference is smaller than ....	A rule for the minimum difference between two values has been violated.
The length of the string must not exceed ... characters.	Shorten your entry.
MP-command ... unknown by PP_Function	Conflict between actuator and program. The program library (belipp.dll) may not be up-to-date.
A transformation table must have at least 2 points.	A transformation table must have at least 2 lines to be able to calculate intermediate values.
Not all parameters written to device	(Note the detailed instructions with the message regarding the reason for the error.)
Label print failed.	(Note the detailed instructions with the message regarding the reason for the error.)
Wrong device family ... instead of ...	When setting the parameters of small batches, an actuator from another actuator family was connected and does not match the parameter file.
Wrong transformation table for this sensor type. It cannot transform from unit ....	The transformation table does not have the measuring quantity of the sensor in the first column. Resistance sensors must convert 'ohm' into the target parameter, for example.
Wrong device connected!	This fault occurs when actuators are changed during parameterization. Read the parameters out again.
Wrong MP channel: '...'	The MP-Channel has changed.
Error starting testscript	The test script is invalid.
Label printing error	(Note the detailed instructions with the message regarding the reason for the error.)
Error loading transformation table	(Note the detailed instructions with the message regarding the reason for the error.)
Error while loading project file: ...	(Note the detailed instructions with the message regarding the reason for the error.)
Error reading parameter file	(Note the detailed instructions with the message regarding the reason for the error.)
Error opening Channel ....	(Note the detailed instructions with the message regarding the reason for the error.)
Error opening file explorer	File Explorer could not be started when displaying MP-Monitor files.
Error opening MP-Monitor	(Note the detailed instructions with the message regarding the reason for the error.)

Error message	Description
Error while saving test report!	(Note the detailed instructions with the message regarding the reason for the error.)
Error while processing line ... of the trend file ...	The trend file could not be interpreted. It was probably written manually.
Error: Invalid code for the module release.	Relates to the entry of the activation code. Please check your entry. All boxes must be filled-out according to the requirements.
Error: There is another device on MP1	Address conflict.
Error: Unable to change address to MP1	Address conflict.
Error: no answer from actuator	Communication failure on the MP-Channel or faulty actuator.
Address ... already set to this device!	Re-addressing re-assigns an already existing address.
Module release code expired!	Please contact your representative for a replacement of the code.
Character '...' is not allowed (not ISO-8859-1)!	Only characters from the Western European character set are permitted for Description and Position of an actuator (see table in Section 4.3.3).
No answer (possible bus jam).	Communication problem on the MP-Channel or faulty actuator.
No answer from device.	Communication failure on the MP-Channel or faulty actuator.
No label configuration file chosen.	Please choose a valid label configuration file and print a test label or uncheck print label after write.
No or empty setup string.	"Other" was selected when setting the communication parameters, but no connection was specified.
Could not deaddress other device	Address problem. (Note the detailed instructions with the message regarding the reason for the error.)
Couldn't write to the device!	Communication failure on the MP-Channel or faulty actuator.
Could not find the VRP-M Tool executable. Would you search for it now?	Concerns VRP-M controller. The corresponding program could not be found at the location specified in the PC-Tool options. Configure the path in the options (menu Tools/PC-Tool options in VRP-M).
Could not find PC-Tool V2.1. Would you search for it now?	Affects VAV actuators. The old version of the program could not be found at the location specified in the PC-Tool options.
Error while loading project.	(Note the detailed instructions with the message regarding the reason for the error.)
MP-Command ... failed.	Conflict between actuator and program. The program library (belipp.dll) may not be up-to-date. MP command could be password-protected.
MP-Channel was closed	The MP-Channel was closed during an asynchronously running function.
Not all data written to the device.	Communication problem during writing of the parameter data, possibly due to bus jam. Check the connection and addressing of the actuators. An MP command is password-protected or the actuator is not familiar with the command.



Error message	Description
Could not read all data from the device.	Communication problem while the parameter data was read, possibly due to bus jam. Check the connection and addressing of the actuators.
Not all fields have valid values! Can't write data	One or more input values in the "Configuration" tab is not valid. Look for a flashing exclamation mark. If you move the mouse pointer to the exclamation mark, an explanatory text (tooltip) with the valid range of values will usually appear.
OEM or BELIMO password necessary. Please contact OEM-Manufacturer	Parameters on the actuator can be protected with a password against changes. A password is necessary to overwrite them.
Parameter file contains no series number	When setting the parameters of small batches, the actuator family is checked by means of the serial number. The parameter file is old or has been changed manually.
Error opening configuration file	(Note the detailed instructions with the message regarding the reason for the error.)
Error storing configuration file	(Note the detailed instructions with the message regarding the reason for the error.)
Plausibility check: Failed. Please check the configuration dialog for further information.	Testing is not started if there are errors in the configuration.
Problems opening the MP-Channel "...".	Error at the interface. Check the communication parameters and the cabling.
Sending ... to ... returned error ...	Conflict between actuator and program. The program library (belipp.dll) may not be up-to-date.
Wrong format of serial number	You have made a typing error while manually entering the serial number. Check the notation of the serial number.
Series number has a wrong format!	You have made a typing error while manually entering the serial number. Check the notation of the serial number.
Reset alarm messages failed	Communication failure on the MP-Channel or faulty actuator.
Synchronization failed	Communication failure on the MP-Channel or faulty actuator.
The test script cannot be started because some conditions are not complied.	A certain minimum air flow or system pressure is necessary for the test. Please check fan and VAV box.
Start test run failed	Communication failure on the MP-Channel or faulty actuator.
New address could not be verified	The serial number is read before and after an actuator is re-addressed. These two numbers do not match. Another actuator probably answers to the programmed address.
Unknown MP-Channel '...'.	The MP-Channel could not be identified.
Invalid or corrupted parameter file '...'	The contents of the file could not be correctly interpreted. The format may no longer be valid. If possible, read out the parameters again and save them in a new file.
Invalid Series Number	The entered serial number was not found in any connected actuator.
Invalid value entered	Refer to the notes about the valid range of values.
Invalid value!	Refer to the notes about the valid range of values.

<b>Error message</b>	<b>Description</b>
Unspecific Belimo-Lib error	Internal fault.
Must be greater than zero.	Refer to the notes about the valid range of values.
Must be an integer.	Refer to the notes about the valid range of values.
Summary: Test cannot be executed due to active forced control	Remove the Y connection with the control signal for the duration of the test.
Two or more devices respond to the same address.	Bus jam Re-address the actuators.

### 4.3.3 ISO 8859-1/ANSI character set

Only characters from the ISO 8859-1/ANSI character set are permitted in the "Description" and "Position" box











Pos	Char	Pos	Char	Pos	Char	Pos	Char	Pos	Char	Pos	Char	Pos	Char
32		64	@	96	`	128	€	160	<sup>7)</sup>	192	À	224	à
33	!	65	A	97	a	129	•	161	ı	193	Á	225	á
34	"	66	B	98	b	130	, <sup>1)</sup>	162	ç	194	Â	226	â
35	#	67	C	99	c	131	f	163	£	195	Ã	227	ã
36	\$	68	D	100	d	132	„ <sup>2)</sup>	164	¤	196	Ä	228	ä
37	%	69	E	101	e	133	...	165	¥	197	Å	229	å
38	&	70	F	102	f	134	†	166	ı	198	Æ	230	æ
39	'	71	G	103	g	135	‡	167	§	199	Ç	231	ç
40	(	72	H	104	h	136	^	168	¨	200	È	232	è
41	)	73	I	105	i	137	‰	169	©	201	É	233	é
42	*	74	J	106	j	138	Š	170	ª	202	Ê	234	ê
43	+	75	K	107	k	139	‹	171	«	203	Ë	235	ë
44	,	76	L	108	l	140	Œ	172	¬	204	Ì	236	ì
45	-	77	M	109	m	141	•	173	- <sup>8)</sup>	205	Í	237	í
46	.	78	N	110	n	142	Ž	174	®	206	Î	238	î
47	/	79	O	111	o	143	•	175	¯	207	Ï	239	ï
48	0	80	P	112	p	144	•	176	°	208	Ð	240	ð
49	1	81	Q	113	q	145	‘ <sup>3)</sup>	177	±	209	Ñ	241	ñ
50	2	82	R	114	r	146	’ <sup>4)</sup>	178	²	210	Ò	242	ò
51	3	83	S	115	s	147	“ <sup>5)</sup>	179	³	211	Ó	243	ó
52	4	84	T	116	t	148	” <sup>6)</sup>	180	´	212	Ô	244	ô
53	5	85	U	117	u	149	•	181	µ	213	Õ	245	õ
54	6	86	V	118	v	150	–	182	¶	214	Ö	246	ö
55	7	87	W	119	w	151	—	183	·	215	×	247	÷
56	8	88	X	120	x	152	~	184	¸	216	Ø	248	ø
57	9	89	Y	121	y	153	™	185	¹	217	Ù	249	ù
58	:	90	Z	122	z	154	š	186	º	218	Ú	250	ú
59	;	91	[	123	{	155	›	187	»	219	Û	251	û
60	<	92	\	124		156	œ	188	¼	220	Ü	252	ü
61	=	93	]	125	}	157	•	189	½	221	Ý	253	ý
62	>	94	^	126	~	158	ž	190	¾	222	Þ	254	þ
63	?	95	_	127		159	ÿ	191	¿	223	ß	255	ÿ

The character positions marked with • are vacant.

- 1) Single speech mark, low
- 2) Double speech marks, low
- 3) Single left speech mark
- 4) Single right speech mark
- 5) Double left speech marks
- 6) Double right speech marks
- 7) Non-breaking space
- 8) Breaking hyphen

## 4.4 Typical wiring diagrams

### 4.4.1 Overview table

Cable	MP level converters and devices	Drawing	Page
<b>ZK1-GEN</b> 	 <b>ZIP-USB-MP</b>	Typical wiring diagram 1	52
<b>ZK2-GEN</b> 	 <b>ZIP-USB-MP</b>	Typical wiring diagram 2	52
		Typical wiring diagram 3	53
<b>ZK6-GEN</b> 	 <b>ZIP-USB-MP</b>	Typical wiring diagram 4	53
<b>ZKS-MP</b> 	 <b>ZIP-USB-MP</b>	Typical wiring diagram 5	54
<b>ZK1-VAV</b> 	 <b>ZIP-USB-MP</b>	Typical wiring diagram 6	54
		Typical wiring diagram 7	55
<b>Direct connection</b>	 <b>ZIP-RS232</b>	Typical wiring diagram 8	55

For further wiring examples with miscellaneous connection cables und level converters see [www.belimo.eu](http://www.belimo.eu) | Documentation | Bus- and System-Integration | "Tool connection guide"

### 4.4.2 Typical wiring diagrams

Typical wiring diagram 1

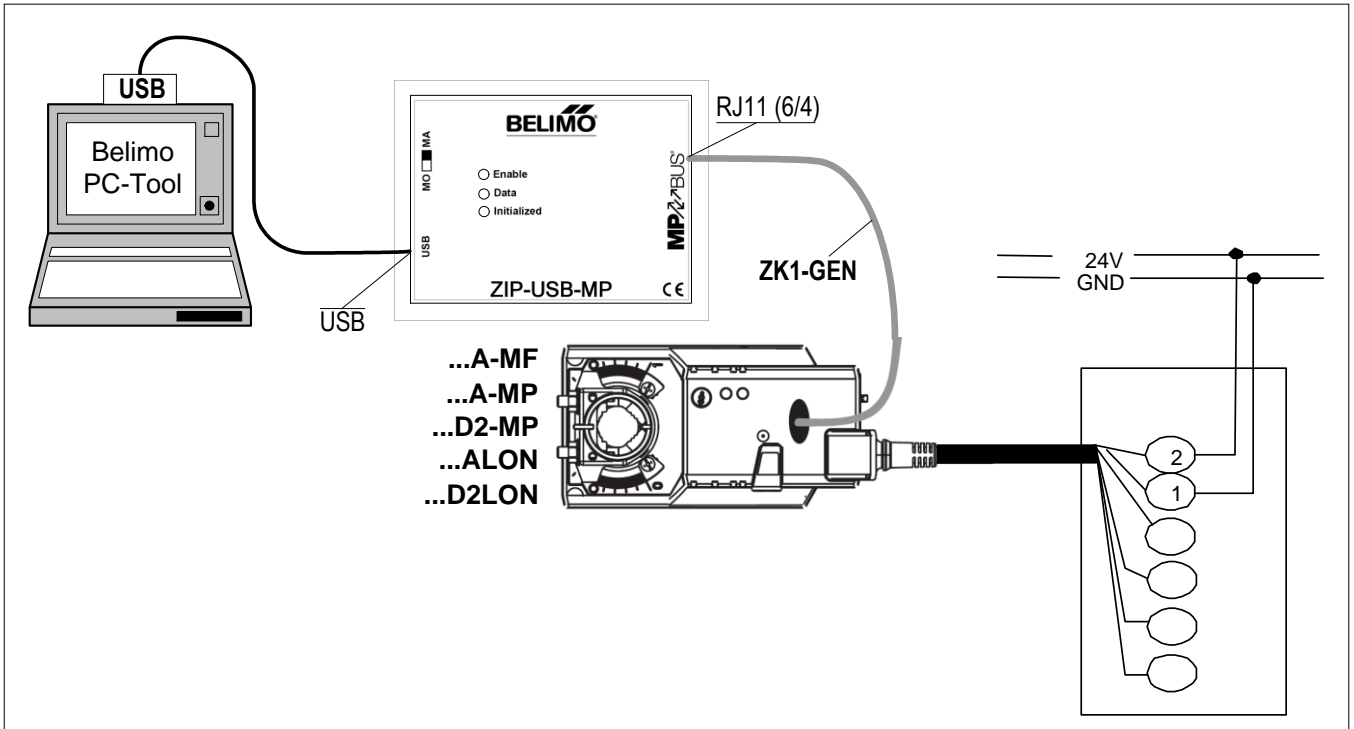

Typical wiring diagram 2

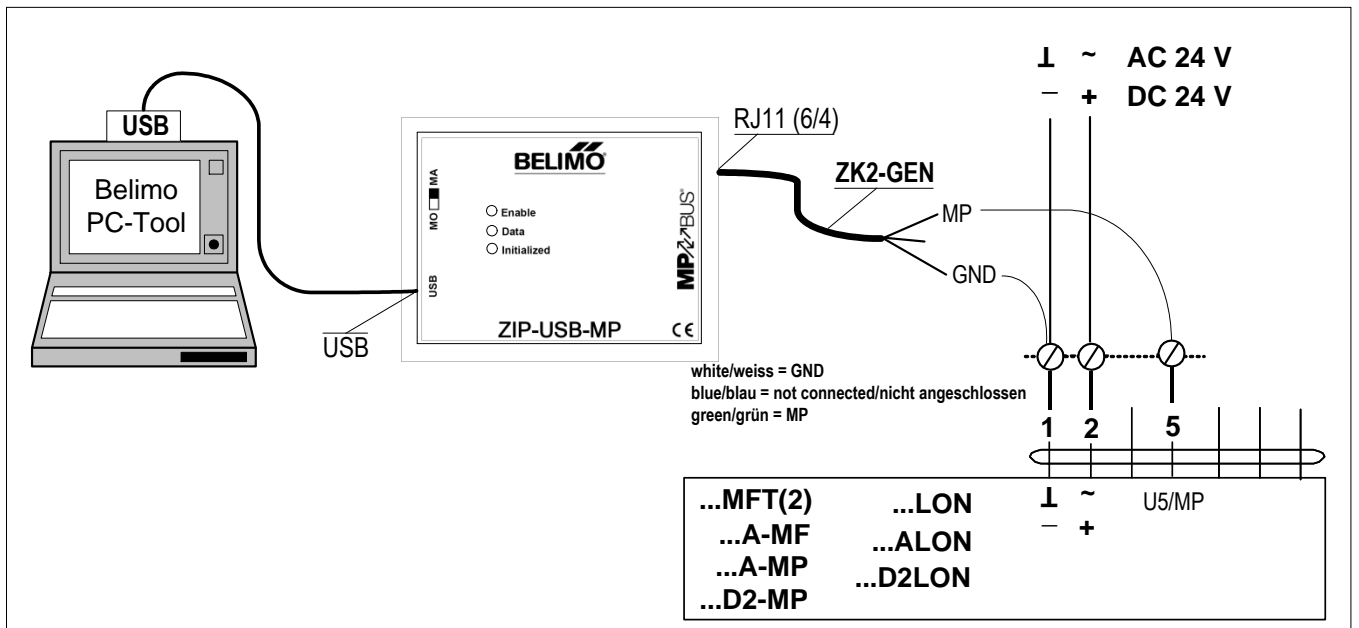

Typical wiring diagram 3

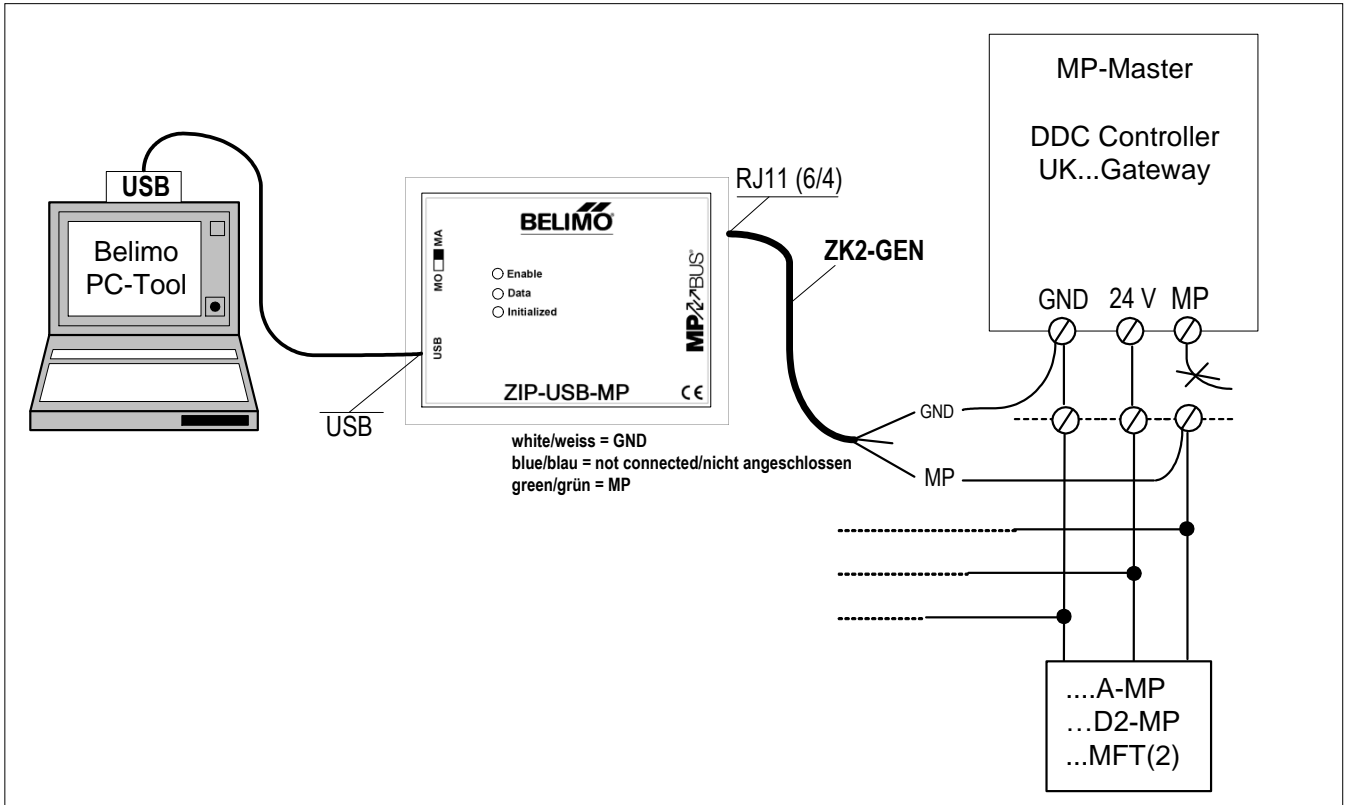

Typical wiring diagram 4

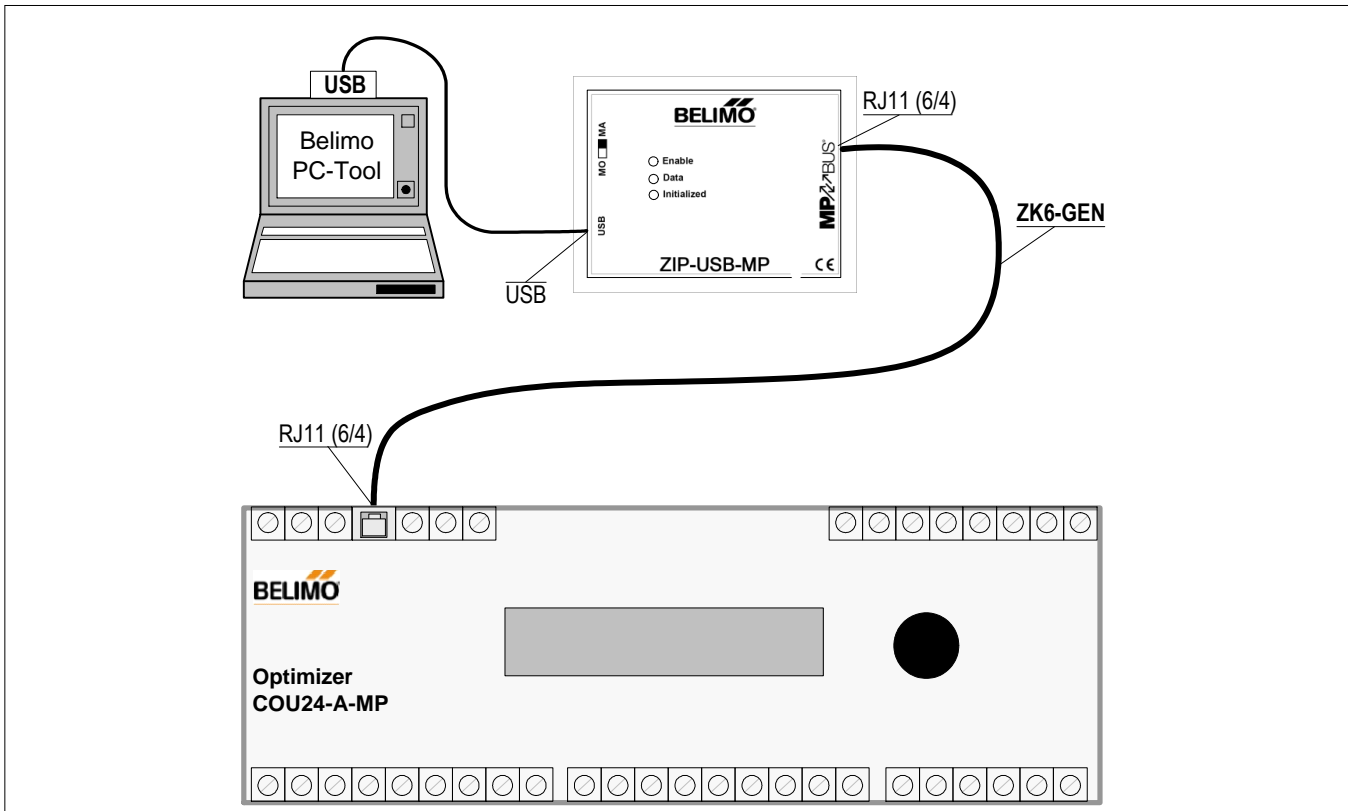

Typical wiring diagram 5

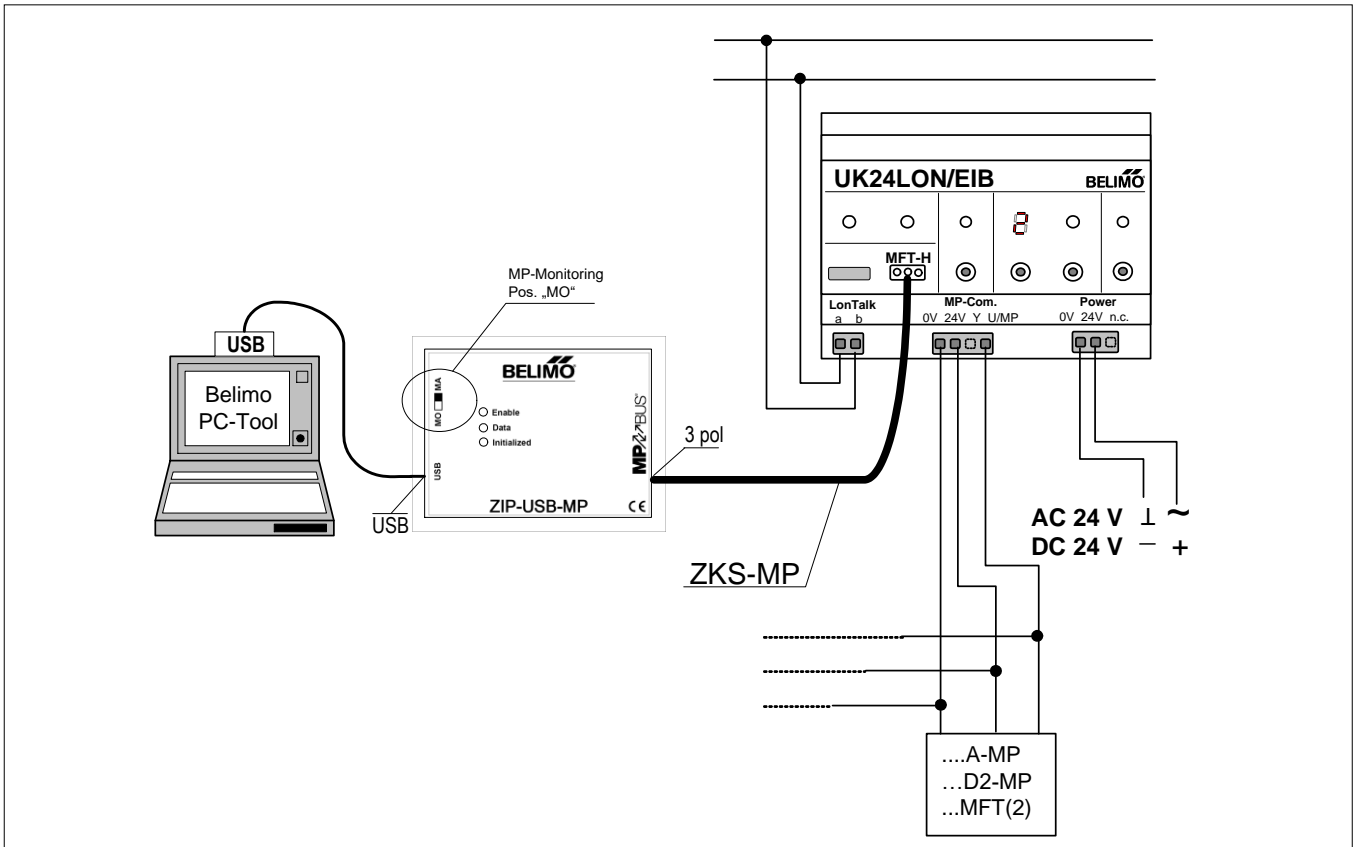

Typical wiring diagram 6

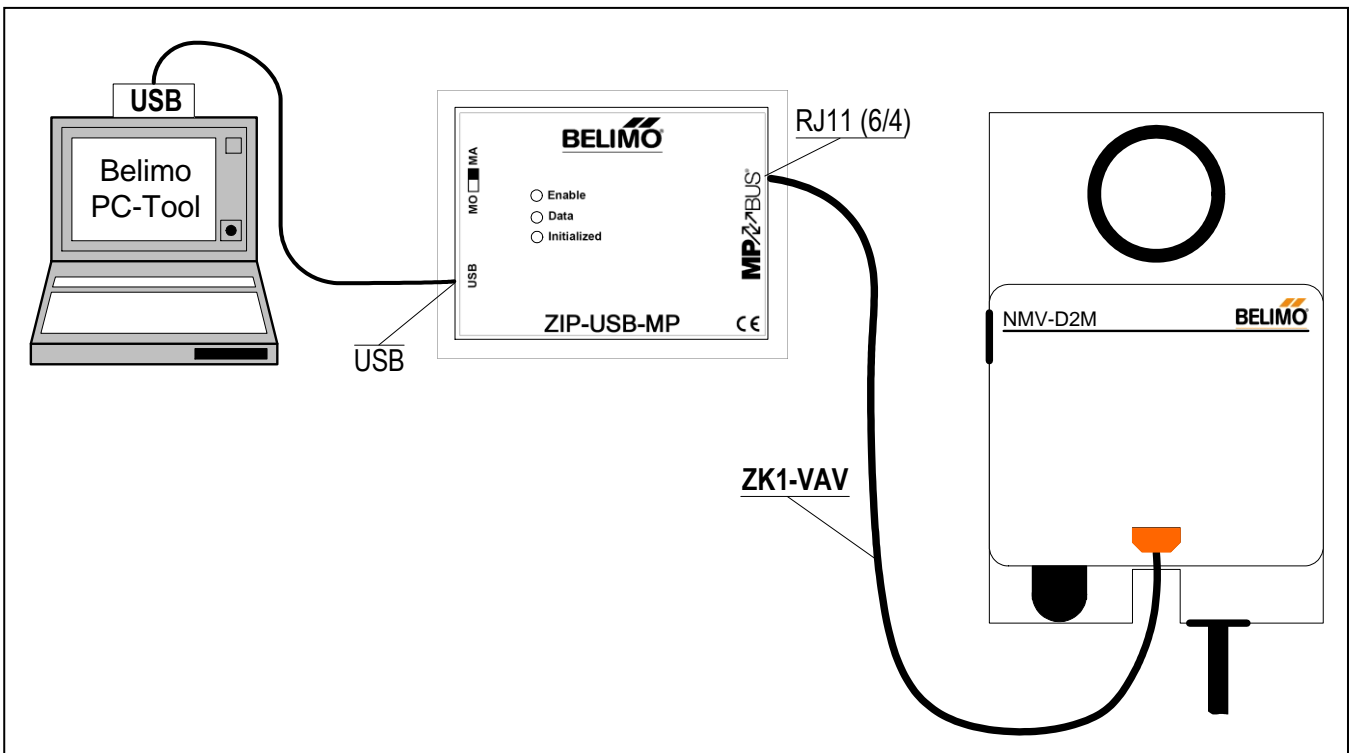

Typical wiring diagram 7

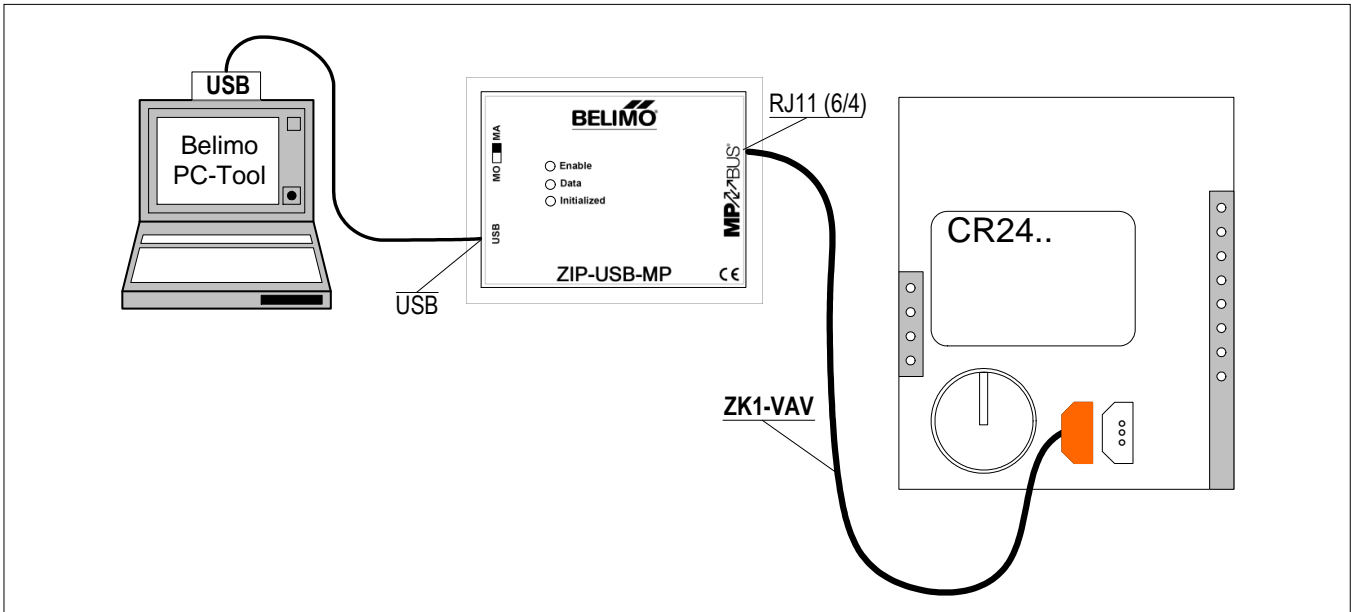

Typical wiring diagram 8

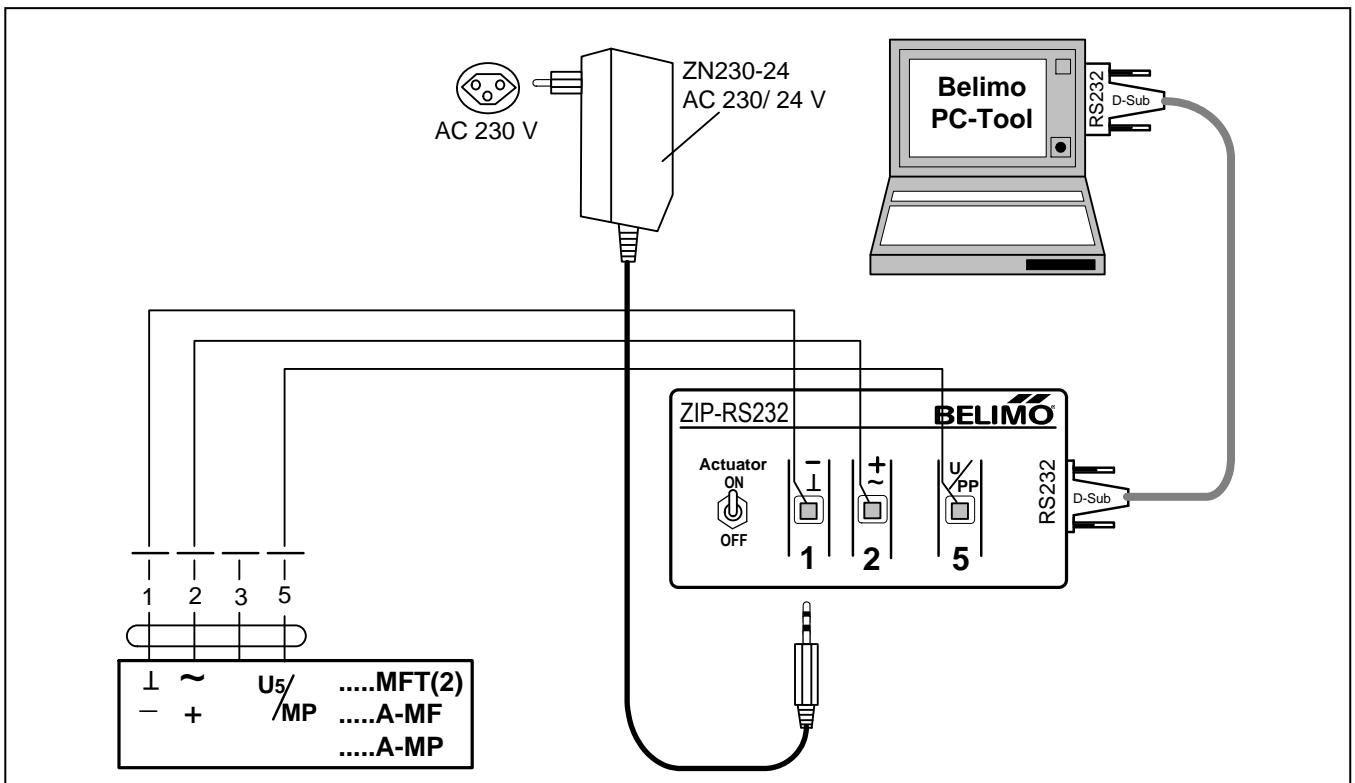



**PC-Tool V3.16 Air module**  
**For damper actuators**  
**User Manual**  
**English**



## Table of Contents

1	Introduction.....	3
2	Service .....	4
2.1	Displaying settings .....	4
2.2	Adaptation .....	7
2.3	Synchronization.....	7
2.4	Function test.....	8
3	Configuration .....	10
4	Controller simulation .....	18
4.1	Actuator control .....	18
4.2	Test .....	20
4.3	Reading out sensors and switches .....	20
4.4	Trend recording .....	22
5	PC-Tool options.....	24

## 1 Introduction

The "Air module" user manual describes the detail area [D] of the Air module. The documentation is divided according to the three index tabs "Service", "Configuration" and "Simulation".

## 2 Service

### 2.1 Displaying settings

The Service tab gives an overview of the current settings of the actuator.

Type **LM24A-MP**  
Designation  
Position

SN **00826-40170-142-130**  
Address **MP6**

**Service**

Configuration

Simulation

**Actual settings**

---

**Control function Y** DC 2-10 V  
**Sensitivity** normal

**Nominal range** 95°                      adapted  
**Running time** 150s

**Angle of rotation** Max: 100% [95°]                      Mid.: 50% [47°]  
Min: 0% [0°]

**Direction of rotation** ccw                      Y= 100%

**Synchronization at** Y=0%

**Torque** 100%

**Bus fail position** Last value  
**Power ON** No action  
**Manual button [once]** Synchronization

---

**Actuator information**

**Firmware** 01 V01.30-0003  
**Config table ID** 0x106D

---

**Data log**

**Operating time** 0h  
**Active time** 0h  
**Stop & Go ratio** 0%

---

**Messages**

**Messages** Reset Messages

Test

Adaption

Synchronization

Service tab for full-rotation damper actuators

For linear actuators the stroke is displayed instead of the angle of rotation, and the torque instead of the positioning force.

**Nominal range** 100 mm                      adapted  
**Running time** 150s

**Stroke** Max: 100% [100mm]                      Mid.: 50% [50mm]  
Min: 0% [0mm]

**Direction of stroke** up                      Y= 100%

**Synchronization at** Y=0%

**Force** 100%

*Service tab for linear actuators (excpert)*

Meaning of the settings

Control signal Y	Type of control
Sensitivity	Response sensitivity and reversal hysteresis of the control function
Feedback U5	Type of feedback signal
Range	Position range within the mechanical limits
Running time	related to operating range or a fixed angle/stroke of 95°/100mm (with annotation)
Angle of rotation	Programmed rotation range: Min / Mid / Max (for full-rotation actuators)
Stroke	Programmed stroke range: Min / Mid / Max (for linear actuators)
Direction of rotation	Clockwise/counterclockwise (for full-rotation actuators)
Direction of stroke	Up / down (for linear actuators)
Synchronization at	Stop position 0 % or 100 %
Torque	In percent of the maximum torque (for full-rotation actuators)
Actuating force	In percent of maximum positioning force (for linear actuators)
Piggy back device	Status Piggy back active / inactive
Power fail-/Power off Pos.	Actuator position in case of power fail (exists only on actuators with Electronic Fail Safe modules)
Power Fail Delay	Time delay until actuator drives to power fail position. (exists only on actuators with Electronic Fail Safe modules)
Power Fail Count	Number of power Fail counts (exists only on actuators with Electronic Fail Safe modules)
Manual button [once]	Function when pressed once
Manual button [twice]	Function when pressed twice (not present in "New Generation" actuators)
Function table	Assignment of override setting and override function (only for certain actuators)
Firmware	Software version on the actuator
Config table ID	Identification of the configuration table
Operating time	Number of hours during which the actuator was connected to the power supply
Active time	Number of hours during which the actuator was mechanically in motion and connected to the power supply
Stop & Go ratio	Ratio of active time/operating time in percent. A high Stop & Go ratio indicates an unstable control.

---

Running time, range, direction of rotation and stroke are not displayed on certain actuators.

---

## 2.2 Adaptation

In the adaptation, the actuator determines the range 0% ... 100% by approaching the mechanical limits.

Click the "Adaptation" button on the Service tab.

**Variant** You can also trigger the adaptation directly on the actuator. The necessary buttons for this can be programmed. For example, "Manual button [twice]" can be assigned the adaptation function.

The progress of the adaptation is displayed in the status line. The actuator first moves against the programmed direction to the zero stop and then to the end stop at the full angle of rotation.

Next, the absolute values for a programmed limited angle of rotation range (minimum, mid-position, and maximum) as well as the feedback signal U5 are recalculated and displayed.

---

The adaptation can be blocked in certain actuators.

---

## 2.3 Synchronization

In the case of synchronization, a mechanical limit is moved to in order to determine the absolute range.

For each actuator, it is possible to program whether synchronization will take place at the zero stop (0%) or at the full angle of rotation/stroke (100%).

Click the "Synchronization" button on the Service tab.

**Variant** You can also trigger the synchronization directly on the actuator. The necessary buttons for this can be programmed. For example, "Manual button [once]" can be assigned the synchronization function.

The progress of the synchronization is displayed in the status line. With the setting Synchronization at: Y=0%, the actuator moves against the programmed direction to the zero stop, and with the setting Synchronization at: Y=100% to the end stop at the full angle of rotation/stroke.

---

The synchronization can be blocked in certain actuators.

---

## 2.4 Function test

The function test checks for opening and closing.

First of all, the drive moves to the mechanical stop according to the synchronization position. If the angle of rotation (or stroke) is set to "adapted", movement takes place to the other stop; with "programmed", on the other hand, to the programmed range limit.

Click the "Test" button on the Service tab. The standard display is covered by the test window.

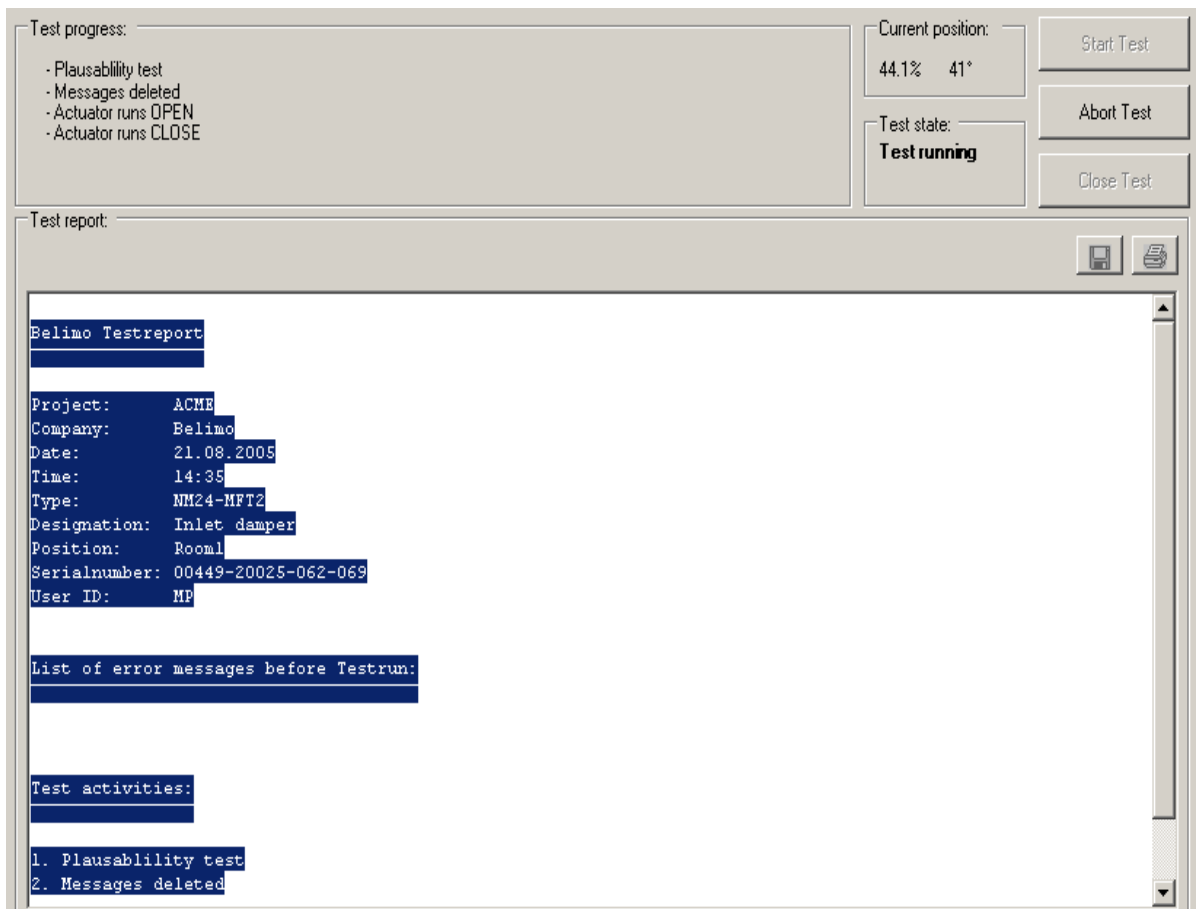

*Display of test progress and test report*

Click the "Start Test" button.

The progress and the current position are continuously displayed.

The test report contains

- information on the project,
- the identification of the actuator,
- a list of fault messages pending before the start of the test,
- the test steps and the test results, and
- the current actuator settings.

---

If the test reports an invalid actuator configuration, go to the "Configuration" tab after ending the test. The values that are not allowed are marked with a flashing exclamation point.

---



You can save the test report as a file by clicking the floppy disk icon, and you can print it with the printer icon.

End the function test with the "Close Test" button. The program asks whether you want to save an unsaved test report now.

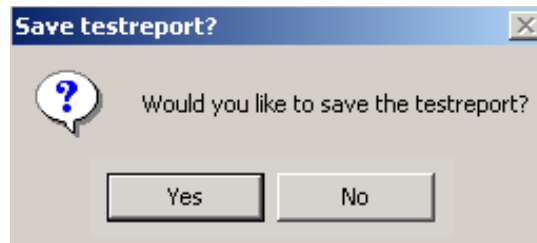

If you cancel the test early, the actuator will be reset to its original state. No test report will be created.

### 3 Configuration

On the "Configuration" tab, you can read out parameter values from the actuator, change them and save them back to the actuator. The valid ranges for the parameter values are displayed in parentheses next to the input boxes.

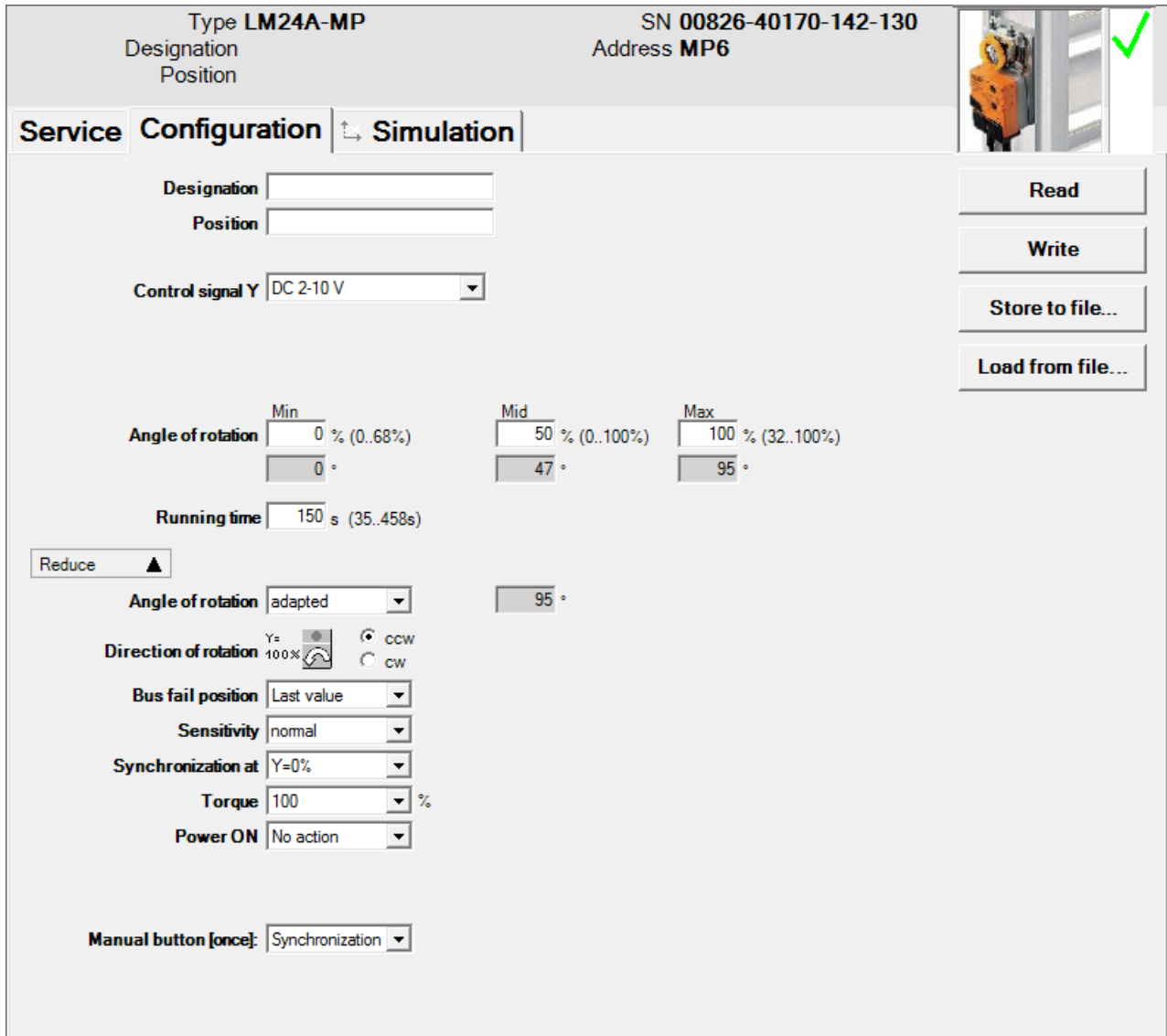

Type **LM24A-MP** SN **00826-40170-142-130**

Designation \_\_\_\_\_ Address **MP6**

Position \_\_\_\_\_

**Service** **Configuration** Simulation

Designation \_\_\_\_\_

Position \_\_\_\_\_

Control signal Y DC 2-10 V

Angle of rotation **Min** 0 % (0..68%) **Mid** 50 % (0..100%) **Max** 100 % (32..100%)

0 ° 47 ° 95 °

Running time 150 s (35..458s)

Reduce ▲

Angle of rotation adapted 95 °

Direction of rotation Y= 100%  ccw  cw

Bus fail position Last value

Sensitivity normal

Synchronization at Y=0%

Torque 100 %

Power ON No action

Manual button [once]: Synchronization

Read

Write

Store to file...

Load from file...

"Configuration" tab for full-rotation damper actuators

---

Note: Running time, range, direction of rotation and stroke cannot be programmed on certain actuators and are therefore not displayed.

---

For linear actuators, the stroke is displayed instead of the angle of rotation and the stroke direction instead of the direction of rotation.

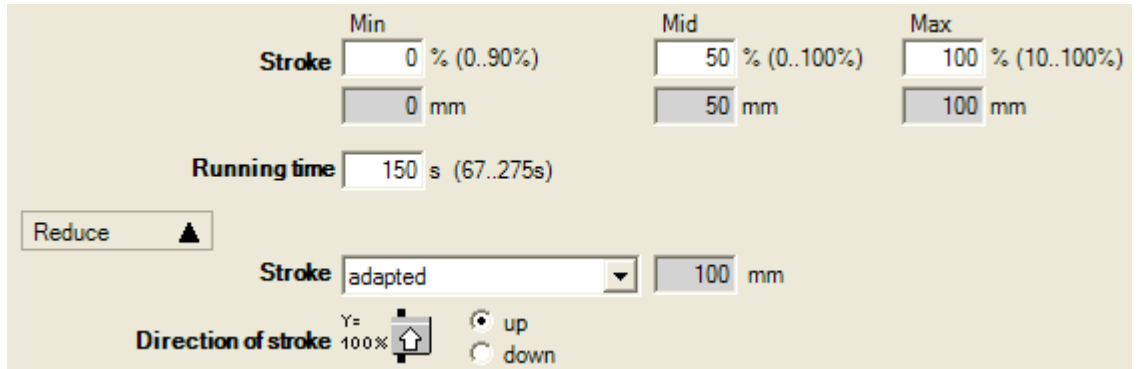

"Configuration" tab for linear actuators (excerpt)

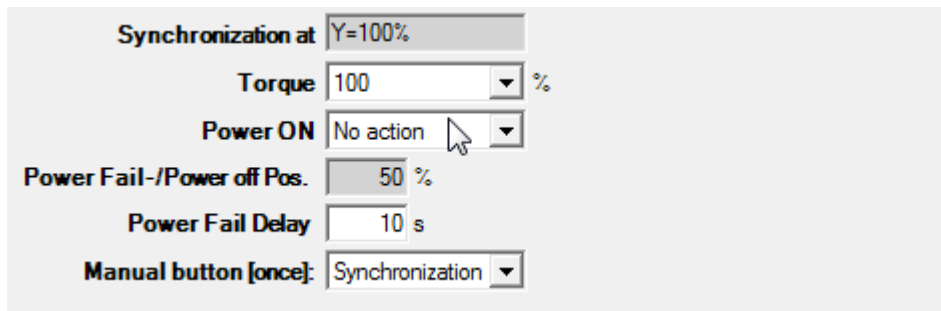

"Configuration" tab for Electronic Fail Safe (excerpt)

Actuator number<sup>1</sup>

Description	16 characters of any text
Position	16 characters of any text

Control signal Y

3-point	AC voltage, positions: Open / neutral / closed
Open / closed	DC or AC voltage, 2-point
DC 0–10 V	(DC voltage) Fixed operating range DC 0–10 V
DC 2–10 V modulating	(DC voltage) Fixed operating range DC 2–10 V

<sup>1</sup> Only characters from the Western European character set are permitted for Description and Position (see General part, table in Section 4.3.3).

DC variable	Start (Y=0%) 0.5 ... 30 V Stop (Y=100%) 2.5 ... 32 V Range between start and stop at least 2 V
PWM 0.02–5 s	Duration of the control pulse (pulse width modulation), fixed operating range
PWM 0.1–25.5 s	Duration of the control pulse, fixed operating range
PWM 0.59–2.93 s	Duration of the control pulse, fixed operating range
PWM variable	Start (Y=0%) minimum 0.02 seconds Stop (Y=100%) maximum 50 seconds
VAV 4 +/- 6 V	When this function is selected, the actuator is parameterized as a VAV actuator and can therefore be controlled by the VAV controllers VR..  Note: When VAV (6 ± 4 V) is selected, the values for minimum, maximum, intermediate value, running time and angle of rotation/stroke are reset to the default values.
4–20 mA	(Direct current) Fixed operating range DC 4–20 mA  Note: This selection is only available for certain drives (e.g. "SunYeh")
mA variable	(Direct current) The values for start and stop are specified in the actuator and cannot be changed with the PC-Tool.  Note: This selection is only available for certain drives (e.g. "SunYeh")

Feedback U5 (only active when the actuator address is set to PP)

Damper position, 2–10 V	DC voltage measurement signal, fixed range
Damper position, 0.5–10 V	DC voltage measurement signal, fixed range
Damper position, variable	DC voltage measurement signal Start 0.5...8.0 V / Stop 2.5 ... 10.0 V Range between start and stop at least 2 V
Damper position, 4–20 mA	Direct current measurement signal, fixed range
...	<i>Certain actuators can define further feedbacks, which you cannot change, however.</i>

U5 scaling (only with "New Generation" actuator, MF or MP types)

Start	Position in percent, corresponds to the start value of the feedback signal
Stop	Position in percent which corresponds to the stop value of the feedback signal

Angle of rotation (for full-rotation actuators)

Stroke (for linear actuators)

Min	Programmed lower limit of the range
Mid	Mid-position of range
Max	Programmed lower limit of the range

An existing value for Mid is automatically adapted when Min and Max are entered: If you enter Min, Mid is always larger than or equal to this input value. If you enter Max on the other hand, Mid is always less than or equal to this value.

Examples of settings for control signal Y / feedback U5

**Control signal Y:** 3...8 V min: 30%, max : 70%  
**Feedback U5 :** 2...7 V start: 20%, stop: 90%

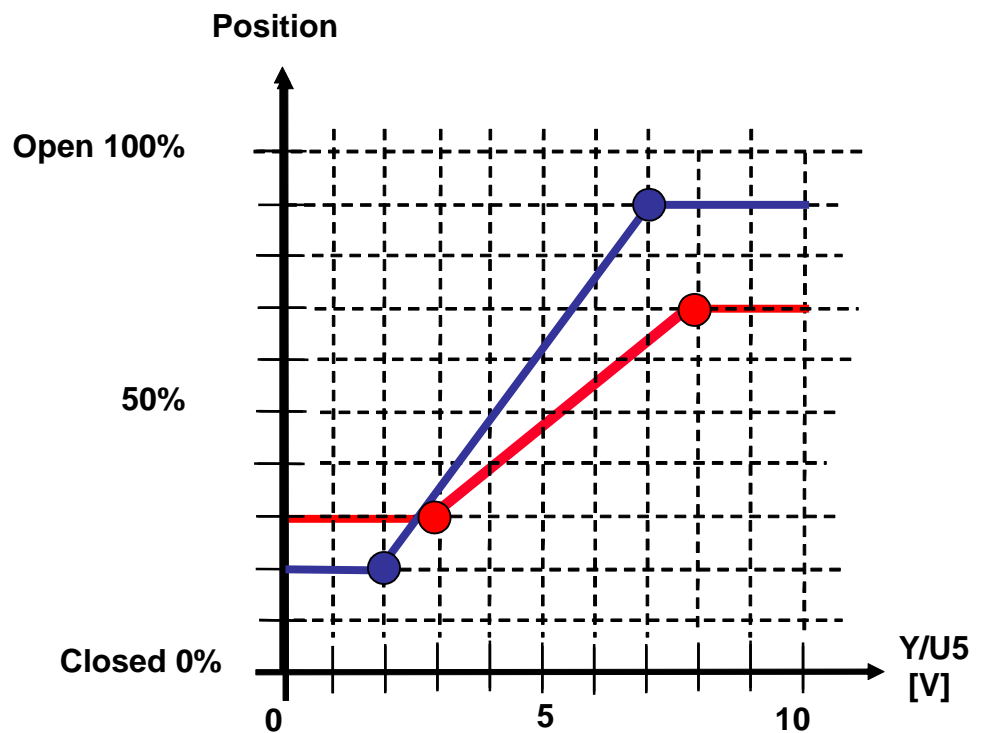

Running time

In seconds	Time needed to pass through the range limited by Min and Max (the valid range of values for the running time depends on the actuator type and the passed-through range).
------------	--

Note: For actuators with the "constant speed" operating mode, the speed does not depend on the range passed through. The running time refers to a fixed angle of 95° for rotary actuators or a fixed stroke of 100 mm for linear actuators.

Angle of rotation (for full-rotation actuators) / Stroke (for linear actuators)

Adapted	from the mechanical limits of certain angle of rotation range/stroke
Programmed	Angle of rotation range (full-rotation) or stroke (linear), the valid values depend on the maximum nominal setting range of the actuator

Direction of rotation (for full-rotation actuators)

cw	Damper opening in the clockwise direction
ccw	Damper opening in counterclockwise direction

Stroke direction (for linear actuators)

open	Upward-opening damper (relative to the orientation of the lettering on the actuator)
down	Downward-opening damper

Power Fail-/Power off Position (only with Electronic Fail Safe module)

in %	emergency Position at Power Fail (can only be changed when poti is in "Tool" position)
------	--

Power Fail Delay (only with Electronic Fail Safe module)

in seconds	time delay until actuator drives to emergency position in power fail case.
------------	--

Behavior in the event of bus failure

Last setpoint	Position according to control signal Y
Open	Move to full angle of rotation/stroke (100 %)
Close	Move to zero stop
Close quickly	Close with maximum speed
Mid / V'mid	Move to Mid position

Sensitivity

Sensitivity	Actuators without spring-return: NM24-MFT(2) AM24-MFT(2) GM24-MFT(2)	Actuators with spring return: LF24-MFT(2) AF24-MFT(2)	Actuators of the new generation and linear: ..MF ..MP ..LON
Normal			
– Response sensitivity:	1° angle of rotation	1° angle of rotation	1% @ operating range (SY → 2%)
– Reversal hysteresis	2.5° angle of rotation	2.5° angle of rotation	2.5% @ operating range (SY → 3%)
Reduced			
– Response sensitivity:	2° angle of rotation	2° angle of rotation	2% @ operating range (SY → 5%)
– Reversal hysteresis	5° angle of rotation	5° angle of rotation	5% @ operating range (SY → 6%)

Synchronization at

Y = 0%	Moves to the mechanical limit at zero stop (depending on the direction of rotation / stroke direction)
Y = 100%	Moves to the mechanical limit at full angle of rotation (depending on direction of rotation / stroke direction)

---

Note: When the nominal setting range is set to "programmed", then the synchronization MUST be carried out at Y=0%.

---

Torque (for full-rotation actuators) / Positioning force (for linear actuators)

25% ... 100%	Can be set in increments of 25%. 100% corresponds to the maximum torque / the maximum positioning force for the actuator type (see nameplate)
--------------	---

Power ON

Synchronization	Moves to a mechanical limit (according to the setting "Synchronization at")
Adaptation	Moves to both mechanical limits and recalculates angle-dependent parameters
Nothing	(This option is not available for actuators of the "TOP" performance class. When switched on, they must always be adapted or synchronized)

You can programmatically limit the rotation and stroke range at one end by only changing the minimum or the maximum. If the value of Power ON is set to "Nothing", then the following holds true:

*The mechanical limit that can still be attained within a rotation range limited at one end will be used for synchronization.*

If you set the minimum to a value greater than 0%, the zero stop will no longer be in the range. In this case, synchronization will take place at the end stop of the full damper opening (Y = 100%). If, on the other hand, you set the maximum to a value smaller than 100%, synchronization will take place at the zero stop (Y = 0%).

This is also valid for the case that the nominal setting range is set to "programmed" and the minimum is equal to 0%: The setting "Power ON: Nothing" is allowed.

Synchronization when the angle of rotation/stroke is limited at both ends

If the minimum is greater than 0% AND the maximum is smaller than 100%, then you can select where the synchronization will take place. In this case, it is necessary to perform synchronization or adaptation when you switch the device on (the setting "Power ON: Nothing" is considered an error).

If the nominal setting range is set to "programmed" and the minimum is greater than 0%, then the same rule applies: At least one synchronization must be programmed.



Manual button [once]/[twice]

Synchronization	Moves to a mechanical limit (according to the setting "Synchronization at") when the manual button is pressed once or twice respectively
Adaptation	Moves to both mechanical limits and recalculates angle-dependent parameters when the manual button is pressed once or twice respectively

---

Note: For "New Generation" actuators (types MF, MP), the function Manual button [twice] is not available.

---

**Only in case of a SY- actuators:** Function table for behavior when Y-control signal is missing

	Condition Y	Reaction
No Y-signal: No fct	Cable disc.	None
	Earthing (GND)	CLOSED
No Y-signal: OPEN	Cable disc.	OPEN
	Earthing (GND)	OPEN
No Y-signal: CLOSED	Cable disc.	CLOSED
	Earthing (GND)	CLOSED
No Y-signal: STOP	Cable disc.	STOP
	Earthing (GND)	STOP

---

Activate the "Show function table" checkbox in order to show the function table. For addressed MP actuators only "No fct" is possible.

---

## 4 Controller simulation

Go to the "Simulation" tab.

Simulation tab for damper actuators

---

The controller simulation is not possible while the actuator is performing an adaptation or synchronization.

---

### 4.1 Actuator control

Select the type of setpoint definition with the radio buttons.

- Setpoint Y (only available in PP mode): Control signal at connection Y according to selected control type (DC, PWM, open/close, 3-point).

Setpoint Tool (not available with control type open/close or 3-point): The setpoint is entered in % of the programmed range. 0% is the minimum, 100% the maximum. The input values are converted and displayed in the units of the corresponding control signal (volts, milliamps or seconds).

The control is switched off when you click "Motor stop". This function is not available with the control types open/close and 3-point.

#### Measurement values

During the simulation, the current angle of rotation or stroke is displayed in % of the absolute (mechanically limited) range and – converted according to the scale setting – as a feedback value in volts or milliamps.

## 4.2 Test

The test function is available for the structured testing of the Air actuator.

A number of commands which follow one another in sequence are defined in a test script file. A trend record is triggered at the start of the function.

#### Select test file

At the moment there aren't any predefined test scripts available. Custom test scripts can be produced any time and be selected through the Combobox.

Select the desired script with the Combobox test file. Only test scripts for Air modules are displayed in the Combobox.

#### Start test script

Click on the test ▶ button. The tests will begin at once.

#### Create test script

In accordance with the templates, users can also create test scripts of their own. File name must contain the character block "Air".

## 4.3 Reading out sensors and switches

The values of sensors and switches can be read out in MP mode. This function, however, must be activated in advance in the PC-Tool options under "General". Select Tools ▶ Options in the main menu.

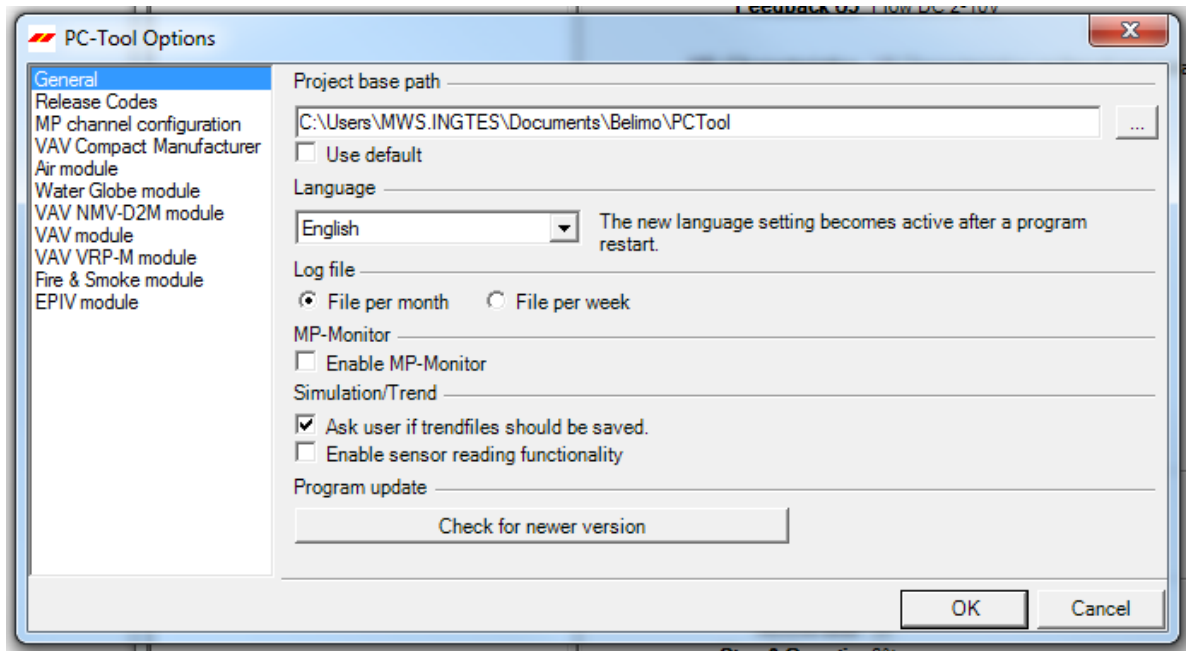

*Settings for reading out sensors*

On the Simulation tab, a section with the sensor values is displayed to the right of the actuator control.

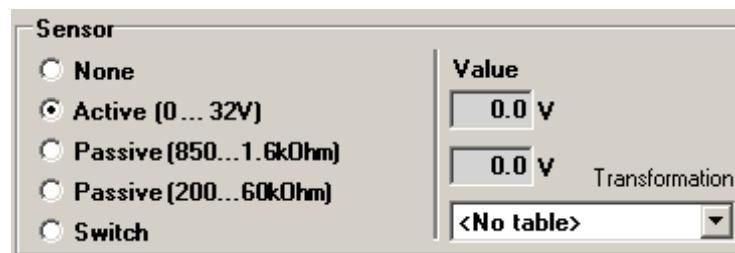

*Sensor display in MP mode*

Select the type of the connected sensor with the radio buttons. The value is either displayed in volts (active), ohms (passive) or as on/off (switch).

The transformation table allows you to additionally convert the raw value of the sensor into the corresponding measuring quantity (temperature etc.). (See the "Transformation table" section in the General User Manual)

### 4.4 Trend recording

During simulation, the time progress of the setpoints and actual values can be displayed in a plot. The values are saved in a trend file and can be displayed again at a later time. Furthermore, you can add any comment texts you would like.



On trend record, the trend is automatically saved to a temporary file and retained for one month. Click on the icon "Save" to save the trend with a different name and location (after stop record).

In the PC tool options "General" specify whether the program should ask for the new file name (ask user if trend files should be saved). The suggested file name can be modified before saving the file.

Click the "Trend Record" button during simulation. The display changes to a "flat" button. The recording stops when you click again.

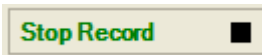

The Trend View radio buttons allow you to set whether the display is given in percent of the full range (%) or in volts (V).

The position is queried every second by default. You can change the query interval in an input box. The permitted values are 0 to 9999 seconds, whereby the value 0 means "no waiting time" (query as quickly as possible).

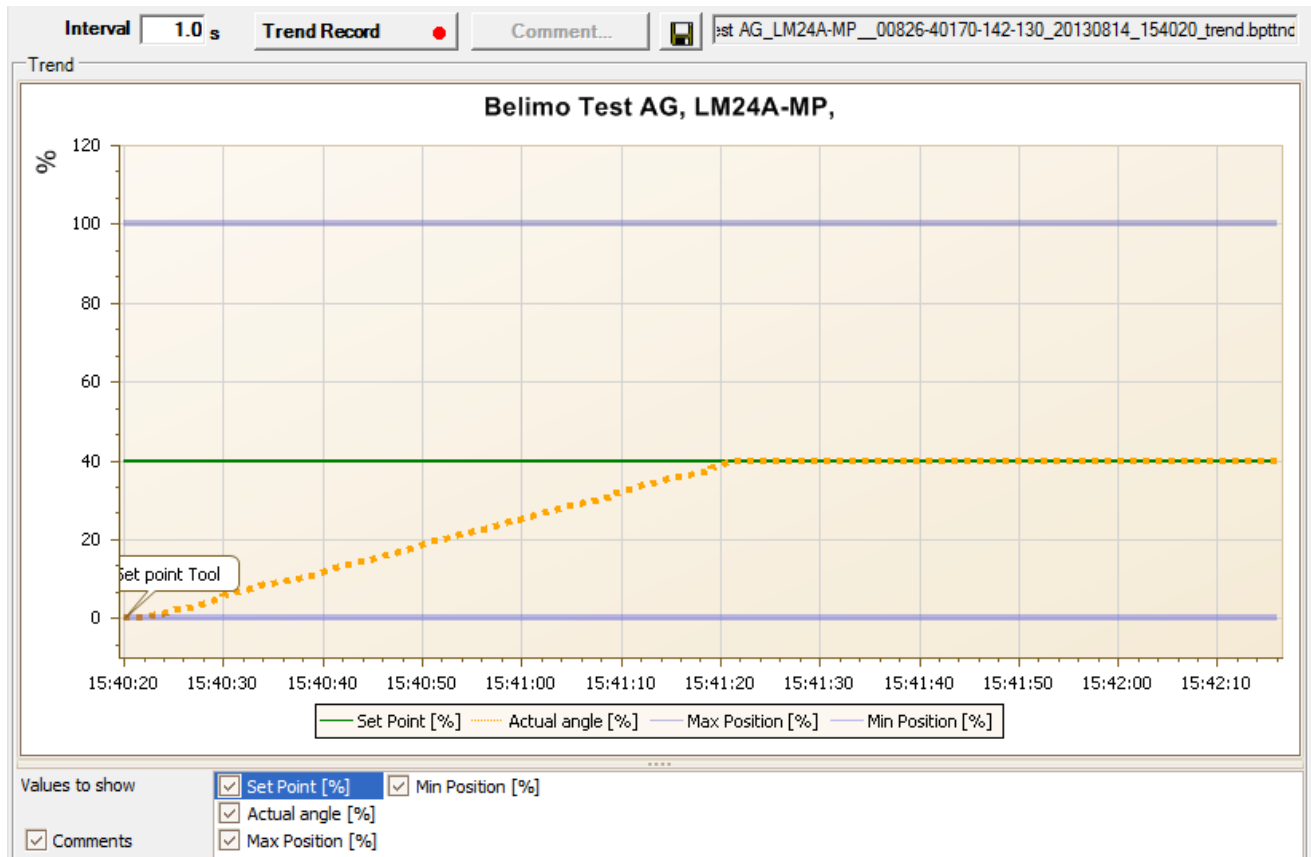

Trend plot

The Comment button allows you to enter a text at a defined time and the text is then saved in the trend file.

---

If you want to record a trend for more than one hour (long-term trend), enter a value of at least 2 seconds for the interval. If the interval is shorter, too many data points will result and the time for correcting the curve between the queries can become too short.

---

## 5 PC-Tool options

Select Tools ► Options in the main menu.

Variant Click the right mouse button on the program icon in the outline bar and select "Options".

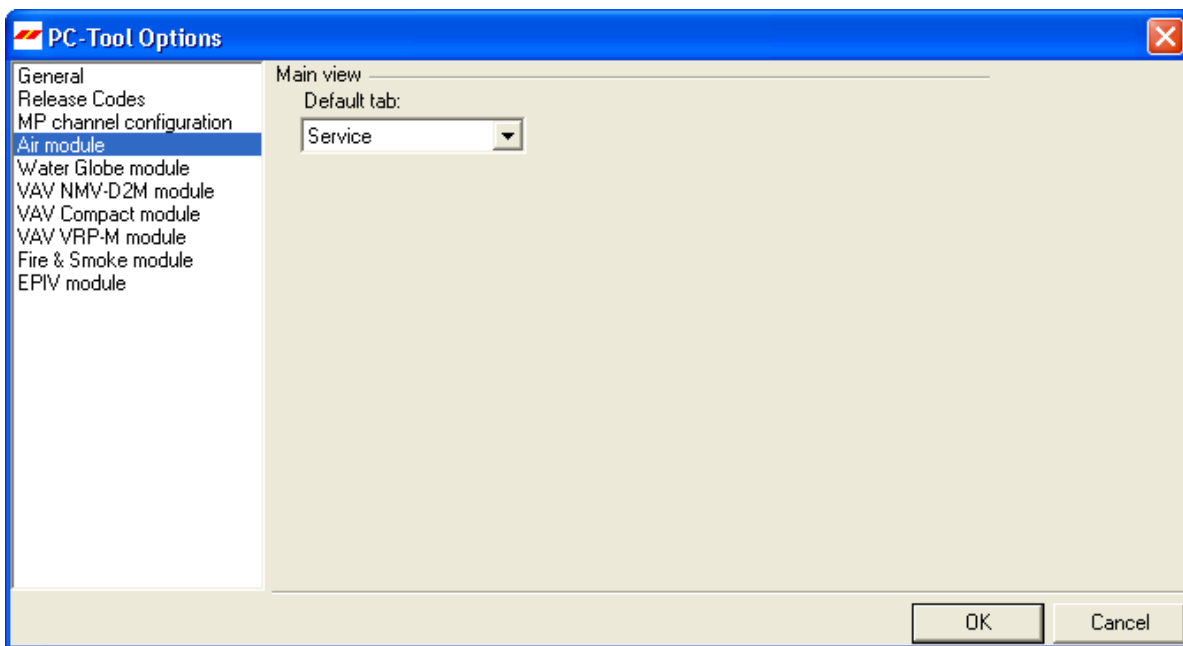

*Dialog for basic settings (Air module)*

Select "Air module" on the left.

Using the combo box "Default tab", you can select the index tab you want to open by default when starting the program PC-Tool.



**PC-Tool V3.16 Fire & Smoke module**  
**For fire damper actuators**  
**User Manual**  
**English**



# Table of Contents

1	Introduction.....	3
2	Service .....	4
2.1	Displaying settings .....	4
2.2	Damper free running test.....	5
2.3	Adaptation .....	5
2.4	Function test.....	6
2.5	Deleting maintenance/error messages .....	7
3	Configuration .....	8
3.1	Basic configuration .....	8
3.2	Advanced configuration (manufacturer view) .....	9
3.2.1	Settings .....	9
3.2.2	Program.....	10
3.2.3	Parameter file .....	10
3.2.4	Factory programming.....	12
4	Controller simulation .....	14
4.1	Actuator control .....	14
4.2	Self-test.....	15
4.3	Damper free running test.....	15
5	PC-Tool options.....	16
5.1	Basic options.....	16
5.2	Advanced options (manufacturer view).....	17

## 1 Introduction

The "Fire & Smoke module" user manual describes the detail area [D] of the fire & smoke module. The documentation is structured according to the three tabs "Service", "Configuration" and "Simulation".

## 2 Service

### 2.1 Displaying settings

The "Service" tab gives an overview of the current actuator settings.

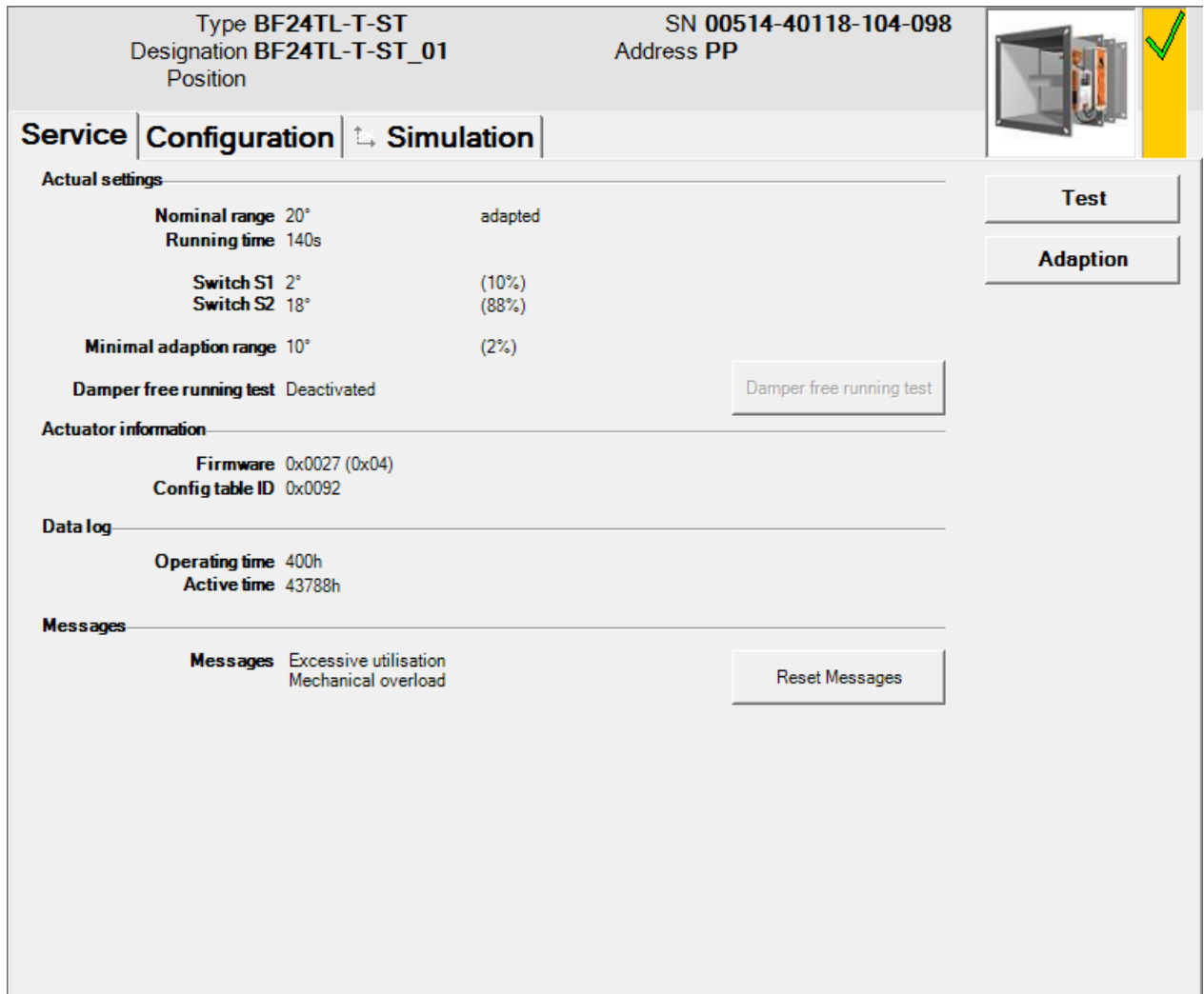

The screenshot displays the 'Service' tab for a BF24TL-T-ST fire damper actuator. At the top, it shows the device type, designation (BF24TL-T-ST\_01), position, serial number (00514-40118-104-098), and address (PP). The interface is divided into several sections:

- Actual settings:** Includes 'Nominal range' (20°), 'Running time' (140s), 'Switch S1' (2°), 'Switch S2' (18°), and 'Minimal adaption range' (10°). A 'Damper free running test' is shown as deactivated with a 'Damper free running test' button.
- Actuator information:** Shows 'Firmware' (0x0027 (0x04)) and 'Config table ID' (0x0092).
- Data log:** Displays 'Operating time' (400h) and 'Active time' (43788h).
- Messages:** Lists 'Excessive utilisation' and 'Mechanical overload' with a 'Reset Messages' button.

On the right side, there is a 'Test' button, an 'Adaption' button, and a small image of the actuator with a green checkmark.

"Service" tab for BF-TopLine fire damper actuators

No settings are displayed for motorization solutions with conventional fire damper actuators and a BKN230-24-1MP gateway. Please refer to the actuator data sheets for more information.

#### Meaning of the settings

Nominal range	Range of rotation within the mechanical end stops
Running time	Time needed to cover the full range of rotation
Switch S1	Switching point for the safety position (in ° and %)

Switch S2	Switching point for the operating position (in ° and %)
Minimal adaption range	Safety limit to prevent adaptations if dampers are blocked (in ° and %)
Damper free running test	Values for the automatic test in the operating position (values for 180° types in parentheses)
Firmware	Software version installed on the actuator
Config table ID	Identifies the configuration table
Operating time	Number of hours for which the actuator was connected to the power supply
Active time	Number of hours for which the actuator was mechanically in motion and connected to the power supply

## 2.2 Damper free running test

The damper free running test checks the actuator's ability to turn from the operating position toward the safety position. Only the configured range is tested, to prevent complete closure of the damper. The test is repeated after 24 hours.

The damper free running test is suitable for all applications in which the ventilation system is not allowed to be switched off in order to carry out a full damper test.

Click the "Damper free running test" button on the "Service" tab to start the test manually.

---

The damper must be in the operating position and the damper free running test must not be deactivated.

---

## 2.3 Adaptation

Adaptation is when the actuator determines the 0% ... 100% range by approaching the mechanical end stops.

Click the "Adaption" button on the "Service" tab.

The progress of the adaptation is displayed in the status bar. The actuator starts by moving into the safety position, then approaches the stop in the operating position. The maximum angle of rotation reached is stored in the actuator.

The absolute values for switching points S1 and S2 are then recalculated.

---

It is important to ensure that the damper blade reaches the mechanical end stops during the adaptation (visual monitoring of the damper).

---

## 2.4 Function test

The function test checks the opening and closing of the actuator.

The actuator starts by moving into the safety position, then approaches the operating position.

Click the "Test" button on the "Service" tab. The standard display is hidden by the test window.

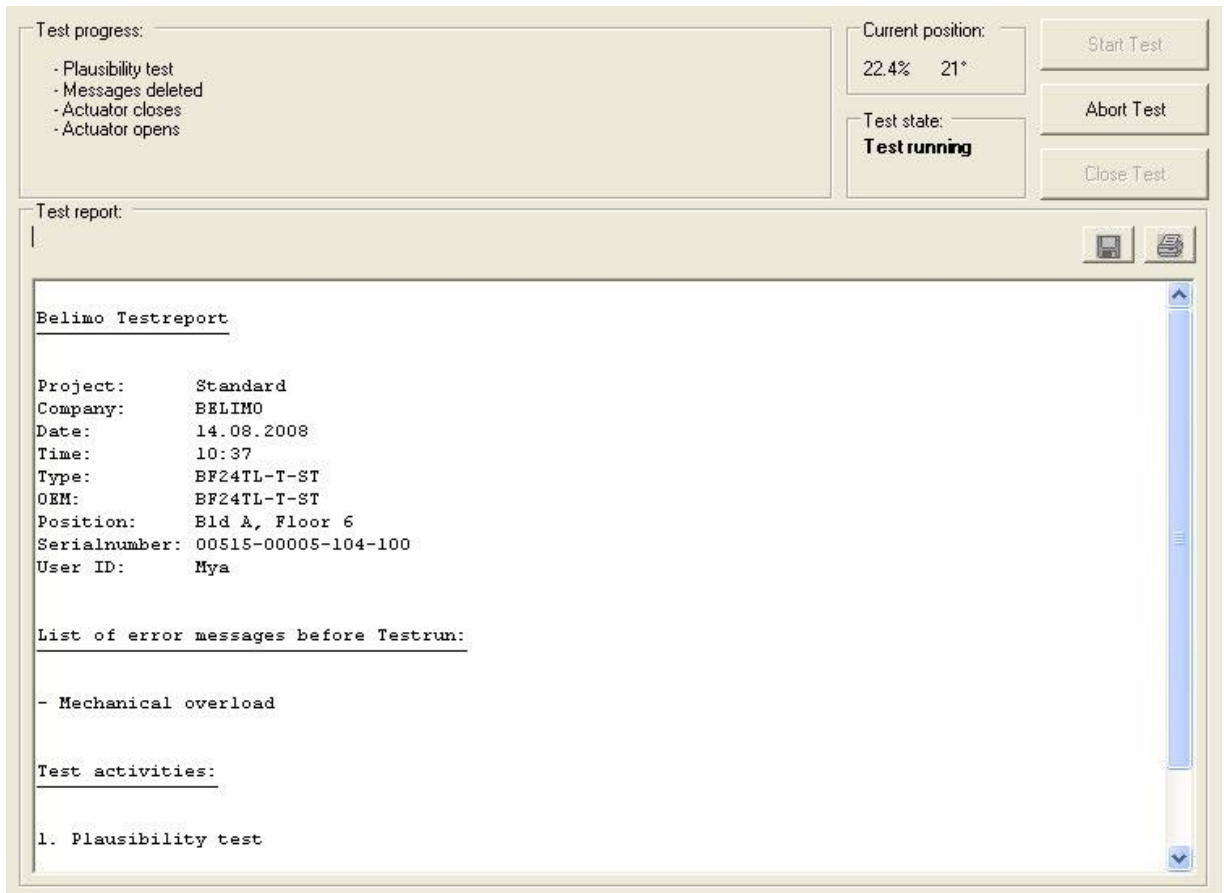

*Test progress and test report display*

Click the "Start test" button.

The progress and the current position are continuously displayed.

The test report contains

- Information on the project,
- the actuator ID,
- a list of error messages pending before the start of the test,
- the test steps and the test result, and
- the current actuator settings.

---

If the test reports an invalid actuator configuration, switch to the "Configuration" tab after ending the test. All values that are not permitted are marked there by a flashing exclamation point.

---

## 2.5 Deleting maintenance/error messages

Any maintenance or error messages that are generated and stored by the actuator are displayed on the "Service" tab.

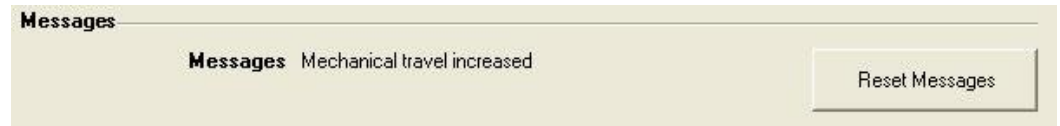

*Message display on the "Service tab"*

Click "Reset messages" to delete all messages stored in the actuator.

The following messages are displayed:

Message	Description
Mechanical travel increased	Expected end stop value for top or bottom has been overrun (adapted range)
Mechanical overload	Actuator did not reach setpoint because an obstacle has reduced the adjustment travel
Excessive utilization	Actuator moves too often compared to the total operating time
Safety relevant fault [ <i>Details</i> ]	Safety relevant fault in the actuator (e.g. ambient temperature too high). Actuator moves into the safety position
Damper test error	Damper free running test revealed an error
Duct temperature too high	Thermoelectrical tripping device has detected a duct temperature that is too high. Actuator moves into the safety position
Smoke detector tripped	Contact for connecting a smoke detector is open. The actuator moves into the safety position.

---

The message "Safety relevant fault" refers to an actuator fault that could interfere with the safety function. This message cannot be deleted. The actuator must be replaced.

---

### 3 Configuration

#### 3.1 Basic configuration

On the "Configuration" tab, you can read the parameter values stored in the actuator, change them, and re-store them in the actuator. The valid ranges for the parameter values are shown in parentheses next to the input fields.

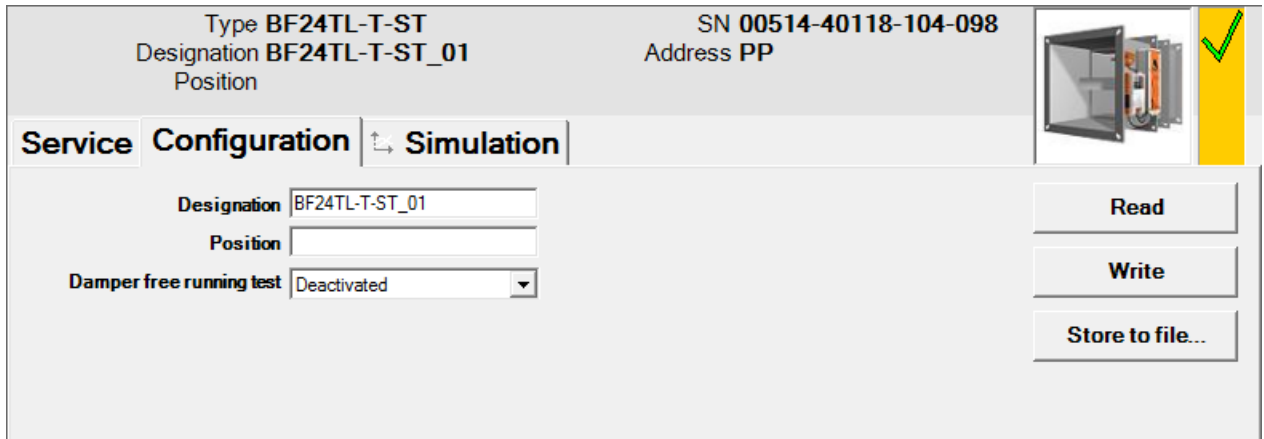

"Configuration" tab

#### Actuator identification<sup>1</sup>

Designation	Any 16 characters
Position	Any 16 characters

#### Damper free running test

Deactivated	Automatic test function deactivated
5°/7 s (10°/7 s)	A damper free running test is carried out every 24 hours with the specified test criteria (range of rotation, time limit). The values shown in parentheses apply to actuators with a 180° angle of rotation.
10°/10 s (20°/10 s)	
20°/20 s (40°/20 s)	

---

The "Damper free running test" setting is not supported by the BKN230-24-1MP gateway.

---

<sup>1</sup> Only characters in the Western European character set are allowed in the designation and location (see General part).



### 3.2 Advanced configuration (manufacturer view)

Additional configuration parameters (protected by a release code) are available for fire damper manufacturers and authorized partners.

#### 3.2.1 Settings

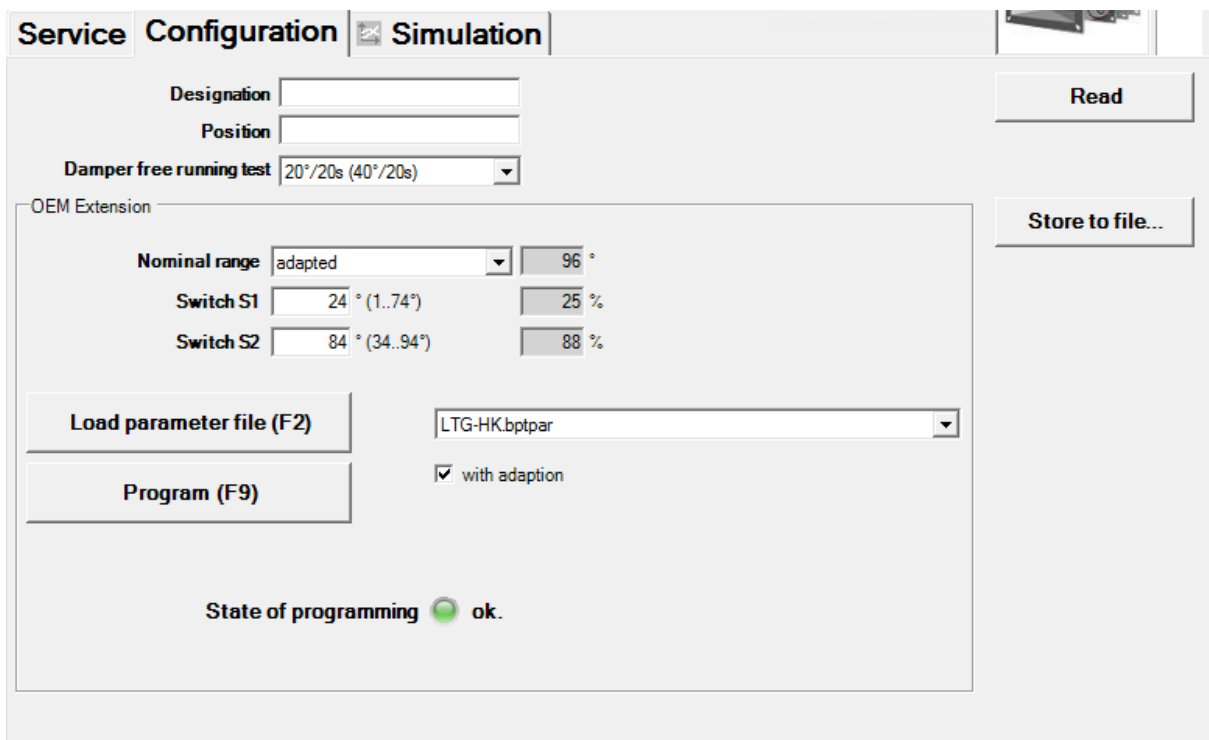

"Configuration" tab with manufacturer view

The following additional settings are possible:

#### Nominal range (rotation angle)

Adapted	Range of rotation is determined by the fire damper's mechanical end stops (adaptation)
Programmed	Rotation angle range can be selected within the limits defined by the maximum nominal setting range

#### Switching points

Switch S1	Switching point for the safety position in degrees (°); this value is stored in the actuator as a percentage (%) and recalculated if the range (angle of rotation) is changed
Switch S2	Switching point for the operating position in degrees (°); this value is stored in the actuator as a percentage (%) and recalculated if the range (angle of rotation) is changed

Click the "Read" button to reload the actuator data.

### 3.2.2 Program

Click the "Program" button to store the new settings in the actuator.

Alternative Alternatively, you can press function key F9.

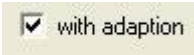

The rotation angle range of the actuator is normally determined by adaptation (Range: Adapted). If the "With adaption" checkbox is selected, the final programming step is to start the adaptation.

If the actuator has already been adapted and you simply want to change a setting, this checkbox can be deselected.

The programming status is indicated by a traffic light (yellow, green, red) and an explanatory text.



Programming sequence:

①	Connect the actuator
②	Set the parameters
③	Press "Program" (F9)
	<i>...Wait until programming has finished (including adaptation)...</i>
④	Check the programming status
⑤	Print labels (optional)
⑥	Remove the actuator

For factory programming, refer to Section 3.2.4

### 3.2.3 Parameter file

The fixed configuration settings for each damper type can be saved to a parameter file to speed up the programming of several actuators.

The respective input fields will have a yellow background when you load these values by clicking the "Load parameter file (F2)" button.

Alternative Alternatively, you can press function key F2.

The individual values (e.g. Position) can be changed before you start programming.

Example:

```

// BELIMO PC-Tool
// Company: Damper Manufacturer XY
// -----
OEMString                ; Product XY      ;
PositionString           ;                ;
MP_Set_Switch            ;      1000;   9000;
MP_Set_Operating_Range   ;          0;
MP_Set_Extended_Functions ;          11;
MinMaxOperatingRange     ;      8800;   9200;
    
```

The easiest way to create a parameter file is to select the required settings in PC-Tool, then save them with "Store to file". The file can be subsequently modified in a text editor program (e.g. Notepad).

Keywords

OEMString	Designation, any 16 characters
PositionString	Position, any 16 characters
MP_Set_Switch	Switching points S1 and S2 in percent with two decimal places (1000 → 10.00%)
MP_Set_Operating_Range	Programmed range (angle of rotation) in degrees with two decimal places (9000 → 90.00°); 0 corresponds to the adapted range
MP_Set_Extended_Functions	Extended functions, possible values: 0: Damper free running test deactivated 11: Damper free running test 5°/7 s (10°/7 s) 26: Damper free running test 10°/10 s (20°/10 s) 42: Damper free running test 20°/20 s (40°/20 s)
MinMaxOperatingRange	Limit values (angle of rotation) after programming (adaptation) in degrees with two decimal places (8800 → 88.00°)  These values are not stored in the actuator but are used by PC-Tool to evaluate the programming status.

---

After defining a parameter file, you should save it with the "Write protected" attribute to prevent it from being inadvertently modified.

---

### 3.2.4 Factory programming

Factory programming is carried out for several dampers, which is why an optimized sequence is recommended.

Preparatory steps (required only once):

- Create a project
- Create parameter files (with overwrite protection)
- Create a configuration file for printing labels
- Set the PC-Tool options
  - MP channel settings: Scan type = "PP only"
  - Fire & Smoke module: Default tab = "Configuration"
  - Fire & Smoke module: Select the parameter file
- Save a shortcut to the project on your desktop

The PC-Tool is opened by double-clicking the project shortcut. The project is opened directly and a bus scan starts immediately. Only one actuator at a time is allowed to be connected to PC-Tool. As soon as PC-Tool detects an actuator, it scans it and automatically opens the "Configuration" tab.

Before programming a batch of dampers please make sure the right parameter file is open and the "With adaption" checkbox is selected correctly.

#### Programming sequence

①	Connect the actuator
②	Click "Load parameter file (F2)"
③	Check the parameters (e.g. Position) and change them if necessary
④	Click "Program (F9)"
	<i>...Wait until programming has finished (including adaptation)...</i>
⑤	Check the programming status
⑥	Print labels (optional)
⑦	Remove the actuator

The adaptation process can take a few minutes. It is therefore best to program a group of actuators in two stages:

- After starting the adaptation, carry out steps 1 to 4 for the other actuators (PC-Tool does not need to be connected in order to finish the adaptation).
- Reconnect all programmed actuators when the adaptation has finished and carry out steps 5 to 7.

---

PC-Tool has no way of knowing whether an actuator is already programmed. You are therefore advised to test the operating range with the narrowest possible limit values (MinMaxOperatingRange, refer to Section 3.2.3).

---

## 4 Controller simulation

Open the "Simulation" tab.

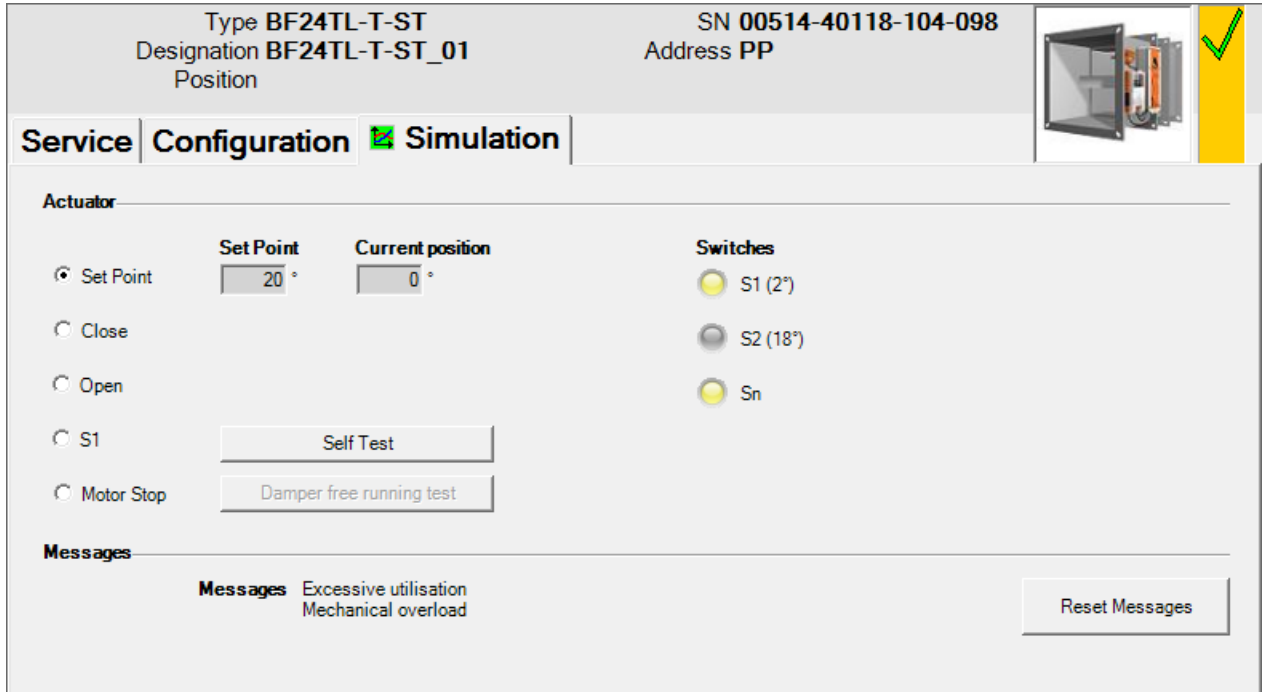

"Simulation" tab

The "Simulation" tab allows you to simulate the controller by selecting predefined setpoints. In addition to the setpoint and the current position, you also see the switch positions.

The actuator's internal self-test and the damper free running test can be run in order to diagnose a fault.

The bottom half of the window shows any messages that are pending. These messages can be reset by clicking the button.

### 4.1 Actuator control

Select the setpoint definition method with the radio buttons.

- Set point: The setpoint is not defined by the program. The last stored actuator setpoint is used.
- CLOSE: The actuator moves into the safety position.
- OPEN: The actuator moves into the operating position.
- S1: The actuator moves to switching point S1, which is used to indicate the safety position.
- Motor stop: The actuator is stopped in the current position.

---

"S1" and "Motor stop" are not supported by the BKN230-24-1MP gateway.

---

#### Current position

In addition to the setpoint, you also see the current position. Both values are shown in degrees (°).

#### Switch position display

The switch positions S1 (safety position) and S2 (operating position) are visualized by means of lamp icons. The switching points for S1 and S2 are configured by the damper manufacturer.

Sn is the mechanical zero position switch for the fire damper actuator and is used to check the end position.

An error message is generated if the actuator is unable to close the zero position switch in the safety position. The actuator remains in the safety position until the end position is indicated by Sn.

---

The zero position switch is not supported by the BKN230-24-1MP gateway.

---

## 4.2 Self-test

The self-test is an internal fire damper actuator test that checks all actuator test functions over the full range of rotation.

In the first test step, all stored messages are deleted. If a safety-relevant fault is still present (e.g. if a duct temperature is too high), it cannot be deleted and will cause the self-test to be canceled.

Click the "Self-test" button to start the test.

---

If the setpoint definition method selected for the actuator is CLOSE, the self-test is stored in the actuator but does not start. The test is not run until you change the setpoint definition to OPEN or S1.

---

## 4.3 Damper free running test

The damper free running test is described in Section 2.2.

Click the "Damper free running test" button to start the test manually. The damper must be in the operating position.

## 5 PC-Tool options

Select Tools ► PC-Tool options in the main menu.

Alternative Click the program icon in the outline bar with the right mouse button and select PC-Tool options.

Select "Fire & Smoke module" from the list on the left.

### 5.1 Basic options

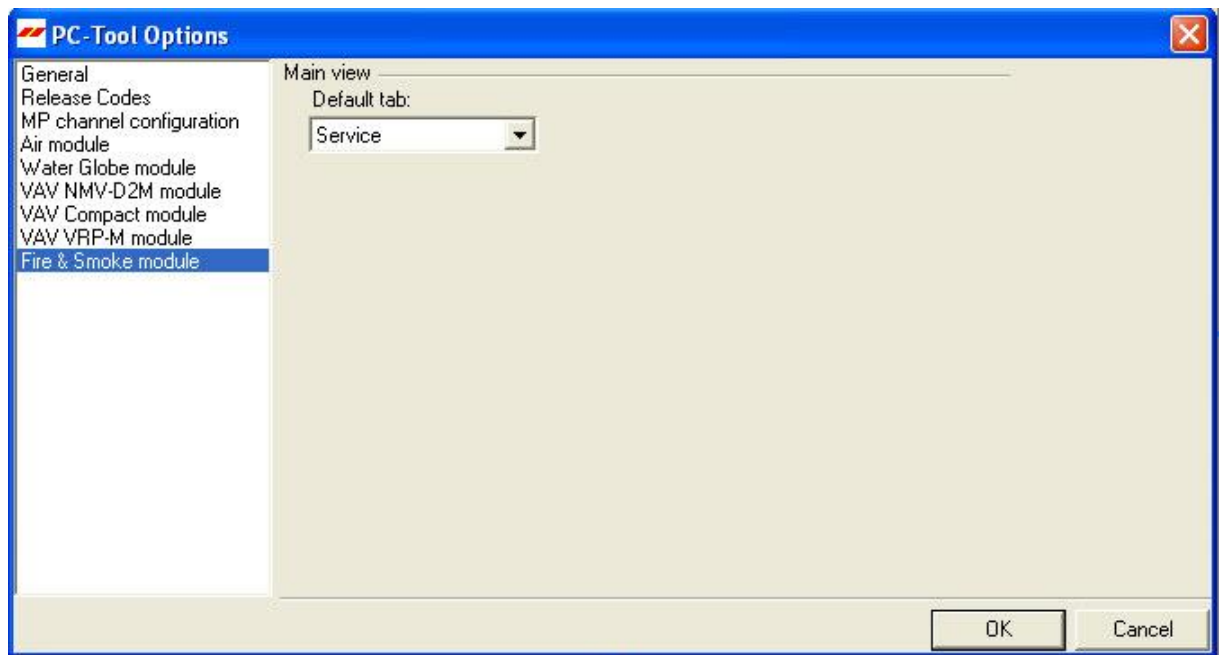

*Dialog for basic settings (fire protection module)*

Depending on the most frequent usage of the program's PC-Tool, use the "Default tab" combobox to select which tab will open by default when the program is started.



## 5.2 Advanced options (manufacturer view)

Additional options (protected by a release code) are available for fire damper manufacturers and authorized partners.

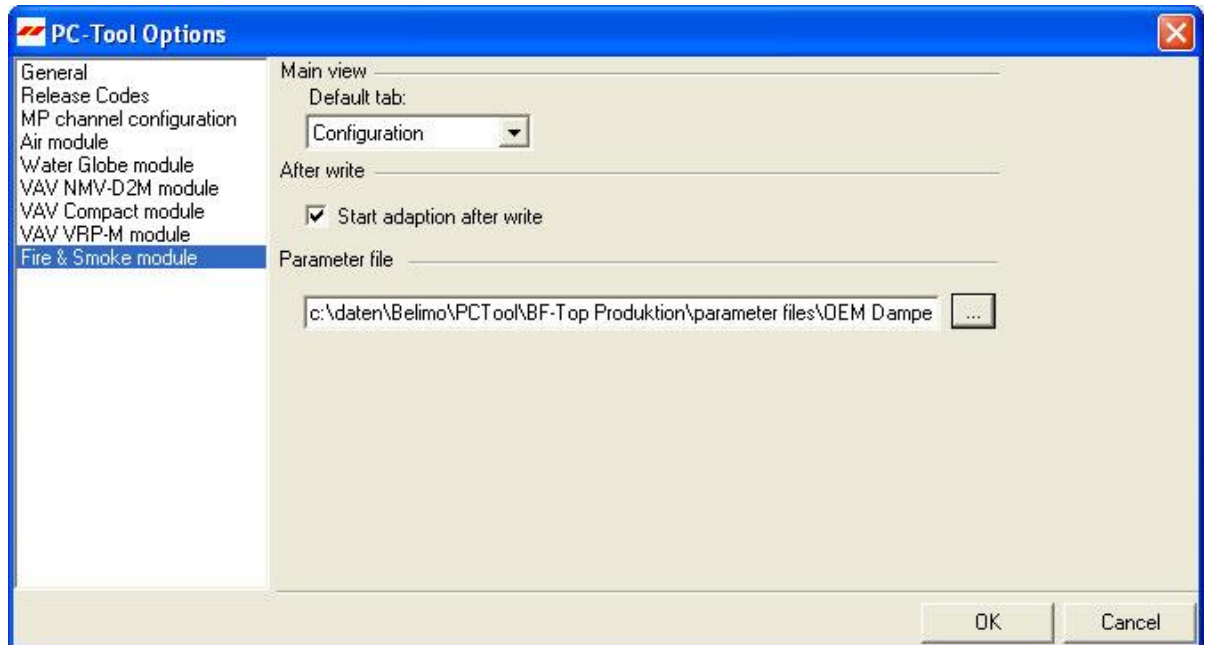

*Advanced settings dialog (fire protection module)*

### Start adaption after write

This value determines the basic setting of the "With adaption" option on the "Configuration" tab.

### Parameter file

The specified file is selected by default as the "Parameter file" whenever the "Configuration" tab is opened.

**PC-Tool V3.16 VAV-Compact module**  
**For VAV controller**  
**User Manual**  
**English**



# Table of Contents

1	Introduction.....	3
2	Service .....	4
2.1	Displaying settings .....	4
2.2	Convert units for volumetric flow.....	7
2.3	Adaptation.....	7
2.4	Synchronization.....	7
2.5	Function test.....	8
3	Configuration.....	10
3.1	Settings.....	12
3.2	Seal bit.....	15
3.3	Reset to basic manufacturer settings.....	15
4	Controller simulation.....	16
4.1	Actuator control .....	17
4.2	Test.....	17
4.2.1	Test scripts .....	18
4.3	Reading out sensors and switches .....	19
4.4	Trend recording.....	20
5	PC-Tool options.....	22

## 1 Introduction

The VAV module user manual describes the detail area [D] of the module for VAV-Compact controllers. The documentation is divided according to the three index tabs "Service", "Configuration" and "Simulation".

---

**Note**

For function and wiring, see VAV-Compact product information LMV-D2-MP, NMV-D2-MP, SMV-D2-MP

---

## 2 Service

### 2.1 Displaying settings

The Service tab gives an overview of the current settings of the VAV-Compact controller.

Type **LMV-D2-MP** SN **00831-20103-146-153**  
 Designation **Belimo** Address **MP2**  
 Position

**Service** | **Configuration** | Simulation

**Actual settings**

Control type VAV-CAV  
 Control function Y DC 2-10 V

Nominal range 94° adapted

Calibration value

Volumetric flow setting Vnom: 0 m3/h Vmax: 0 m3/h Vmin: 0 m3/h Vmid: 0 m3/h

Direction of rotation ccw Y= 100%

Synchronization at Y=0%

Torque 100%

Bus fail position Last value

Power ON No action

Gear release button Synchronization

CAV feature Standard

**Actuator information**

Firmware 01 V19  
 Config table ID 0x104B

**Data log**

Operating time 224h  
 Active time 0h  
 Stop & Go ratio 0%

**Messages**

Messages Reset Messages

Test  
 Adaption  
 Synchronization

*Service tab for full-rotation VAV controllers*

The general part of this manual describes how you can print out the controller parameters [Section 3.6.2.] or delete maintenance and fault messages [Section 3.6.3].

For linear actuators the stroke is displayed instead of the angle of rotation, and the torque instead of the positioning force.

. The synchronization at is Y=0%. The force is 100%."/>

Nominal range 95 mm programmed

Calibration value

Volumetric flow setting Vnom: 0 m3/h Vmax: 0 m3/h

Direction of stroke up Y= 100%

Synchronization at Y=0%

Force 100%

*Service tab for linear actuators (excerpt)*

Meaning of the settings

Control function	VAV-CAV (volume control equipment) or open loop operation (operation with external VAV controller, actuator and sensor function)
Control signal Y	Type of control
Sensitivity	Response sensitivity and reversal hysteresis of the control signal (only for control function "Open Loop")
Feedback U5	Type of feedback signal (conventional operation)
Range	Position range within the mechanical limits
Conductance	Box-specific parameter, set by the manufacturer
Volumetric flow settings	Operating volumetric flow settings: V'nom / V'max / V'min / V'mid (only V'nom in open loop operation)
Direction of rotation	Clockwise/counterclockwise opening dampers (for full-rotation actuators)
Direction of stroke	Up / down (for linear actuators)
Synchronization at	Stop position 0 % or 100 %
Torque	In percent of the maximum torque
Actuating force	In percent of maximum positioning force (for linear actuators)
Behavior in the event of bus failure	Behavior in the event of a communication failure
Power ON	Behavior when system is switched on or after voltage interruption
Manual button [once]	Function when gearing latch button is pressed
CAV function	Mechanical stops: Standard or compatible with NMV-D2M
Firmware	Software version of the VAV-Compact
Config table ID	Identification of the configuration table of the VAV-Compact
Operating time	Number of hours during which the actuator was connected to the power supply
Active time	Number of hours during which the actuator was mechanically in motion and connected to the power supply
Stop & Go ratio	Ratio of active time/operating time in percent. A high Stop & Go ratio indicates unstable control

## 2.2 Convert units for volumetric flow

Select Tools ▶ PC-Tool options... in the main menu.

Click the "VAV-Compact module" on the left.

With the Volume display combobox, you determine the physical units for the volumetric flow

- m<sup>3</sup>/h (cubic meters per hour)
- l/s (liters per second)
- cfm (cubic feet per minute).

This setting is for all displays, printouts, labels and writing to the log file [see General part of this manual].

## 2.3 Adaptation

In the adaptation, the actuator determines the range 0% ... 100% by approaching the mechanical limits.

To start, click the "Adaptation" button on the Service tab.

The progress of the adaptation is displayed in the status line. The actuator first moves against the programmed direction to the zero stop and then to the end stop for a completely opened damper.

The actuators can be configured so that when the supply voltage is switched on the adaptation is automatically triggered.

---

The adaptation can be blocked in certain actuators.

---

## 2.4 Synchronization

In the case of synchronization, a mechanical limit is approached in order to calibrate the position calculation.

For each actuator, it is possible to program whether synchronization will take place at the zero stop (0%) or when the damper is completely opened (100%).

To start, click the "Synchronization" button on the Service tab.

Variant You can also trigger the synchronization directly on the actuator by pressing the gearing latch button.

The progress of the synchronization is displayed in the status line. With the setting Synchronization at: Y=0%, the actuator moves against the programmed direction to the zero stop, and with the setting Synchronization at: Y=100% to the end stop where damper is completely opened.

The actuators can be configured so that when the system is switched on, the synchronization is automatically triggered.

---

The synchronization can be blocked in certain actuators.

---



## 2.5 Function test

The function test checks for opening and closing of the damper.

First of all, the drive moves to the mechanical stop according to the synchronization position. If the range is set to "adapted", movement takes place to the other stop; with "programmed", on the other hand, to the programmed range limit.

Click the "Test" button on the Service tab. The standard display is covered by the test window.

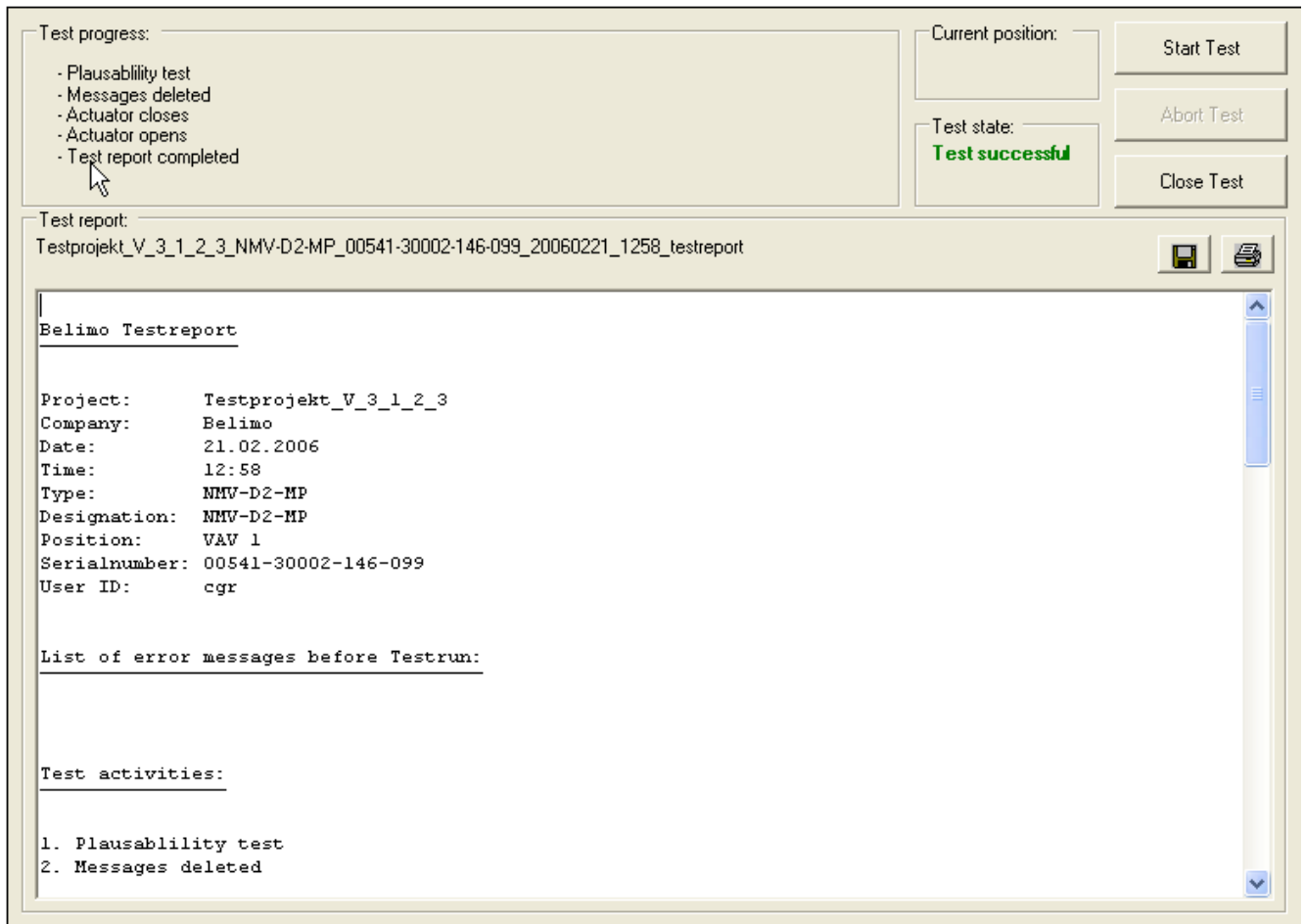

*Display of test progress and test report*

Click the Start test button.

The progress and the current position are continuously displayed.

The test report contains

- information on the project,
- the identification of the VAV-Compact controller,
- a list of fault messages pending before the start of the test,
- the test steps and the test results, and
- the current controller settings.

---

If the test reports an invalid controller configuration, change to the "Configuration" tab after ending the test. The values that are not allowed are marked with a flashing exclamation point.

---

You can save the test report as a file by clicking the floppy disk icon, and you can print it with the printer icon.

End the function test with the Close Test button. The program asks whether you want to save an unsaved test report now.

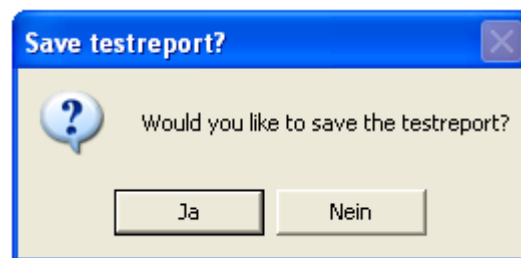

If you cancel the test early, no test report is created.

### 3 Configuration

In the "Configuration" box, parameter values can be read out from the VAV-Compact controller, changed and stored in a text file. The valid ranges for the parameter values are displayed in parentheses next to the input boxes.

"Configuration" tab for full-rotation VAV controllers

The extended input boxes in the bottom area become visible when you click "Expand".

For linear actuators, the stroke is displayed instead of the angle of rotation and the stroke direction instead of the direction of rotation.

*"Configuration" tab for linear actuators (excerpt)*

### 3.1 Settings

Controller identifier<sup>1</sup>

Designation	16 characters of any text
Position	16 characters of any text

Volumetric flow, nominal

V'nom	Nominal volumetric flow (is set by the manufacturer of the VAV box)
-------	---

Volumetric flow range for control function "VAV-CAV"

V'min	Lower limit of operating volumetric flow setting
V'max	Upper limit of operating volumetric flow setting
V'mid	CAV level between V'min and V'max
Shut-off device	sets V'min permanently to 0 m <sup>3</sup> /h (shut-off operation – closed damper)

You can convert the physical units for the volumetric flow via Tools ► PC-Tool options in the main menu [see Section 2.2.].

In the options, you can also define whether the input of the volumetric flow for V'min and V'max in percent is possible.

An existing value for V'mid is automatically adapted when V'min and V'Max are entered: If you enter V'min, V'mid is always larger than or equal to this input value. If you enter V'max on the other hand, V'mid is always less than or equal to this value.

Control function

VAV-CAV	Constant (CAV) or variable (VAV) volume control
Open loop	Operation with external VAV controller (actuator and sensor function)

Mode (positioning signal Y / feedback U5)

0 ... 10 V	Sets positioning signal Y = 0 ... 10 V, feedback U5 = volumetric flow, 0 ... 10 V
2 ... 10 V	Sets positioning signal Y = 2 ... 10 V, feedback U5 = volumetric flow, 2 ... 10 V
others	Positioning signal Y and feedback U5 are defined separately (see below)

<sup>1</sup> Only characters from the Western European character set are permitted for "Description" and "Position" (see General part, table in Section 4.3.3).

Control signal Y

0 ... 10 V	Fixed operating range 0 ... 10 V
2 ... 10 V	Fixed operating range 2 ... 10 V
Variable	Start (Y=0%) 0 ... 8 V Stop (Y=100%) 4 ... 32 V Range between start and stop at least 2 V

Feedback U5 (only active when the actuator address is set to PP)

Damper position 0 ... 10 V	Damper position 0 ... 10 V
Damper position 2 ... 10 V	Damper position 2 ... 10 V
Damper position variable	Feedback, damper position Start 0 ... 8.0 V / Stop 2 ... 10.0 V Range between start and stop at least 2 V
Volumetric flow 0 ... 10 V	Feedback, volumetric flow 0 ... 100% V'nom = 0 ... 10 V
Volumetric flow 2 ... 10 V	Feedback, volumetric flow 0 ... 100% V'nom = 2 ... 10 V
Volumetric flow variable	Feedback, volumetric flow 0 ... 100% V'nom Start 0 ... 8.0 V / Stop 2 ... 10.0 V Range between start and stop at least 2 V

Direction of rotation (for full-rotation actuators)

cw	Damper opening in the clockwise direction
ccw	Damper opening in counterclockwise direction

Stroke direction (for linear actuators)

open	Upward-opening damper (relative to the orientation of the lettering on the actuator)
down	Downward-opening damper

Range (for full-rotation actuators) / Stroke (for linear actuators)

Adapted	from the mechanical limits of certain angle of rotation range/stroke
Programmed	Angle of rotation range (full-rotation) or stroke (linear), the valid values depend on the maximum nominal setting range of the actuator

Behavior in the event of bus failure

Last setpoint	Volumetric flow according to the last received setpoint from the MP master
Open	Move to full angle of rotation/stroke (100%)
Close	Move to zero stop
Min / V'min	V'min volume
Max / V'max	V'max volume

Sensitivity (for "open loop" control function only)

Normal	Normal response sensitivity and reversal hysteresis (values depend on the actuator type)
reduced	Reduced response sensitivity and increased reversal hysteresis (values depend on the actuator type)

Synchronization at

Y = 0%	Approach of mechanical limit at zero stop (damper closed)
Y = 100%	Approach of the mechanical limit with damper completely opened

Torque (for full-rotation actuators) / Positioning force (for linear actuators)

25% ... 100%	Can be set in increments of 25%. 100% corresponds to the maximum torque / the maximum positioning force for the actuator type (see nameplate)
--------------	---

CAV function

Standard	Mechanical stops: <ul style="list-style-type: none"> <li>• Damper closed</li> <li>• V'min</li> <li>• V'max</li> <li>• Damper open</li> </ul>
NMV-D2M compatible	The CAV levels correspond to the predecessors NMV-D2M: <ul style="list-style-type: none"> <li>• Damper closed</li> <li>• V'min</li> <li>• V'mid</li> <li>• V'max</li> <li>• Damper open</li> </ul>

Power ON

Adaptation	Moves to both mechanical limits and recalculates angle-dependent parameters
Synchronization	Moves to a mechanical limit (according to the setting "Synchronization at")
Nothing	(This option is not available for actuators of the "TOP" performance class. When switched on, they must always be adapted or synchronized)

Gearing latch

Synchronization	(fix for VAV-Compact actuators)
-----------------	---------------------------------

**Note**

For function and wiring, see VAV-Compact product information LMV-D2-MP, NMV-D2-MP, SMV-D2-MP

### 3.2 Seal bit

In each actuator, volumetric flow settings are pre-programmed and are protected with an electronic seal, the so-called "seal bit".

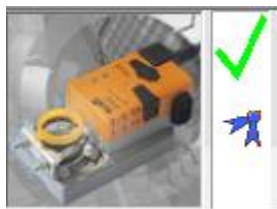

*Symbol for intact seal bit*

As soon as the value  $V_{min}$ ,  $V_{mid}$  or  $V_{max}$  is changed on the system, the seal bit is "broken". In this case, the status screen no longer displays the symbol for the seal bit.

The specified values from the manufacturer can be reactivated at any time with the function "Resetting to basic OEM settings ..." (see below). The seal bit remains broken, however.

### 3.3 Reset to basic manufacturer settings

In order to reactivate the values for  $V_{min}$ ,  $V_{max}$  and  $V_{mid}$  pre-programmed by the manufacturer, select File ▶ Reset to basic OEM settings... in the main menu.



Variant You can also trigger this function with the F6 function key or by clicking on the "Reset to basic OEM settings..." icon on the toolbar.



## 4 Controller simulation

Go to the "Simulation" tab.

The screenshot displays the 'Simulation' tab for a Belimo LMV-D2-MP VAV controller. The top section shows device information: Type LMV-D2-MP, Designation Belimo, Position, SN 00831-20103-146-153, and Address MP2. Below this are three tabs: Service, Configuration, and Simulation (which is active). The Actuator section includes options for Simulation off, Set point Y, Set point Tool (selected), Motor stop, and Open. It also shows Set point (40%), Actual flow (0 m3/h), and Damper (8%). The Sensor section has options for None (selected), Active (0...32V), Passive (850...1.6kOhm), Passive (200...60kOhm), and Switch. A 'Test' button and a 'Testfile' dropdown (set to '<No testscript>') are also present. The 'Interval' is set to 1.0 s, and there is a 'Stop Record' button. A 'Comment...' field is available. The 'Trend' section shows a graph titled 'Belimo Test AG, LMV-D2-MP,' with a y-axis from 0 to 120% and an x-axis from 16:49:41 to 16:49:52. The graph displays several data series: Set Point [%] (green line at 40%), Max Position [%] (light blue line at 100%), Min Position [%] (light blue line at 0%), Actual Volumetric Flow [%] (dotted orange line at 0%), Lower Control Limit [%] (magenta line at 0%), and Actual angle [%] (orange line at 0%). A legend at the bottom of the graph lists these series. Below the graph, a 'Values to show' section has checkboxes for: Set Point [%] (checked), Max Position [%] (checked), Min Position [%] (checked), Actual Volumetric Flow [%] (checked), Lower Control Limit [%] (checked), Actual angle [%] (checked), Actual Voltage [V] (unchecked), and Set Voltage [V] (unchecked). There is also a 'Comments' checkbox (checked).

"Simulation" tab for VAV controllers

The controller simulation is influenced when the actuator is currently carrying out an adaptation or synchronization. The function "Motor stop" overrides a running adaptation or synchronization.

## 4.1 Actuator control

Select the type of setpoint definition with the radio buttons.

- Setpoint Y: Positioning signal at the connection Y.
- Setpoint Tool: The setpoint is entered in % of the volumetric flow (0% corresponds to V'min, 100% V'max), as volumetric flow value or as positioning signal (volts).

The control is switched off when you click Motor stop.

The following overrides can be specified via radio button.

- OPEN: Damper completely opened
- CLOSED: Damper completely closed
- V'nom: Nominal volumetric flow
- V'min: Volumetric flow V'min (0%)
- V'max: Volumetric flow V'max (100%)
- V'mid: CAV volumetric flow V'mid

Measurement values

The following are displayed:

- The actual volumetric flow 0 ... 100% of V'nom
- The actual volumetric flow in m<sup>3</sup>/h, l/s or cfm
- The feedback voltage in V (U5 signal)
- The damper opening in %
- The current angle of rotation in degrees / stroke in mm.
- An active override is displayed as text, independent of whether they were specified by the PC-Tool or externally (positioning signal Y).

The trend lines can be fade in or out by selecting the corresponding checkbox.

## 4.2 Test

The function test is available for the structured test of the VAV boxes.

Several consecutive commands [see 4.2.1] are defined in a test script file. When the function is started, a trend recording is triggered.

Select test file

Select the desired script with the test file combobox.

Start test script

Click the test button ▶.

---

### Important note

Before starting the actual script, the application checks whether the air flow/system pressure is sufficient for the actuator test. (If the system pressure is insufficient, this test can last up to 3 minutes.)

---

### 4.2.1 Test scripts

The following test scripts are available.

Name of the test file	Functions
Basic_VAV_Test Max-Min 5m.bptts	V'max – 2 minutes V'min – 2 minutes
Test_VAV_0 CAV (Open-Max-Min-Close) 8m.bptts	Open – 1 ½ minutes V'max – 2 minutes V'mid – 2 minutes V'min – 2 minutes Close – 1 ½ minutes
Test_VAV_Max-75-50-25-Min-Close 3h.bptts	Open – 2 minutes V'max – ½ hour SetPoint 75% – ½ hour SetPoint 50% – ½ hour SetPoint 25% – ½ hour V'min – ½ hour
Test_VAV_Max-Auto-Min 9m.bptts	V'max – 3 minutes Auto – 3 minutes V'min – 3 minutes
Test_VAV_Max-Auto 6m.bptts	V'max – 3 minutes Auto – 3 minutes
Test_VAV_Max-Mid-Min 9m.bptts	V'max – 3 minutes V'mid – 3 minutes V'min – 3 minutes
Test_VAV_Max-Min-Max[ 1_Percent ] 37m.bptts	SetPoint 100% - 2 minutes (afterwards in steps of 1%) SetPoint 99%...0% - every 10 seconds SetPoint 1%...100% - every 10 seconds
Test_VAV_Max 3m.bptts	VMax – 3 minutes
Test_VAV_Open-Max-75-50-25-Min-Close22m.bptts	Open – 3 minutes V'max – 3 minutes SetPoint 75% – 3 minutes SetPoint 50% – 3 minutes SetPoint 25% – 3 minutes V'min – 3 minutes

### 4.3 Reading out sensors and switches

The values of integrated sensors and switches can be read out in MP mode. This function, however, must be activated in the PC-Tool options "General" in advance. Select Tools ▶ PC-Tool options... in the main menu.

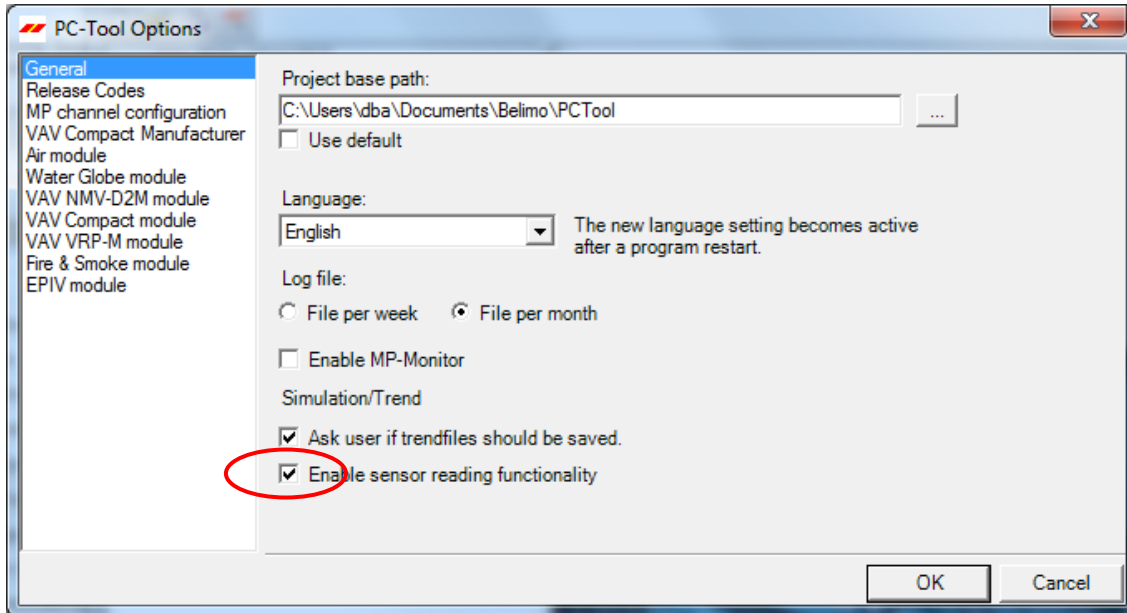

Settings for reading out sensors

On the Simulation tab, a section with the sensor values is displayed to the right of the actuator control.

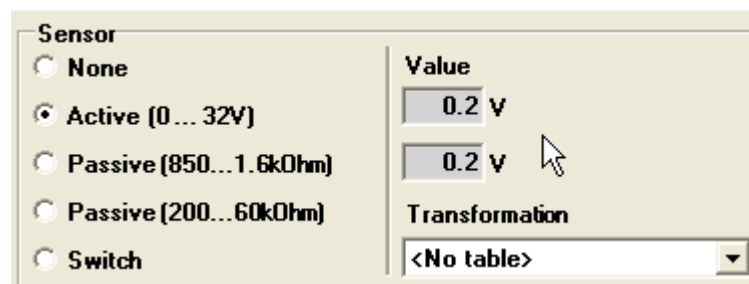

Sensor display in MP mode

Select the type of the connected sensor with the radio buttons. The value is either displayed in volts (active), ohms (passive) or as on/off (switch).

The transformation table allows you to additionally convert the raw value of the sensor into the corresponding measuring quantity (temperature etc...). (See the "Transformation table" section in the General User Manual)

### 4.4 Trend recording

During simulation, the time progress of the setpoints and actual values can be displayed in a plot. The values are saved in a trend file and can be displayed again at a later time. Furthermore, you can add any comment texts you would like.



On trend record, the trend is automatically saved to a temporary file and retained for one month. Click on the icon "Save" to save the trend with a different name and location (after stop record).

In the PC tool options "General" specify whether the program should ask for the new file name (ask user if trend files should be saved). The suggested file name can be modified before saving the file.



Click the "Trend Record" button during simulation. The display changes to a "flat" button. The recording stops when you click again.

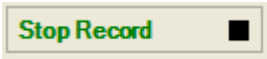

The position is queried every second by default. You can change the query interval in an input box. The permitted values are 0 to 9999 seconds, whereby the value 0 means "no waiting time" (query as quickly as possible).

If V'nom was set to 0 l/min, then the volumetric flows will be specified in % in the trend display instead of in volumetric units.

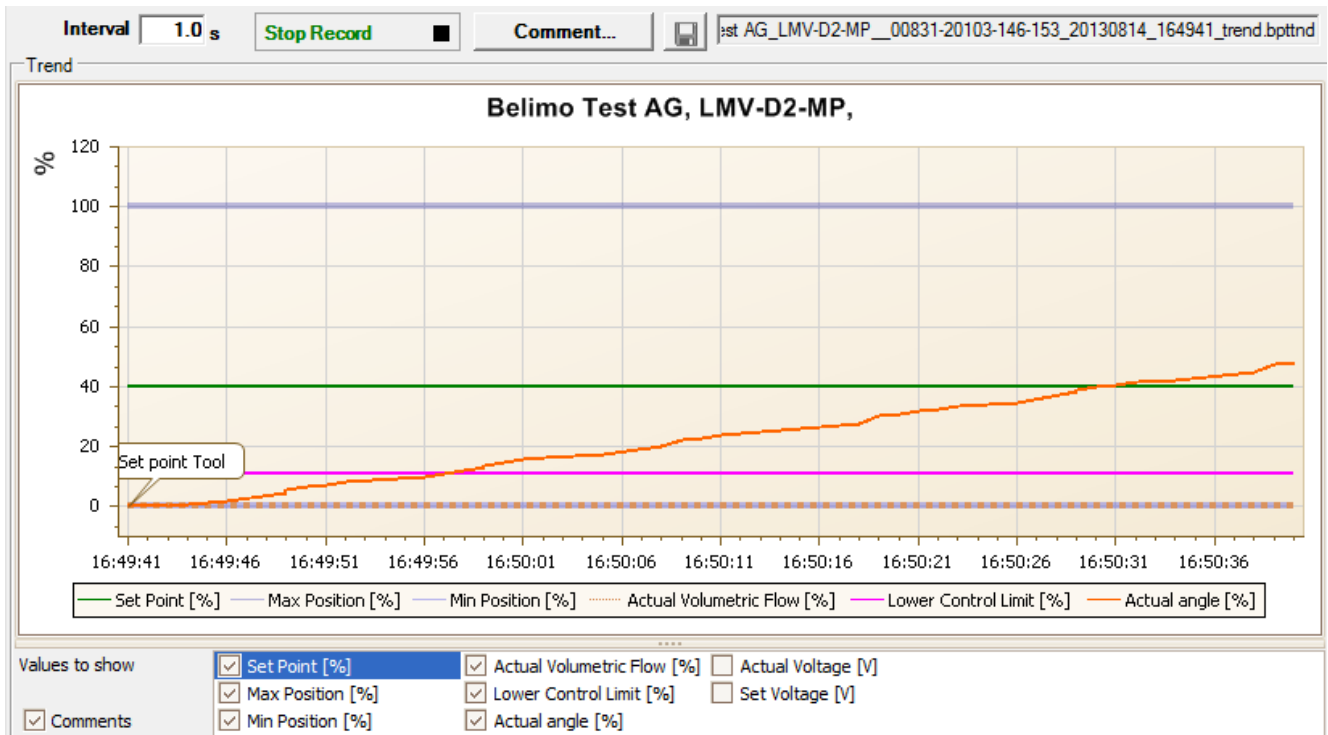

Trend plot for "VAV-CAV" control function

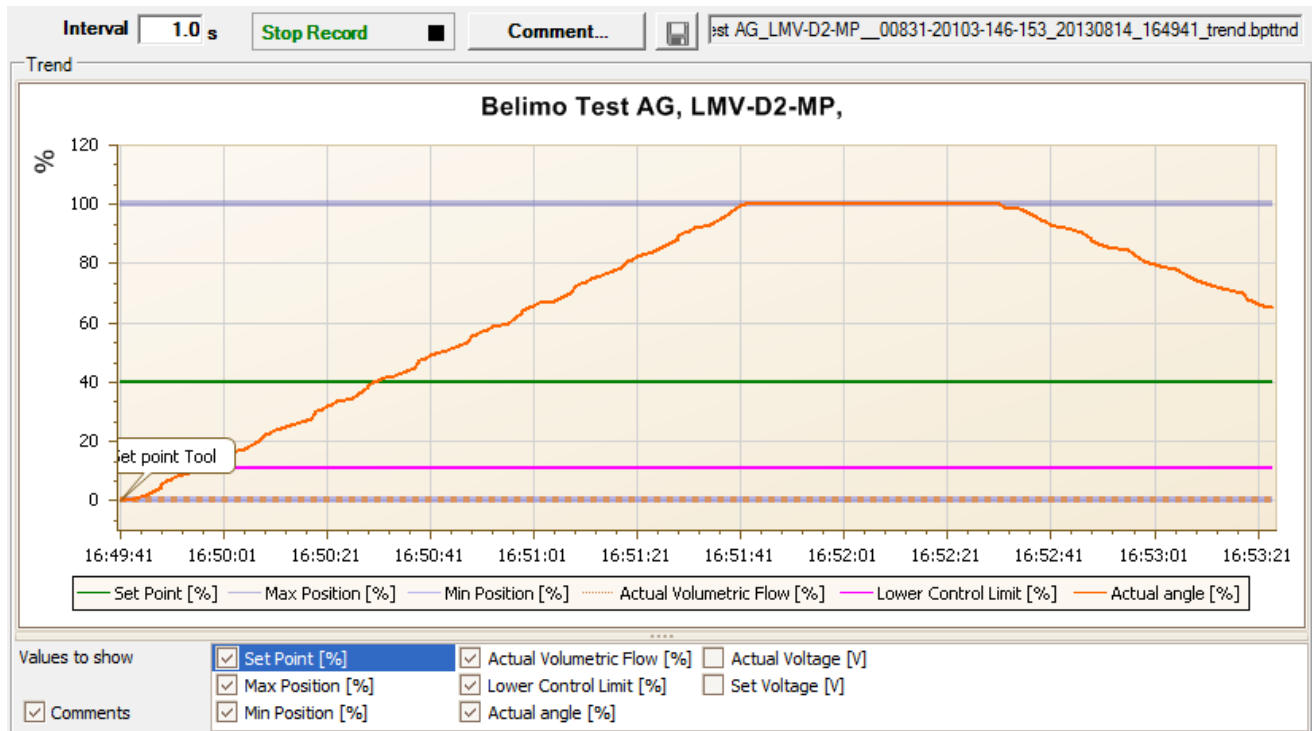

Trend plot for "open loop" control function

The Comment button allows you to enter a text at a defined time and the text is then saved in the trend file.

Override events are automatically logged with timestamp as comment.

---

If you want to record a trend for more than one hour (long-term trend), enter a value of at least 2 seconds for the interval. If the interval is shorter, too many data points will result and the time for correcting the curve between the queries can become too short.

---

## 5 PC-Tool options

Select Tools ▶ PC-Tool options... in the main menu.

Variante Click the project in the outline bar [C] with the right mouse button and select PC-Tool options.

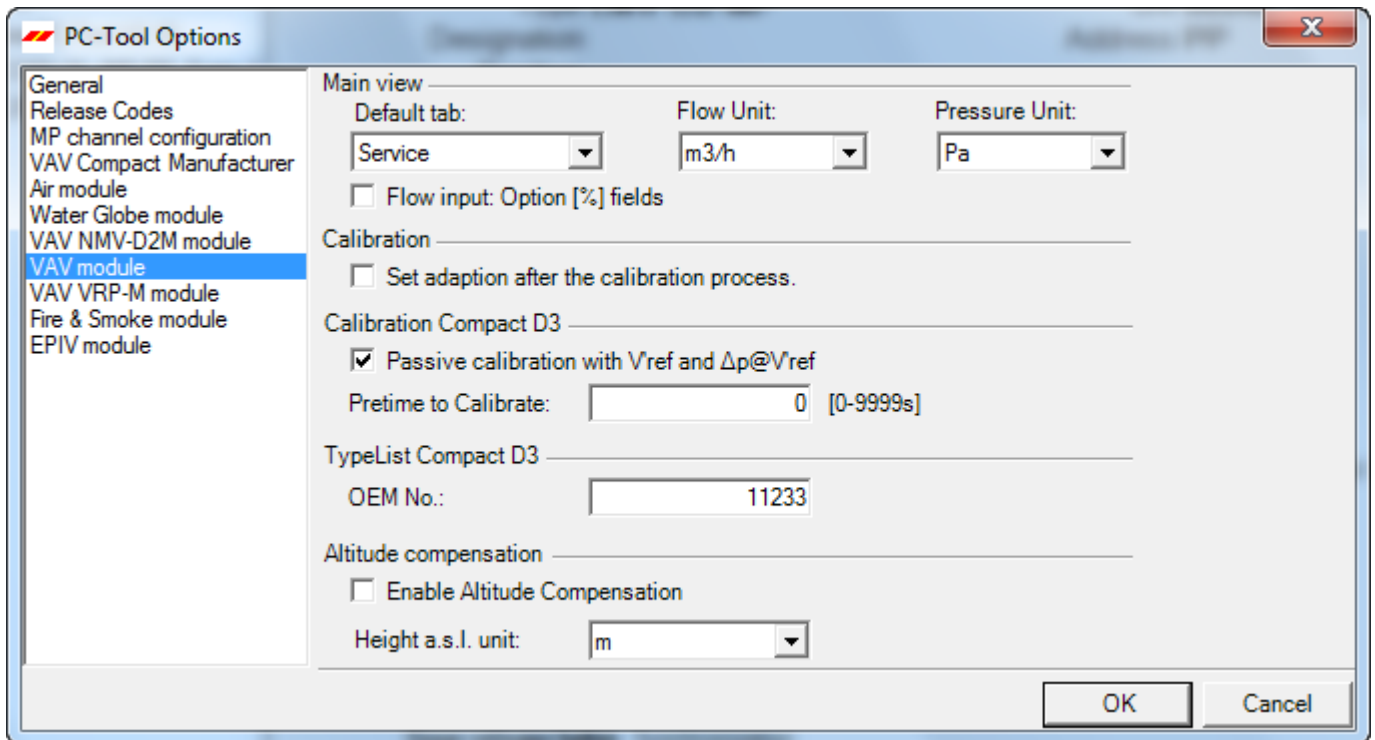

Dialog for basic settings (VAV-Compact module)

Click the "VAV-Compact module" on the left.

### Main window

Depending on the most common application, set which tab should be opened by default when the program is started with the "Default tab" combobox.

With the Volume display combobox, you determine the physical units for the volumetric flow.

- m<sup>3</sup>/h (cubic meters per hour)
- l/s (liters per second)
- cfm (cubic feet per minute)

If you would like to have the option of entering the volumetric flow as a percentage, activate the "volumetric flow input: Option [%] boxes" checkbox. Percentage values are only possible when V'Nom=0.

Calibration options will only be used in manufacturer tool.

**PC-Tool V3.16 VAV-Compact D3-module  
for VAV controller  
User Manual  
English**





# Table of Contents

1	Introduction.....	3
2	Service .....	4
2.1	Displaying settings .....	4
2.2	Convert units for volumetric flow.....	7
2.3	Adaptation.....	7
2.4	Synchronization.....	7
2.5	Function test.....	8
3	Configuration.....	10
3.1	Settings.....	11
3.2	Seal bit.....	15
3.3	Reset to basic manufacturer settings.....	15
4	Controller simulation.....	16
4.1	Actuator control .....	17
4.2	Test.....	17
4.2.1	Test scripts .....	18
4.3	Reading out sensors and switches .....	19
4.4	Trend recording.....	20
5	PC-Tool options.....	22

## 1 Introduction

The VAV D3-module user manual describes the detail area [D] of the module for VAV-Compact D3-controllers. The documentation is divided according to the three index tabs "Service", "Configuration" and "Simulation".

---

**Note**



For function and wiring, see VAV-Compact product information LMV-D2-MP, NMV-D2-MP, SMV-D2-MP

---

## 2 Service

### 2.1 Displaying settings

The Service tab gives an overview of the current settings of the VAV-Compact D3 controller.

Type <b>LMV-D3W-MP LTG</b> Designation <b>VRE-W 250_D3_ccw</b> Position <b>5592138</b>		SN <b>01347-00195-158-159</b> Address <b>PP</b>			
<b>Service</b>		<b>Configuration</b>			<b>Simulation</b>
Actual settings					
<b>Control type</b> VAV-CAV					<input type="button" value="Test"/> <input type="button" value="Adaption"/> <input type="button" value="Synchronization"/>
<b>Control function Y</b> DC 0-10 V					
<b>Feedback U5</b> Volumetric flow 0-10 V		Min: 0%	Max: 100%		
<b>Nominal range</b> 66°		adapted			
<b>Volumetric flow setting</b> V <sub>nom</sub> : 1739 m <sup>3</sup> /h		V <sub>max</sub> : 900 m <sup>3</sup> /h	V <sub>min</sub> : 0 m <sup>3</sup> /h	V <sub>mid</sub> : 870 m <sup>3</sup> /h	
<b>Δp@V<sub>nom</sub></b> 102 Pa					
<b>Angle correction curve</b> On					
<b>Direction of rotation</b> ccw					
<b>Synchronization at</b> Y=100%					
<b>Torque</b> 100%					
<b>Bus fail position</b> Last value					
<b>Power ON</b> Synchronization					
<b>Gear release button</b> Synchronization					
<b>CAV feature</b> CLOSE/V <sub>min</sub> /V <sub>max</sub> ; shut off level CLOSE:0.1V					
Actuator information					
<b>Firmware</b> 19 V02.06-0004					
<b>Config table ID</b> 0x10CC					
<b>Lifecycle Byte</b> 227: not customized: field parametrization passed					
Data log					
<b>Operating time</b> 700h					
<b>Active time</b> 0h					
<b>Stop &amp; Go ratio</b> 0%					
Messages					
<b>Messages</b> Mechanical travel increased					<input type="button" value="Reset Messages"/>

*Service tab for full-rotation VAV controllers*

The general part of this manual describes how you can print out the controller parameters [Section 3.6.2.] or delete maintenance and fault messages [Section 3.6.3].

For linear actuators the stroke is displayed instead of the angle of rotation, and the torque instead of the positioning force.

<b>Nominal range</b>	95 mm	programmed
<b>Calibration value</b>		
<b>Volumetric flow setting</b>	V <sub>nom</sub> : 0 m <sup>3</sup> /h	V <sub>max</sub> : 0 m <sup>3</sup> /h
<b>Direction of stroke</b>	up	
<b>Synchronization at</b>	Y=0%	
<b>Force</b>	100%	

*Service tab for linear actuators (excerpt)*

Meaning of the settings

Control type	VAV-CAV (volume control equipment) or open loop operation (operation with external VAV controller, actuator and sensor function)
Control signal Y	Type of control
Feedback U5	Type of feedback signal (conventional operation)
Range	Position range within the mechanical limits
Volumetric flow settings	Operating volumetric flow settings: V'nom / V'max / V'min (only V'nom in open loop operation)
$\Delta p@V'nom$	Box-specific parameter, set by the manufacturer ( $\Delta p$ when V'nom is applied to the VAV-Box)
Altitude of plant	Operating altitude of the plant
Direction of rotation	Clockwise/counterclockwise opening dampers (for full-rotation actuators)
Direction of stroke	Up / down (for linear actuators)
Synchronization at	Stop position 0 % or 100 %
Torque	In percent of the maximum torque
Actuating force	In percent of maximum positioning force (for linear actuators)
Behavior in the event of bus failure	Behavior in the event of a communication failure
Power ON	Behavior when system is switched on or after voltage interruption
Gear release button [once]	Function when gearing latch button is pressed
CAV function	Mechanical stops: Standard 0.1V Shut off, Standard 0.5V Shut off, old generation (NMV-D2M)
NFC Interace	NFC mode (read/write)
Firmware	Software version of the VAV-Compact D3
Config table ID	Identification of the configuration table of the VAV-Compact D3
Operating time	Number of hours during which the actuator was connected to the power supply
Active time	Number of hours during which the actuator was mechanically in motion and connected to the power supply
Stop & Go ratio	Ratio of active time/operating time in percent. A high Stop & Go ratio indicates unstable control

## 2.2 Convert units for volumetric flow

Select Tools ▶ PC-Tool options... in the main menu.

Click the "VAV-Compact module" on the left.

With the Volume display combobox, you determine the physical units for the volumetric flow

- m<sup>3</sup>/h (cubic meters per hour)
- l/s (liters per second)
- cfm (cubic feet per minute).

This setting is for all displays, printouts, labels and writing to the log file [see General part of this manual].

## 2.3 Adaptation

In the adaptation, the actuator determines the range 0% ... 100% by approaching the mechanical limits.

To start, click the "Adaptation" button on the Service tab.

The progress of the adaptation is displayed in the status line. The actuator first moves against the programmed direction to the zero stop and then to the end stop for a completely opened damper.

The actuators can be configured so that when the supply voltage is switched on the adaptation is automatically triggered.

---

The adaptation can be blocked in certain actuators.

---

## 2.4 Synchronization

In the case of synchronization, a mechanical limit is approached in order to calibrate the position calculation.

For each actuator, it is possible to program whether synchronization will take place at the zero stop (0%) or when the damper is completely opened (100%).

To start, click the "Synchronization" button on the Service tab.

Variant You can also trigger the synchronization directly on the actuator by pressing the gearing latch button.

The progress of the synchronization is displayed in the status line. With the setting Synchronization at: Y=0%, the actuator moves against the programmed direction to the zero stop, and with the setting Synchronization at: Y=100% to the end stop where damper is completely opened.

The actuators can be configured so that when the system is switched on, the synchronization is automatically triggered.

---

The synchronization can be blocked in certain actuators.

---

## 2.5 Function test

The function test checks for opening and closing of the damper.

First of all, the drive moves to the mechanical stop according to the synchronization position. If the range is set to "adapted", movement takes place to the other stop; with "programmed", on the other hand, to the programmed range limit.

Click the "Test" button on the Service tab. The standard display is covered by the test window.

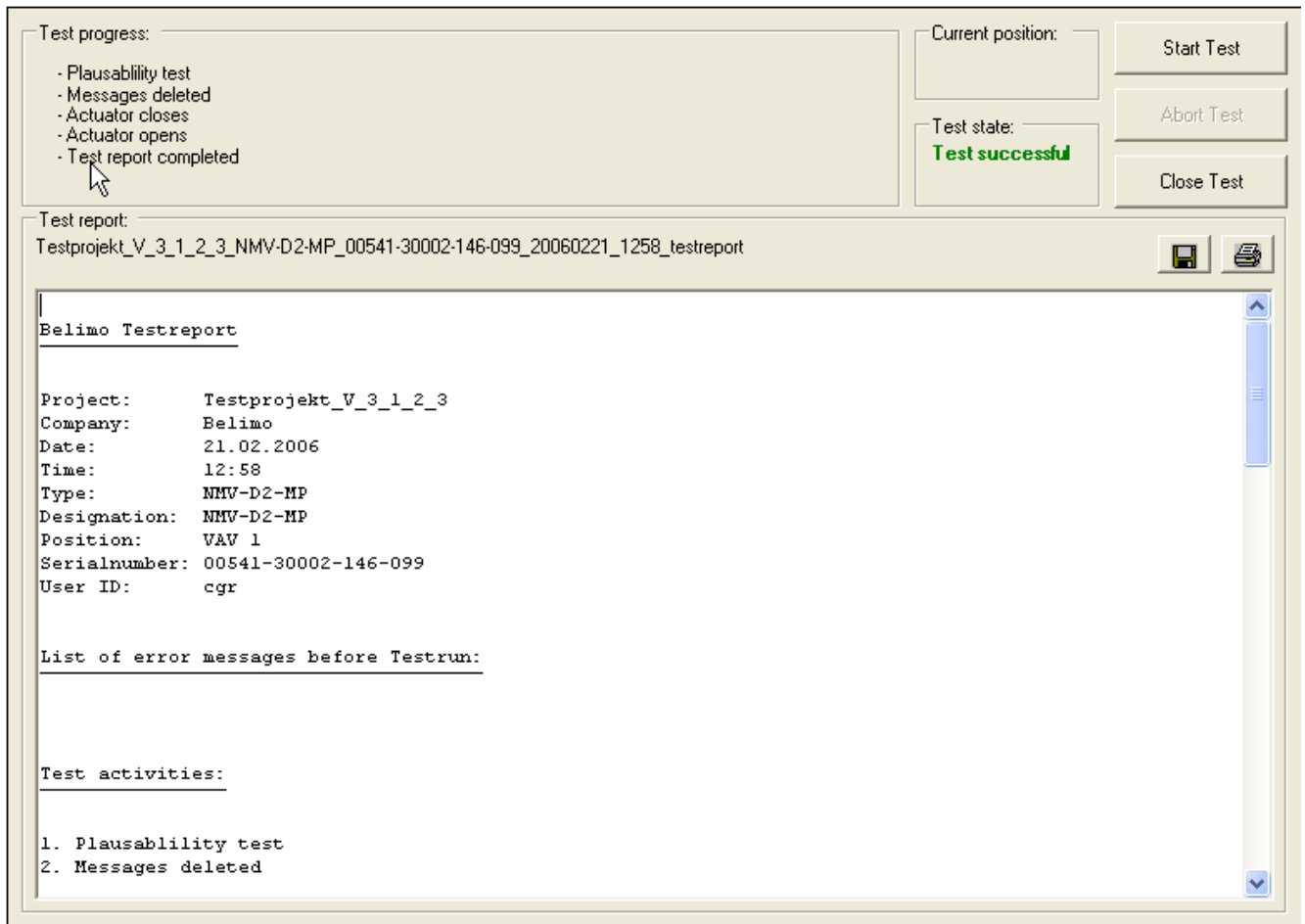

*Display of test progress and test report*

Click the Start test button.

The progress and the current position are continuously displayed.

The test report contains

- information on the project,
- the identification of the VAV-Compact D3 controller,
- a list of fault messages pending before the start of the test,
- the test steps and the test results, and
- the current controller settings.

---

If the test reports an invalid controller configuration, change to the "Configuration" tab after ending the test. The values that are not allowed are marked with a flashing exclamation point.

---

You can save the test report as a file by clicking the floppy disk icon, and you can print it with the printer icon.

End the function test with the Close Test button. The program asks whether you want to save an unsaved test report now.



If you cancel the test early, no test report is created.



### 3 Configuration

In the "Configuration" box, parameter values can be read out from the VAV-Compact D3 controller, changed and stored in a text file. The valid ranges for the parameter values are displayed in parentheses next to the input boxes.

The screenshot shows the 'Configuration' tab for a full-rotation VAV controller. At the top, it displays the device type (LMV-D3W-MP LTG), designation (VRE-W 250\_D3\_ccw), position (5592138), and address (PP). Below this, there are tabs for 'Service', 'Configuration', and 'Simulation'. The 'Configuration' tab is active, showing a 'Designation' field with 'VRE-W 250\_D3\_ccw' and a 'Position' field with '5592138'. To the right are buttons for 'Read', 'Write', and 'Store to file...'. The 'Volume flow' section includes input boxes for V<sub>nom</sub> (1739 m3/h), V<sub>max</sub> (900 m3/h), V<sub>mid</sub> (870 m3/h), and V<sub>min</sub> (0 m3/h), with their respective valid ranges shown in parentheses. The 'Direction of rotation' section has radio buttons for 'ccw' and 'cw', and a 'Mode' section with radio buttons for '0..10 V', '2..10 V', and 'other'. A 'Reduce' button is visible. The bottom section contains several dropdown menus: 'Angle of rotation' (set to 'adapted' with a value of 66°), 'Control type' (VAV-CAV), 'Control signal Y' (DC 0-10 V), 'Feedback U5' (Volumetric flow 0-10 V), 'Bus fail position' (Last value), 'CAV feature' (CLOSE/V<sub>min</sub>/V<sub>max</sub>; shut off level CLOSE:0.1V), 'Synchronization at' (Y=100%), 'Power ON' (Synchronization), and 'Torque' (100 %). A 'Gear release button' dropdown is also present.

"Configuration" tab for full-rotation VAV controllers

The extended input boxes in the bottom area become visible when you click "More".

For linear actuators, the stroke is displayed instead of the angle of rotation and the stroke direction instead of the direction of rotation.

This screenshot shows a portion of the configuration interface for a linear actuator. It features a 'Direction of stroke' section with a 'Y=' indicator, a '100%' zoom level, and a house icon. There are radio buttons for 'up' and 'down'. Below this is a 'Reduce' button with an upward-pointing triangle. The 'Stroke' parameter is shown as a dropdown menu set to 'programmed' and a text input field containing '95 mm (30..95 mm)'.

"Configuration" tab for linear actuators (excerpt)

### 3.1 Settings

#### Controller identifier<sup>1</sup>

Designation	16 characters of any text
Position	16 characters of any text

#### Volumetric flow, nominal

V'nom	Nominal volumetric flow (is set by the manufacturer of the VAV box)
-------	---

#### Volumetric flow range for control function "VAV-CAV"

V'min	Lower limit of operating volumetric flow setting
V'max	Upper limit of operating volumetric flow setting

You can convert the physical units for the volumetric flow via Tools ► PC-Tool options in the main menu [see Section 2.2.].

In the options, you can also define whether the input of the volumetric flow for V'min and V'max in percent is possible.

#### Altitude compensation

Altitude of plant	Operating altitude of the plant
-------------------	---------------------------------

You can convert the physical units for the Altitude of plant via Tools ► PC-Tool options in the main menu [see Section 2.2.].

#### Mode (positioning signal Y / feedback U5)

0..10 V	Sets positioning signal Y = 0 ... 10 V, feedback U5 = volumetric flow, 0 ... 10 V
2..10 V	Sets positioning signal Y = 2 ... 10 V, feedback U5 = volumetric flow, 2 ... 10 V
others	Positioning signal Y and feedback U5 are defined separately (see below)

#### Control signal Y

DC 0... 10 V	Fixed operating range 0 ... 10 V
DC 2... 10 V	Fixed operating range 2 ... 10 V
DC variable	Start (Y=0%) 0 ... 8 V Stop (Y=100%) 4 ... 32 V Range between start and stop at least 2 V

<sup>1</sup> Only characters from the Western European character set are permitted for "Description" and "Position" (see General part, table in Section 4.3.3).

Feedback U5 (only active when the actuator address is set to PP)

Damper position 0...10 V	Damper position 0 ... 10 V
Damper position 2...10 V	Damper position 2 ... 10 V
Damper position variable	Feedback, damper position Start 0 ... 8.0 V / Stop 2 ... 10.0 V Range between start and stop at least 2 V
Volumetric flow 0...10 V	Feedback, volumetric flow 0 ... 100% V <sup>nom</sup> = 0 ... 10 V
Volumetric flow 2...10 V	Feedback, volumetric flow 0 ... 100% V <sup>nom</sup> = 2 ... 10 V
Volumetric flow variable	Feedback, volumetric flow 0 ... 100% V <sup>nom</sup> Start 0 ... 8.0 V / Stop 2 ... 10.0 V Range between start and stop at least 2 V
$\Delta p$ , 0-10 V	Feedback pressure difference $\Delta p$ 0 ... 100% V <sup>nom</sup> = 0 ... 10 V
$\Delta p$ , 2-10 V	Feedback pressure difference $\Delta p$ 0 ... 100% V <sup>nom</sup> = 2 ... 10 V
$\Delta p$ , variabel	Feedback pressure difference $\Delta p$ 0...100% V <sup>nom</sup> Start 0 ... 8.0 Volt / Stop 2 ... 10.0 V Range between start and stop at least 2 V

Direction of rotation (for full-rotation actuators)

cw	Damper opening in the clockwise direction
ccw	Damper opening in counterclockwise direction

Stroke direction (for linear actuators)

open	Upward-opening damper (relative to the orientation of the lettering on the actuator)
down	Downward-opening damper

Range (for full-rotation actuators) / Stroke (for linear actuators)

Adapted	from the mechanical limits of certain angle of rotation range/stroke
Programmed	Angle of rotation range (full-rotation) or stroke (linear), the valid values depend on the maximum nominal setting range of the actuator

Control type

VAV-CAV	Constant (CAV) or variable (VAV) volume control
Open loop	Operation with external VAV controller (actuator and sensor function)

Behavior in the event of bus failure

Last setpoint	Volumetric flow according to the last received setpoint from the MP master
Open	Move to full angle of rotation/stroke (100%)
Close	Move to zero stop
Min / V'min	V'min volume
Max / V'max	V'max volume

Synchronization at

Y = 0%	Approach of mechanical limit at zero stop (damper closed)
Y = 100%	Approach of the mechanical limit with damper completely opened

Torque (for full-rotation actuators) / Positioning force (for linear actuators)

25% ... 100%	Can be set in increments of 25%. 100% corresponds to the maximum torque / the maximum positioning force for the actuator type (see nameplate)
--------------	---

CAV function

CLOSE/V'min/V'max; shut off level CLOSE:0.1V	Y-signal (Mode=2-10V)      Function	
	Y < 0.1 V	Close
	Y=Gnd	Close
	Y not connected (open)	None (V'min)
	Y = 24 VAC neg. half-wave	Close
	Y = 24 VAC full-wave	V'max
	Y = 24 VAC pos. half-wave	Open
CLOSE/V'min/V'max; shut off level CLOSE:0.5V	Y-signal (Mode=2-10V)      Function	
	Y < 0.5 V	Close
	Y=Gnd	Close
	Y not connected (open)	Close
	Y = 24 VAC neg. half-wave	Close
	Y = 24 VAC full-wave	V'max
	Y = 24 VAC pos. half-wave	Open

V'min / V'mid/ V'max (NMV-D2M comp.)	Y-signal (Mode=2-10V)	
	Y-signal (Mode=2-10V)	Function
	Y < 0.1 V	Close
	Y=Gnd	Close
	Y not connected (open)	None (V'min)
	Y = 24 VAC neg. half-wave	V'mid
	Y = 24 VAC full-wave	V'max
	Y = 24 VAC pos. half-wave	Open

Power ON

Adaptation	Moves to both mechanical limits and recalculates angle-dependent parameters
Synchronization	Moves to a mechanical limit (according to the setting "Synchronization at")
Nothing	(This option is not available for actuators of the "TOP" performance class. When switched on, they must always be adapted or synchronized)

Gear release button

Synchronization	(fix for VAV-Compact D3 actuators)
-----------------	------------------------------------

**Note**

For function and wiring, see VAV-Compact D3 product information LMV-D3-MP, NMV-D3-MP, SMV-D3-MP

### 3.2 Seal bit

In each actuator, volumetric flow settings are pre-programmed and are protected with an electronic seal, the so-called "seal bit".



*Symbol for intact seal bit*

As soon as the value  $V_{min}$  or  $V_{max}$  is changed on the system, the seal bit is "broken". In this case, the status screen no longer displays the symbol for the seal bit.

The specified values from the manufacturer can be reactivated at any time with the function "Resetting to basic OEM settings ..." (see below). The seal bit remains broken, however.

### 3.3 Reset to basic manufacturer settings

In order to reactivate the values for  $V_{min}$  and  $V_{max}$  pre-programmed by the manufacturer, select File ▶ Reset to basic OEM settings... in the main menu.



Variant You can also trigger this function with the F6 function key or by clicking on the "Reset to basic OEM settings..." icon on the toolbar.

## 4 Controller simulation

Go to the "Simulation" tab.

Type  
Designation **v120d95h1400cw**  
Position **LONGUS D DD**

SN **01141-20033-158-152**  
Address **MP4**

**Service**

**Configuration**

**Simulation**

<p><b>Actuator</b></p> <p><input type="radio"/> Simulation off</p> <p><input type="radio"/> Set point Y</p> <p><input type="radio"/> Set point Tool</p> <p><input type="radio"/> Motor stop</p> <p><input type="radio"/> Open</p> <p><input type="radio"/> Test</p>	<p><input checked="" type="radio"/> Close</p> <p><input type="radio"/> V'nom</p> <p><input type="radio"/> V'min</p> <p><input type="radio"/> V'max</p> <p><input type="radio"/> V'mid</p>	<p>Set point: <b>-10 %</b></p> <p>Actual flow: <b>0 %</b> <b>0 m3/h</b></p> <p><math>\Delta p</math>: <b>0 %</b> <b>0 Pa</b></p> <p>Damper: <b>0 %</b> <b>0 °</b></p> <p>Active override step: <b>Close</b></p>	<p><b>Sensor</b></p> <p><input checked="" type="radio"/> None</p> <p><input type="radio"/> Active (0 ... 32V)</p> <p><input type="radio"/> Passive (850...1.6kOhm)</p> <p><input type="radio"/> Passive (200...60kOhm)</p> <p><input type="radio"/> Switch</p>	<p>Value: <input type="text" value=""/></p> <p>Transformation: <input type="text" value=""/></p>
---	---	---	--	--

Testfile:

Interval:  Stop Record  Comment... [File Icon] [Save Icon] [Print Icon] [Close Icon] [Help Icon] [Refresh Icon] [Zoom In Icon] [Zoom Out Icon] [Full Screen Icon] [Reset Icon] [Close Icon]

File name:

Trend

**Belimo Test AG, , LONGUS D DD**

Set Point [m3/h]     Max Position [m3/h]     Min Position [m3/h]     Actual Volumetric Flow [m3/h]     Actual angle [%]

Values to show

<input checked="" type="checkbox"/> Set Point [m3/h]	<input checked="" type="checkbox"/> Actual Volumetric Flow [m3/h]	<input type="checkbox"/> Set Voltage [V]
<input checked="" type="checkbox"/> Max Position [m3/h]	<input checked="" type="checkbox"/> Actual angle [%]	<input type="checkbox"/> $\Delta p$ [%]
<input checked="" type="checkbox"/> Min Position [m3/h]	<input type="checkbox"/> Actual Voltage [V]	

Comments

"Simulation" tab for VAV controllers

---

The controller simulation is influenced when the actuator is currently carrying out an adaptation or synchronization. The function "Motor stop" overrides a running adaption or synchronization.

---

## 4.1 Actuator control

Select the type of setpoint definition with the radio buttons.

- Setpoint Y (only available in PP mode): Positioning signal at the connection Y.
- Setpoint Tool: The setpoint is entered in % of the volumetric flow (0% corresponds to V'min, 100% V'max), as volumetric flow value or as positioning signal (volts).

The control is switched off when you click Motor stop.

The following mechanical stops can be specified via radio button.

- OPEN: Damper completely opened
- CLOSED: Damper completely closed
- V'nom: Nominal volumetric flow
- V'min: Volumetric flow V'min (0%)
- V'max: Volumetric flow V'max (100%)
- V'mid: Volumetric flow V'mid

Measurement values

The following are displayed:

- The momentary volumetric flow 0 ... 100% of V'nom
- The actual volumetric flow in m<sup>3</sup>/h, l/s or cfm
- The feedback voltage in V (U5 signal)
- the current pressure difference ( $\Delta p$ ) 0 ... 100% of  $\Delta p@V'nom$ ,
- the current pressure difference ( $\Delta p$ ) in Pa,
- The damper opening in %
- The current angle of rotation in degrees / stroke in mm.
- An active mechanical stop is displayed as text, independent of whether they were specified by the PC-Tool or externally (positioning signal Y).

## 4.2 Test

The function test is available for the structured test of the VAV-CAV boxes.

Several consecutive commands [see 4.2.1] are defined in a test script file. When the function is started, a trend recording is triggered.

Select test file

Select the desired script with the test file combobox.

Start test script

Click the test button ▶.

---

### Important note

Before starting the actual script, the application checks whether the air flow/system pressure is sufficient for the actuator test. (If the system pressure is insufficient, this test can last up to 3 minutes.)

---



### 4.2.1 Test scripts

The following test scripts are available.

Name of the test file	Functions
Basic_VAV_Test Max-Min 5m.bptts	V'max – 2 minutes V'min – 2 minutes
Test_VAV_0 CAV (Open-Max-Min-Close) 8m.bptts	Open – 1 ½ minutes V'max – 2 minutes V'mid – 2 minutes V'min – 2 minutes Close – 1 ½ minutes
Test_VAV_Max-75-50-25-Min-Close 3h.bptts	Open – 2 minutes V'max – ½ hour SetPoint 75% – ½ hour SetPoint 50% – ½ hour SetPoint 25% – ½ hour V'min – ½ hour
Test_VAV_Max-Auto-Min 9m.bptts	V'max – 3 minutes Auto – 3 minutes V'min – 3 minutes
Test_VAV_Max-Auto 6m.bptts	V'max – 3 minutes Auto – 3 minutes
Test_VAV_Max-Mid-Min 9m.bptts	V'max – 3 minutes V'mid – 3 minutes V'min – 3 minutes
Test_VAV_Max-Min-Max[ 1_Percent ] 37m.bptts	SetPoint 100% - 2 minutes (afterwards in steps of 1%) SetPoint 99%...0% - every 10 seconds SetPoint 1%...100% - every 10 seconds
Test_VAV_Max 3m.bptts	VMax – 3 minutes
Test_VAV_Open-Max-75-50-25-Min-Close22m.bptts	Open – 3 minutes V'max – 3 minutes SetPoint 75% – 3 minutes SetPoint 50% – 3 minutes SetPoint 25% – 3 minutes V'min – 3 minutes

### 4.3 Reading out sensors and switches

The values of integrated sensors and switches can be read out in MP mode. This function, however, must be activated in advance in the PC-Tool options under "General". Select Tools ► PC-Tool options... in the main menu.

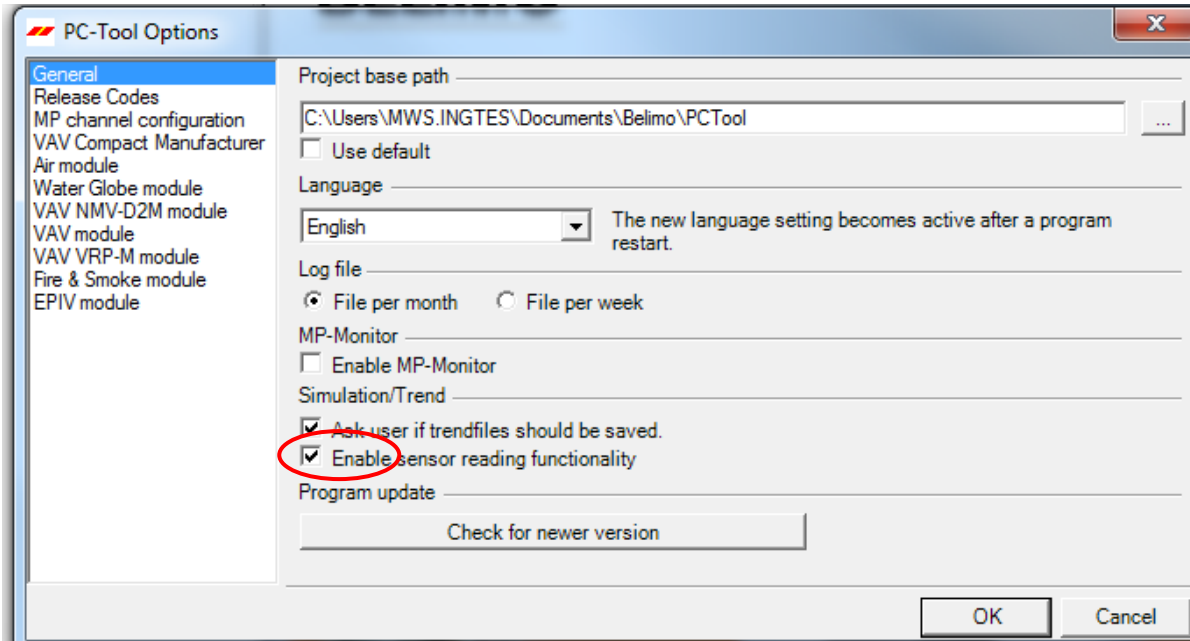

Settings for reading out sensors

On the Simulation tab, a section with the sensor values is displayed to the right of the actuator control.

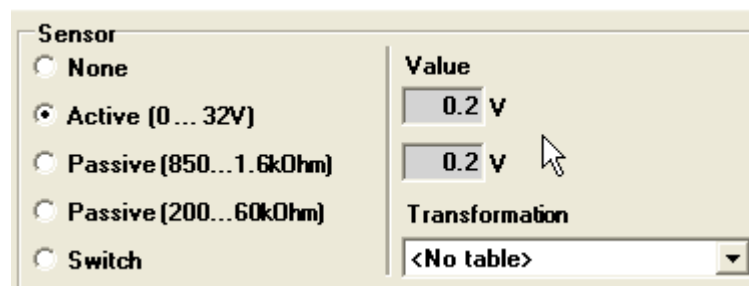

Sensor display in MP mode

Select the type of the connected sensor with the radio buttons. The value is either displayed in volts (active), ohms (passive) or as on/off (switch).

The transformation table allows you to additionally convert the raw value of the sensor into the corresponding measuring quantity (temperature etc...). (See the "Transformation table" section in the General User Manual)

### 4.4 Trend recording

During simulation, the time progress of the setpoints and actual values can be displayed in a plot. The values are saved in a trend file and can be displayed again at a later time. Furthermore, you can add any comment texts you would like.



On trend record, the trend is automatically saved to a temporary file and retained for one month. Click on the icon "Save" to save the trend with a different name and location (after stop record).

In the PC tool options "General" specify whether the program should ask for the new file name (ask user if trend files should be saved). The suggested file name can be modified before saving the file.



Click the "Trend Record" button during simulation. The display changes to a "flat" button. The recording stops when you click again.



The position is queried every second by default. You can change the query interval in an input box. The permitted values are 0 to 9999 seconds, whereby the value 0 means "no waiting time" (query as quickly as possible).

If V'nom was set to 0 l/min, then the volumetric flows will be specified in % in the trend display instead of in volumetric units.

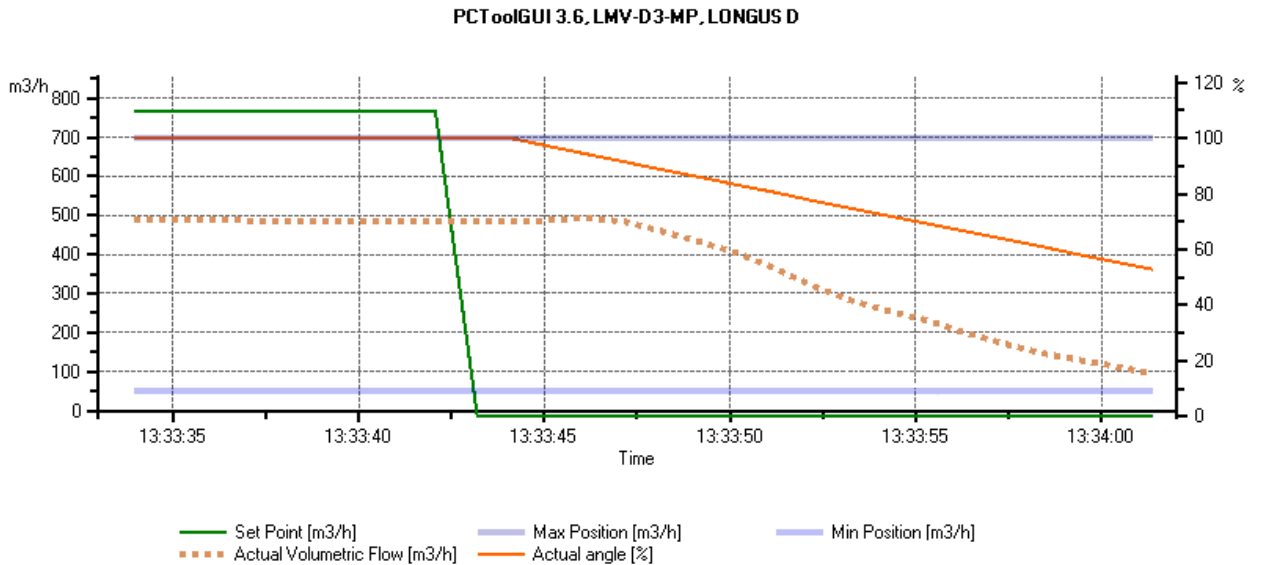

Trend plot for "Closed-Loop" control function

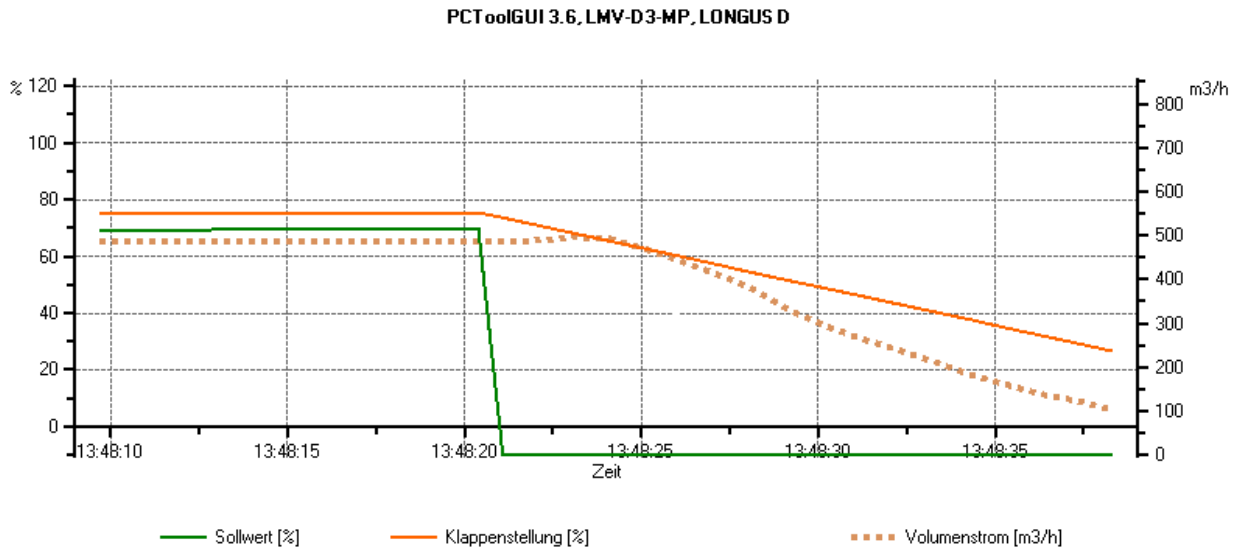

*Trend plot for "Open-Loop" control function*

The Comment button allows you to enter a text at a defined time and the text is then saved in the trend file.

Override events are automatically logged with timestamp as comment.

---

If you want to record a trend for more than one hour (long-term trend), enter a value of at least 2 seconds for the interval. If the interval is shorter, too many data points will result and the time for correcting the curve between the queries can become too short.

---

## 5 PC-Tool options

Select Tools ▶ PC-Tool options... in the main menu.

Variant Click the project in the outline bar [C] with the right mouse button and select PC-Tool options.

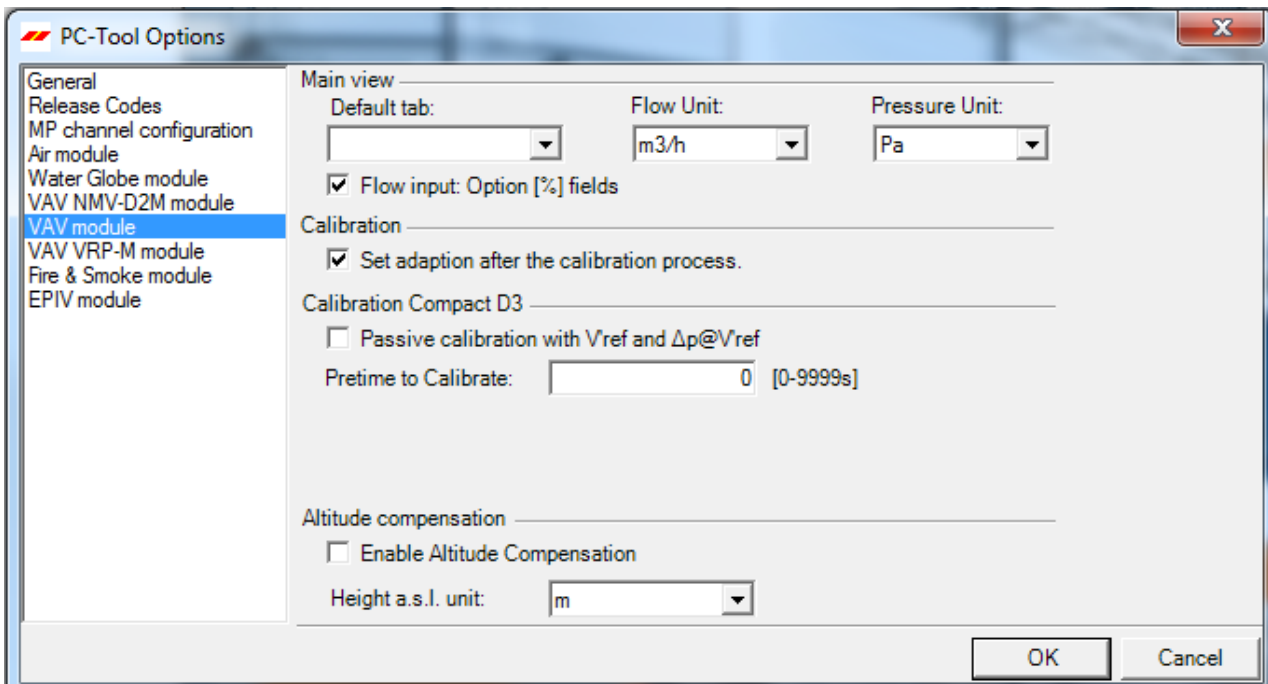

Dialog for basic settings (VAV-module)

Click the "VAV-module" on the left.

### Main window

Depending on the most common application, set which tab should be opened by default when the program is started with the "Default tab" combobox.

With the Volume display combobox, you determine the physical units for the volumetric flow.

- m<sup>3</sup>/h (cubic meters per hour)
- l/s (liters per second)
- cfm (cubic feet per minute)

If you would like to have the option of entering the volumetric flow as a percentage, activate the "volumetric flow input: Option [%] boxes" checkbox.

With the Pressure Unit combobox, you can determine the physical units for the pressure display

- Pa (Pascal)
- inWC (inch water column, 1 inWC is approx. 249 pascals at 0 °C)

### Altitude compensation

The altitude compensation can be activated through the checkbox. The actuator

is then able to supply, on the basis of the entered altitude of installation in the configuration tab, the altitude compensated differential pressure and the altitude compensated flow rate values.

With the Height a.s.l.(above sea level) unit combobox you can determine the physical units for the operating altitude of the plant

- m (Meter)
- ft (Feet)

**PC-Tool V3.16 Water stroke module**  
**For globe valve actuators**  
**User Manual**  
**English**



# Table of Contents

1	Introduction.....	3
2	Service .....	4
	2.1 Displaying settings .....	4
	2.2 Adaptation .....	5
3	Configuration .....	6
4	Controller simulation .....	10
	4.1 Actuator control .....	10
	4.2 Test .....	11
	4.3 Reading out sensors and switches .....	11
	4.4 Trend recording .....	12
5	PC-Tool options.....	14



## 1 Introduction

The "Water module" user manual describes the detail area [D] of the Water module for globe valve actuators. The documentation is divided according to the three tabs "Service", "Configuration" and "Simulation".

## 2 Service

### 2.1 Displaying settings

The Service tab gives an overview of the current settings of the actuator.

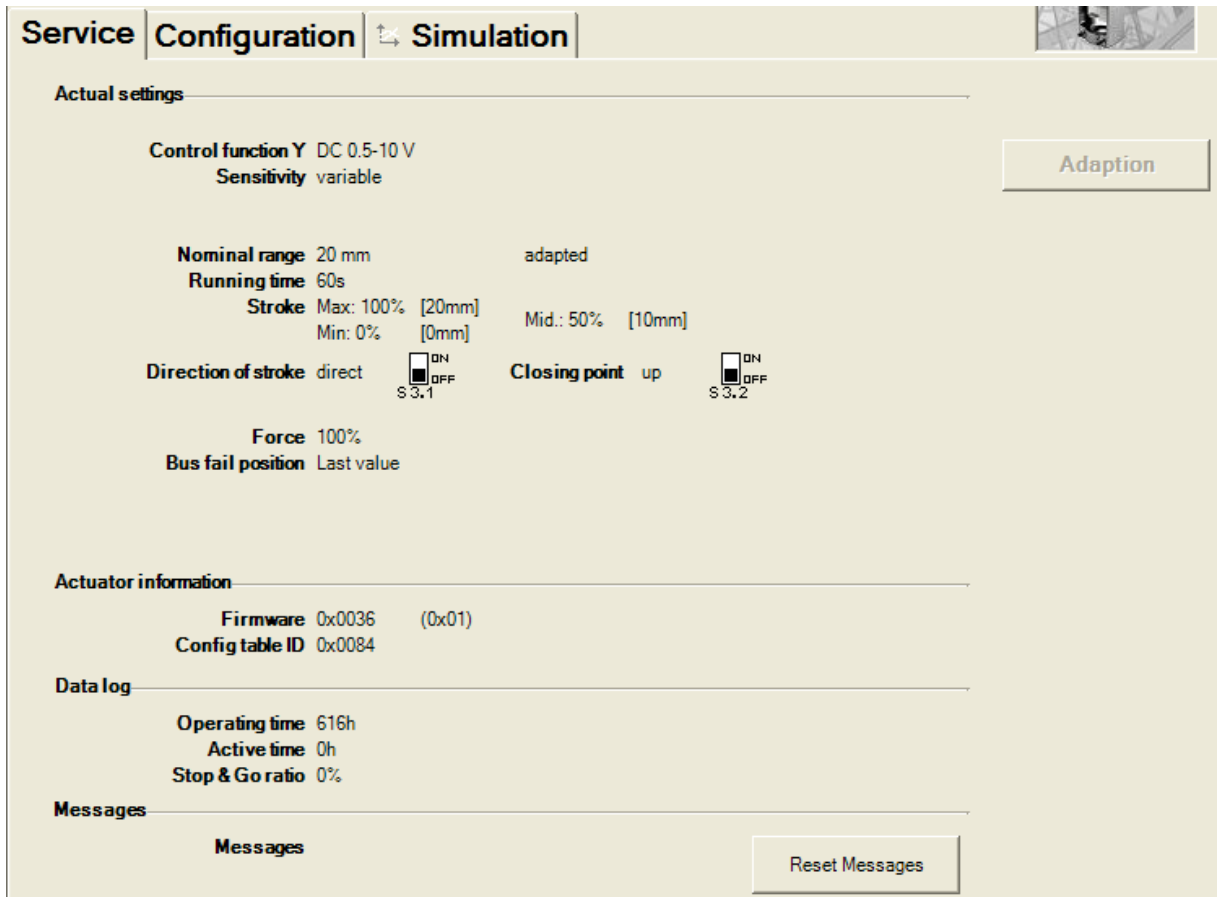

Service tab for globe valve actuators

#### Meaning of the settings

Control signal Y	Type of control
Sensitivity	Response sensitivity and reversal hysteresis of the control function
Feedback U5	Type of feedback signal
Range	Position range within the mechanical limits
Running time	Time needed to pass through the position range
Stroke	Programmed stroke range: Max / Mid / Min
Direction of rotation	Clockwise/counterclockwise (for full-rotation actuators)
Direction of stroke	Plot of stroke direction to the positioning signal: Direct / inverted (in acc. with switch S3.1)
Switching point	Top / bottom (in acc. with switch S3.2)

Actuating force	In percent of the maximum positioning force
Behavior in the event of bus failure	Behavior when communication fails
Firmware	Software version on the actuator
Config table ID	Identification of the configuration table
Operating time	Number of hours during which the actuator was connected to the power supply
Active time	Number of hours during which the actuator was mechanically in motion and connected to the power supply
Stop & Go ratio	Ratio of active time/operating time in percent. A high Stop & Go ratio indicates an unstable control.

---

Running time, range, direction of rotation and stroke are not displayed on certain actuators.

---

## 2.2 Adaptation

In the adaptation, the actuator determines the range 0% ... 100% by approaching the mechanical limits.

Click the "Adaptation" button on the Service tab.

**Variant** You can also trigger the adaptation directly on the actuator. To do this, you have to remove the cover from the actuator. To trigger the adaptation, press the S2 button on the electronic PCB.

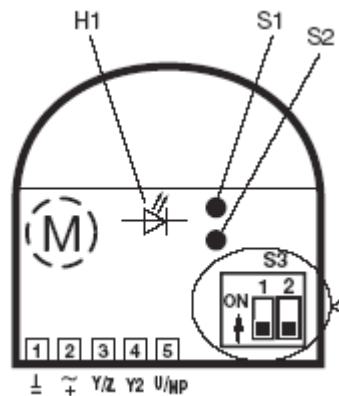

*Control element diagram with open linear actuator*

The progress of the adaptation is displayed in the status line. The actuator first moves against the programmed direction to the zero stop and then to the end stop at full stroke.

Next, the absolute values for a programmatically limited angle of rotation range (minimum, mid-position, and maximum) as well as the feedback signal U5 are recalculated and displayed.

---

The adaptation can be blocked in certain actuators.

---

### 3 Configuration

On the "Configuration" tab, you can read out parameter values from the actuator, change them and save them back to the actuator. The valid ranges for the parameter values are displayed in parentheses next to the input boxes.

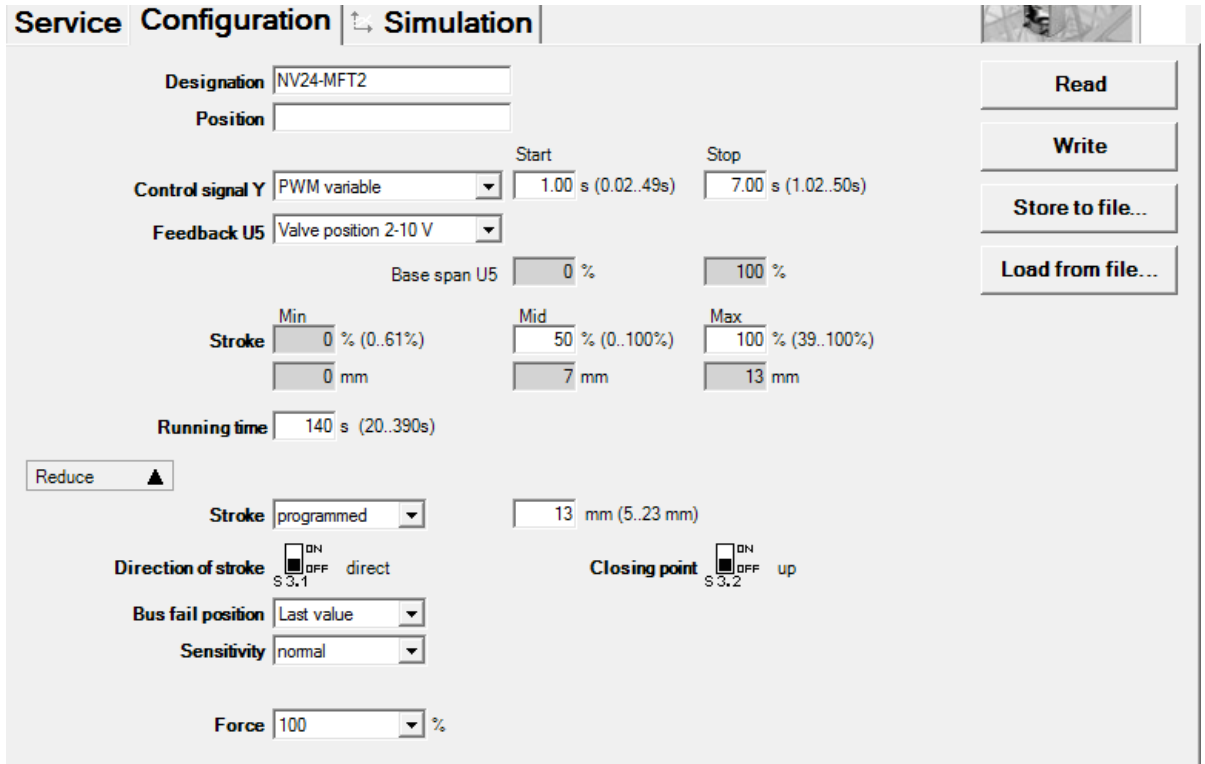

"Configuration" tab for globe valve actuators

Actuator number<sup>1</sup>

Designation	16 characters of any text
Position	16 characters of any text

<sup>1</sup> Only characters from the Western European character set are permitted for Description and Position (see General part, table in Section 4.3.3).

Control signal Y

3-point	AC voltage, positions: Open / neutral / closed
Open / closed	DC or AC voltage, 2-point
DC 0.5–10 V	(DC voltage) fixed operating range DC 0.5–10 V
DC 2–10 V modulating	(DC voltage) fixed operating range DC 2–10 V
DC variable	Start (Y=0%) 0.5 ... 30 Volt Stop (Y=100%) 2.5 ... 32 Volt Range between start and stop at least 2 V
PWM 0.02–5 s	Duration of the control impulse (pulse width modulation), fixed operating range
PWM 0.1–25.5 s	Duration of the control pulse, fixed operating range
PWM 0.59–2.93 s	Duration of the control pulse, fixed operating range
PWM variable	Start (Y=0%) minimum 0.02 seconds Stop (Y=100%) maximum 50 seconds

Feedback U5 (only active when the actuator address is set to PP)

Valve setting 2 -10V	DC voltage measurement signal, fixed range
Valve setting 0.5 -10V	DC voltage measurement signal, fixed range
Variable valve setting	DC voltage measuring signal Start 0.5...8.0 Volt / Stop 2.5 ... 10.0 V Range between start and stop at least 2 V

Scaling U5 (with "New Generation" actuator only)

Start	Position in percent, corresponds to the start value of the feedback signal
Stop	Position in percent which corresponds to the stop value of the feedback signal

Stroke

Min	Programmed lower limit of the range (cannot be changed)
Mid	Mid-position of range
Max	Programmed lower limit of the range

An existing value for Mid is automatically adapted when Max is entered: Mid is always less than or equal to this input value.

Examples of settings for control signal Y / feedback U5

**Control signal Y:** 3...8 V min: 30%, max : 70%  
**Feedback U5 :** 2...7 V start: 20%, stop: 90%

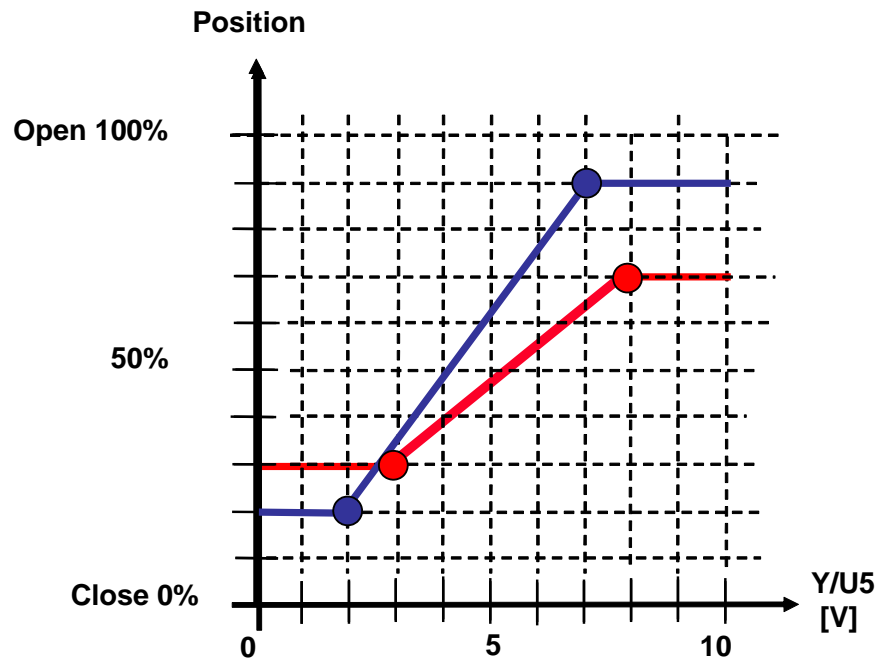

Running time

In seconds	Time needed to pass through the range limited by Min and Max (the valid range of values for the running time depends on the actuator type and the passed-through range)
------------	---

Stroke

Adapted	from the mechanical limits of certain stroke
Programmed	The valid values depend on the maximum nominal positioning range of the actuator

Stroke direction (in acc. with switch S3.1)

Direct	0% positioning signal is equivalent to 0% position feedback.
inverted	0% positioning signal is equivalent to 100% position feedback.

Closing point (in acc. with switch S3.2)

top	The linear spindle is moved into the actuator with the valve closed and the stem is moved out of the fitting.
bottom	The linear spindle is moved out of the actuator with the valve closed and the stem is moved into the fitting.

Behavior in the event of bus failure (currently cannot be changed)

Last setpoint	Position according to control signal Y
---------------	--

Sensitivity

Normal	
– Response sensitivity:	1% @ Operating range
– Reversal hysteresis	2.5% @ Operating range
Damped	
– Response sensitivity:	2% @ Operating range
– Reversal hysteresis	5% @ Operating range

Actuating force

25% ... 100%	Can be set in increments of 25%. 100% corresponds to the maximum positioning force for the actuator type (see nameplate)
--------------	--

## 4 Controller simulation

Go to the "Simulation" tab.

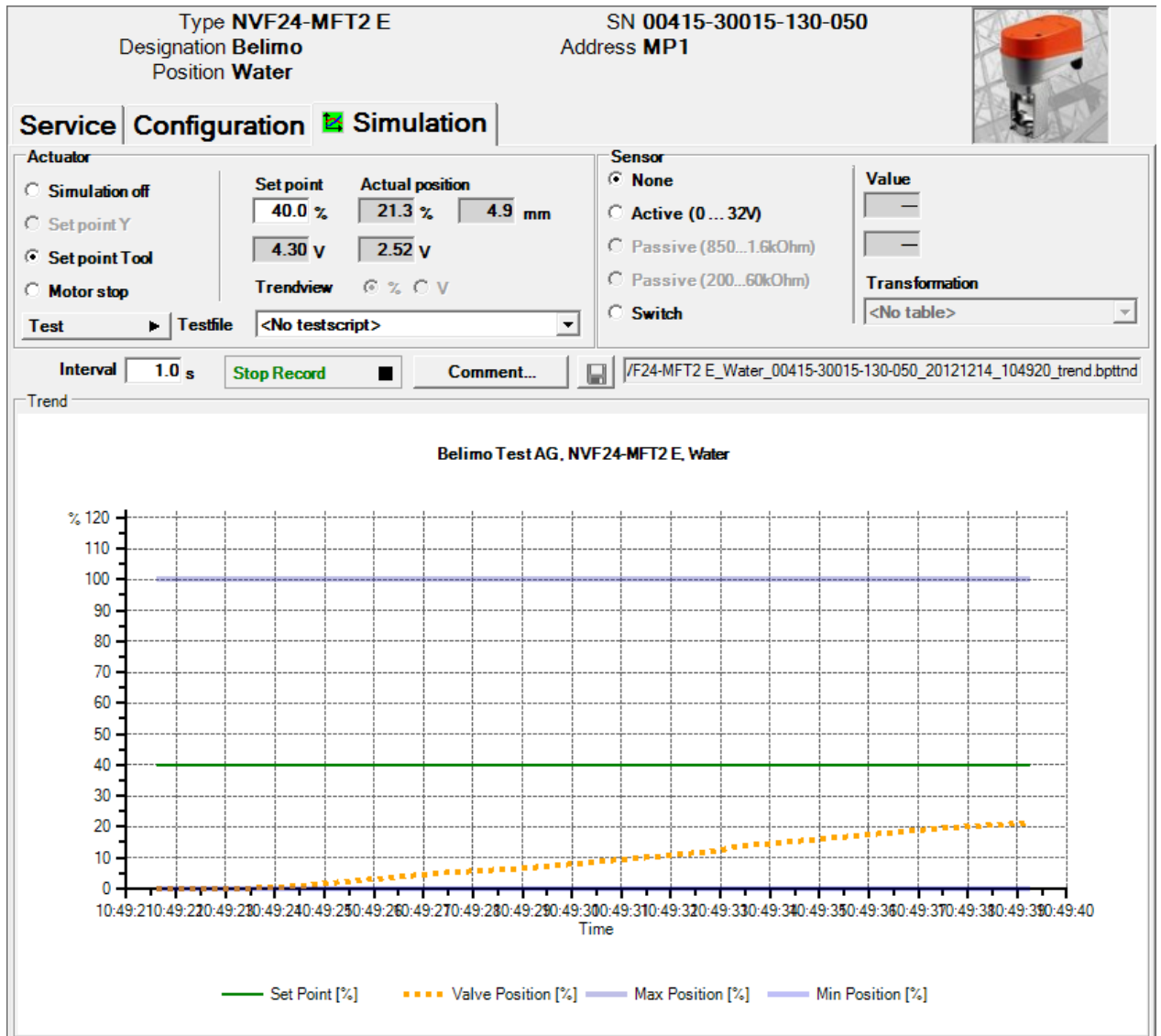

"Simulation" tab for globe valve actuators

The controller simulation is not possible while the actuator is performing an adaptation or synchronization.

### 4.1 Actuator control

Select the type of setpoint definition with the radio buttons.

- Setpoint Y (only available in PP mode): Control signal at connection Y according to selected control type (DC, PWM, open/close, 3-point).
- Setpoint Tool (not available with control type open/close or 3-point): The setpoint is entered in % of the programmed range. 0% is the minimum, 100% the maximum. The input values are converted and displayed in the units of the



corresponding control signal (volts or seconds).

The control is switched off when you click Motor stop. This function is not available with the control types open/close and 3-point.

#### Measurement values

During the simulation, the stroke is displayed in % of the absolute (mechanically limited) range in millimeters and – converted according to the scale setting – as a feedback voltage in volts.

## 4.2 Test

The test function is available for the structured testing of the Water actuator.

A number of commands which follow one another in sequence are defined in a test script file. A trend record is triggered at the start of the function.

#### Select test file

At the moment there aren't any predefined test scripts available. Custom test scripts can be produced any time and be selected through the Combobox.

Select the desired script with the Combobox test file. Only test scripts for Water modules are displayed in the Combobox.

#### Start test script

Click on the test ▶ button. The tests will begin at once.

#### Create test script

In accordance with the templates, users can also create test scripts of their own. File name must contain the character block "Water".

## 4.3 Reading out sensors and switches

The values of sensors and switches can be read out in MP mode. This function, however, must be activated in advance in the PC-Tool options under "General". Select Tools▶PC-Tool options... in the main menu.

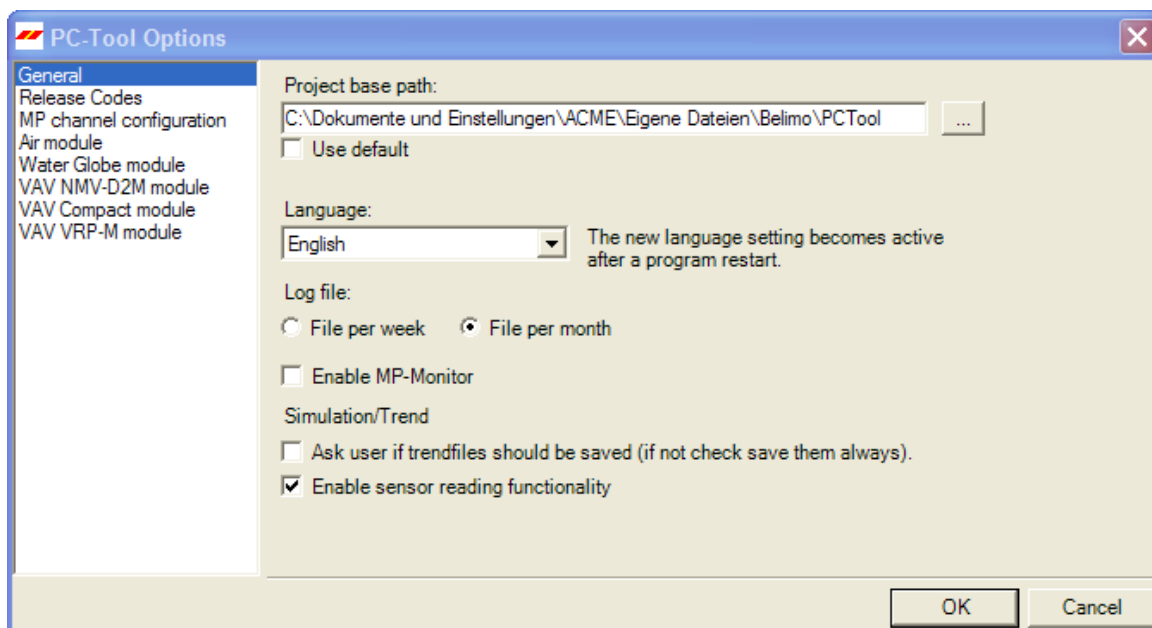

Settings for reading out sensors

On the Simulation tab, a section with the sensor values is displayed to the right of the actuator control.

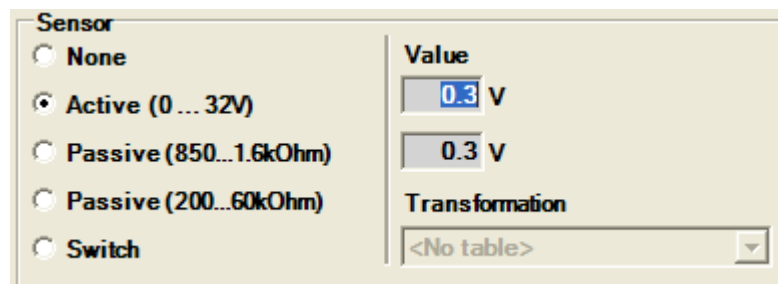

Sensor display in MP mode

Select the type of the connected sensor with the radio buttons. The value is either displayed in volts (active), ohms (passive) or as on/off (switch).

The transformation table allows you to additionally convert the raw value of the sensor into the corresponding measuring quantity (temperature etc...). (See the "Transformation table" section in the General User Manual)

#### 4.4 Trend recording

During simulation, the time progress of the setpoints and actual values can be displayed in a plot. The values are saved in a trend file and can be displayed again at a later time. Furthermore, you can add any comment texts you would like.



On trend record, the trend is automatically saved to a temporary file and retained for one month. Click on the icon "Save" to save the trend with a different name and location (after stop record).

In the PC tool options "General" specify whether the program should ask for the new file name (ask user if trend files should be saved). The suggested file name

can be modified before saving the file.



Click the "Trend Record" button during simulation. The display changes to a "flat" button. The recording stops when you click again.

The Trend View radio buttons allow you to set whether the display is given in percent of the full rotation range (%) or in volts (V).

The position is queried every second by default. You can change the query interval in an input box. The permitted values are 0 to 9999 seconds, whereby the value 0 means "no waiting time" (query as quickly as possible).

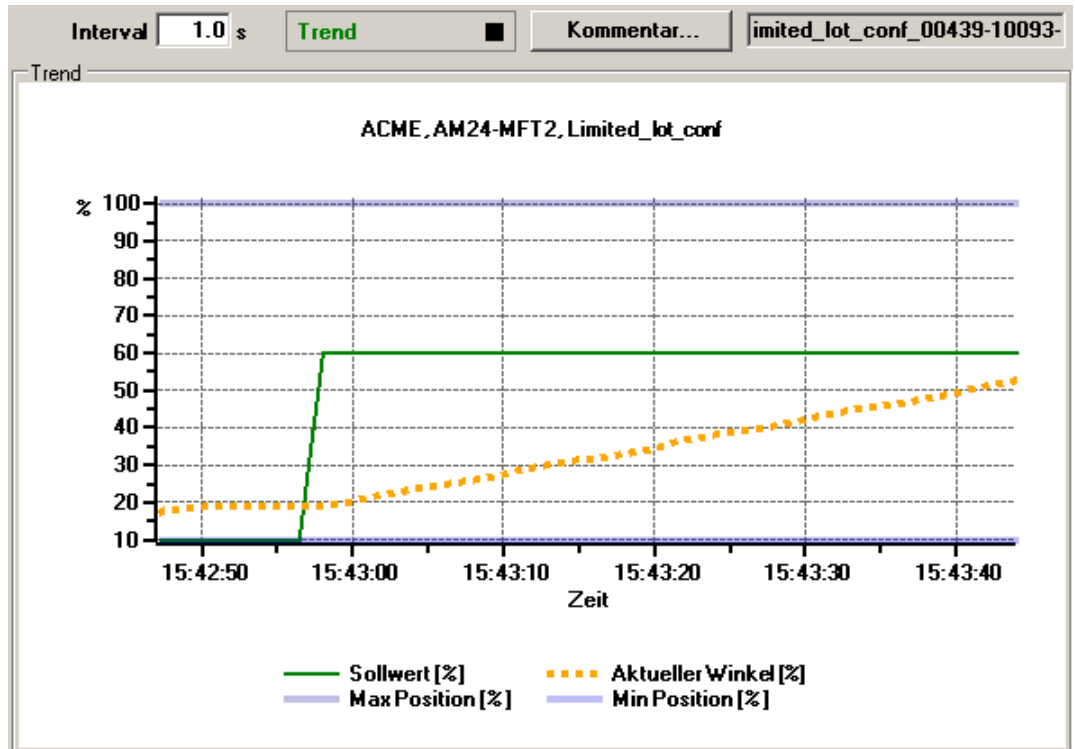

Trend plot

The Comment button allows you to enter a text at a defined time and the text is then saved in the trend file.

If you want to record a trend for more than one hour (long-term trend), enter a value of at least 2 seconds for the interval. If the interval is shorter, too many data points will result and the time for correcting the curve between the queries can become too short.

## 5 PC-Tool options

Select Tools▶PC-Tool options... in the main menu.

Variant Click the project in the outline bar [C] with the right mouse button and select PC-Tool options.

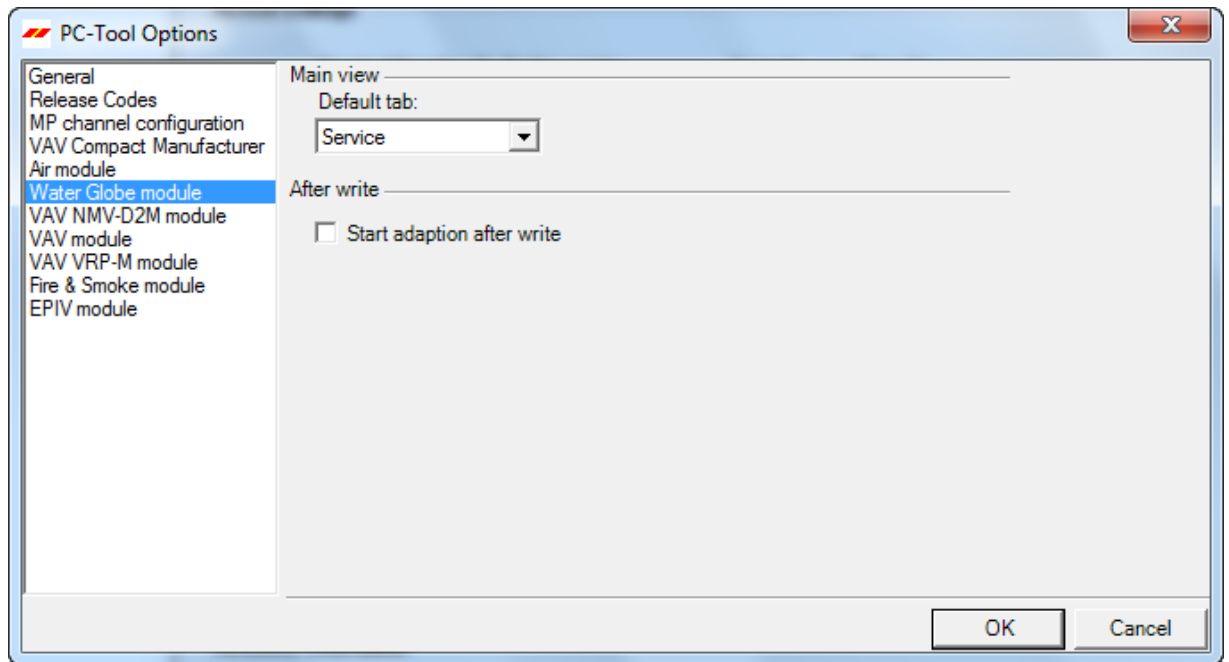

*Dialog for basic settings (Water module)*

Select "Water/globe module" on the left.

Using the combobox "Default tab", you can select the index tab you want to open by default when starting the program PC-Tool.

If an adaptation is to be performed after every programming operation, select "Start adaption after write".

Activate the „Show actuator characteristics on/off“ checkbox to show, in the Service and Configuration tabs, the actuator characteristics. This function is only available on new generation water modules.

**PC-Tool V3.16 Water globe module  
For new gen globe valve actuators**

**User Manual**

**English**



# Table of Contents

1	Introduction.....	3
2	Service .....	4
2.1	Displaying settings .....	4
2.2	Adaptation .....	5
2.3	Synchronisation.....	5
3	Configuration .....	7
4	Controller Simulation .....	12
4.1	Actuator control .....	12
4.2	Test.....	13
4.3	Reading out sensors and switches .....	13
4.4	Trend recording .....	14
5	PC-Tool options.....	16

## 1 Introduction

The "Water module" user manual describes the detail area [D] of the Water module for globe valve actuators of new generation. The documentation is divided according to the three tabs "Service", "Configuration" and "Simulation".

## 2 Service

### 2.1 Displaying settings

The Service tab gives an overview of the current settings of the actuator.

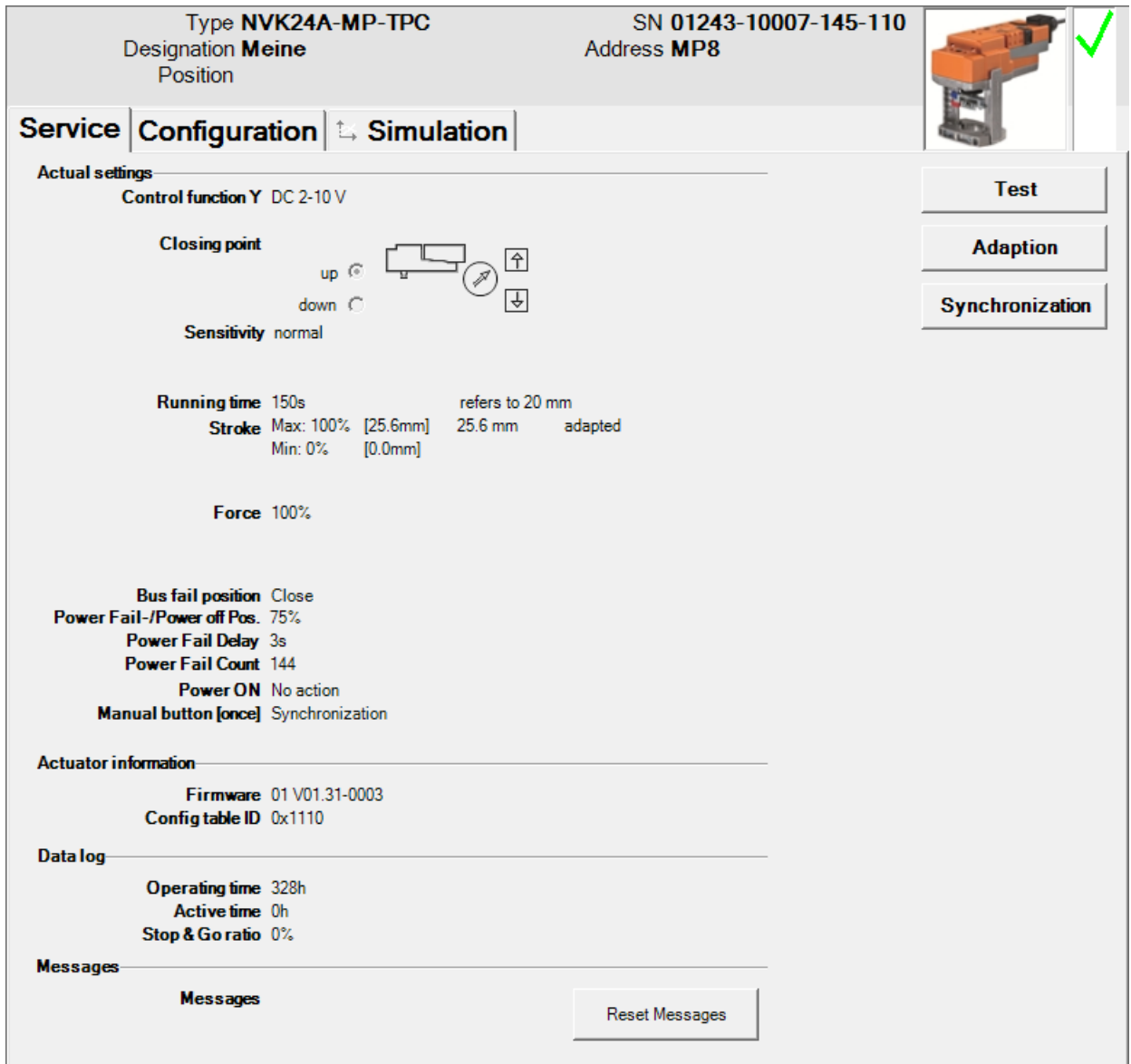

The screenshot displays the 'Service' tab for a globe valve actuator. At the top, it shows the actuator's Type (NVK24A-MP-TPC), Designation (Meine), Position, SN (01243-10007-145-110), and Address (MP8). A small image of the actuator with a green checkmark is visible in the top right corner.

The main settings area is divided into several sections:

- Actual settings:**
  - Control function Y: DC 2-10 V
  - Closing point: Includes a diagram of a globe valve with 'up' and 'down' indicators and arrows.
  - Sensitivity: normal
  - Running time: 150s (refers to 20 mm)
  - Stroke: Max: 100% [25.6mm], 25.6 mm adapted; Min: 0% [0.0mm]
  - Force: 100%
  - Bus fail position: Close
  - Power Fail-/Power off Pos.: 75%
  - Power Fail Delay: 3s
  - Power Fail Count: 144
  - Power ON: No action
  - Manual button [once]: Synchronization
- Actuator information:**
  - Firmware: 01 V01.31-0003
  - Config table ID: 0x1110
- Data log:**
  - Operating time: 328h
  - Active time: 0h
  - Stop & Go ratio: 0%
- Messages:**
  - Messages: (empty list)
  - Reset Messages: (button)

On the right side of the settings area, there are three buttons: Test, Adaption, and Synchronization.

Service tab for globe valve actuators of new generation

#### Meaning of the settings

Control signal Y	Type of control. If the control signal is inverted this will be displayed.
Closing point	.up / down (according to direction switch)
Sensitivity	Response sensitivity and reversal hysteresis of the control function



Feedback U5	Type of feedback signal. If feedback U5 is inverted this will be displayed.
Running time	Time needed to pass through the position range
Stroke	Programmed/Adapted stroke range : Max / Min
Actuating force	In percent of the maximum positioning force
Behavior in the event of bus failure	Behavior when communication fails
Power Fail-/Power off Pos.	Actuator position in case of power fail (exists only on actuators with Electronic Fail Safe modules)
Power Fail Delay	Time delay until actuator drives to power fail position. (exists only on actuators with Electronic Fail Safe modules)
Power Fail Count	Number of power Fail counts (exists only on actuators with Electronic Fail Safe modules)
Power On	Behavior at Power On of the actuator or after a power fails.
Manual button (once)	Behavior when manual button (gear release button is pressed once)
Firmware	Software version on the actuator
Configtable ID	Identification of the configuration table
Operating time	Number of hours during which the actuator was connected to the power supply
Active time	Number of hours during which the actuator was mechanically in motion and connected to the power supply
Stop & Go ratio	Ratio of active time/operating time in percent. A high Stop & Go ratio indicates an unstable control.

## 2.2 Adaptation

In the adaptation, the actuator determines the range 0% ... 100% by approaching the mechanical limits.

Click the "Adaptation" button on the Service tab.

The progress of the adaptation is displayed in the status line. The actuator first moves against the programmed direction to the zero stop and then to the end stop at full stroke.

The actuators can be configured that an adaptation automatically is triggered at Power On.

---

The adaptation can be blocked in certain actuators.

---

## 2.3 Synchronisation

In the case of synchronization, a mechanical limit is moved to in order to determine the absolute range.

For each actuator, it is possible to program whether synchronization will take place at the zero stop (0%) or at the full angle of rotation/stroke (100%).

Click the "Synchronization" button on the Service tab.

Variant You can also trigger the synchronization directly on the actuator. The necessary buttons for this can be programmed. For example, "Manual button [once]" can be assigned the synchronization function.

The progress of the synchronization is displayed in the status line. With the setting Synchronization at: Y=0%, the actuator moves against the programmed direction to the zero stop, and with the setting Synchronization at: Y=100% to the end stop at the fully open valve.

The actuators can be configured that an synchronization automatically is triggered at Power On.

---

The synchronization can be blocked in certain actuators.

---

### 3 Configuration

On the "Configuration" tab, you can read out parameter values from the actuator, change them and save them back to the actuator. The valid ranges for the parameter values are displayed in parentheses next to the input boxes.

"Configuration" tab for globe valve actuators

Actuator number<sup>1</sup>

Designation	16 characters of any text
Position	16 characters of any text

<sup>1</sup> Only characters from the Western European character set are permitted for Description and Position (see General part, table in Section 4.3.3).

Control signal Y

3-point	AC voltage, positions: Open / neutral / closed
Open / closed	DC or AC voltage, 2-point
DC 0–10 V	(DC voltage) Fixed operating range DC 0–10 V
DC 2–10 V modulating	(DC voltage) Fixed operating range DC 2–10 V
DC variable	Start (Y=0%) 0.5 ... 30 V Stop (Y=100%) 2.5 ... 32 V Range between start and stop at least 2 V
PWM 0.02–5 s	Duration of the control pulse (pulse width modulation), fixed operating range
PWM 0.1–25.5 s	Duration of the control pulse, fixed operating range
PWM 0.59–2.93 s	Duration of the control pulse, fixed operating range
PWM variable	Start (Y=0%) minimum 0.02 seconds Stop (Y=100%) maximum 50 seconds

Control signal Y inverted

On (checked)	Control signal Y will be inverted (smallest voltage = Max)
Off (not checked)	Stellsignal Y normal (highest voltage = Max)

Closing point (according to switch position)

up	In the closed valve position, the actuator spindle is retracted, and the valve stem is extended from the valve.
down	In the closed valve position, the actuator spindle is extended, and the valve stem is retracted into the valve.

Feedback U5 (only active when the actuator address is set to PP)

Valve setting 2 -10V	DC voltage measurement signal, fixed range
Valve setting 0.5 -10V	DC voltage measurement signal, fixed range
Variable valve setting	DC voltage measuring signal Start 0.5...8.0 Volt / Stop 2.5 ... 10.0 V Range between start and stop at least 2 V

Feedback U5 inverted

on	Feedback U5 is inverted (smallest voltage = Max Position)
off	Feedback U5 normal (highest voltage = Max Position)

Scaling U5 (with "New Generation" actuator only)

Start	Position in percent, corresponds to the start value of the feedback signal
Stop	Position in percent which corresponds to the stop value of the feedback signal

Examples of settings for control signal Y / feedback U5

**Control signal Y:** 3...8 V min: 30%, max : 70%

**Feedback U5 :** 2...7 V start: 20%, stop: 90%

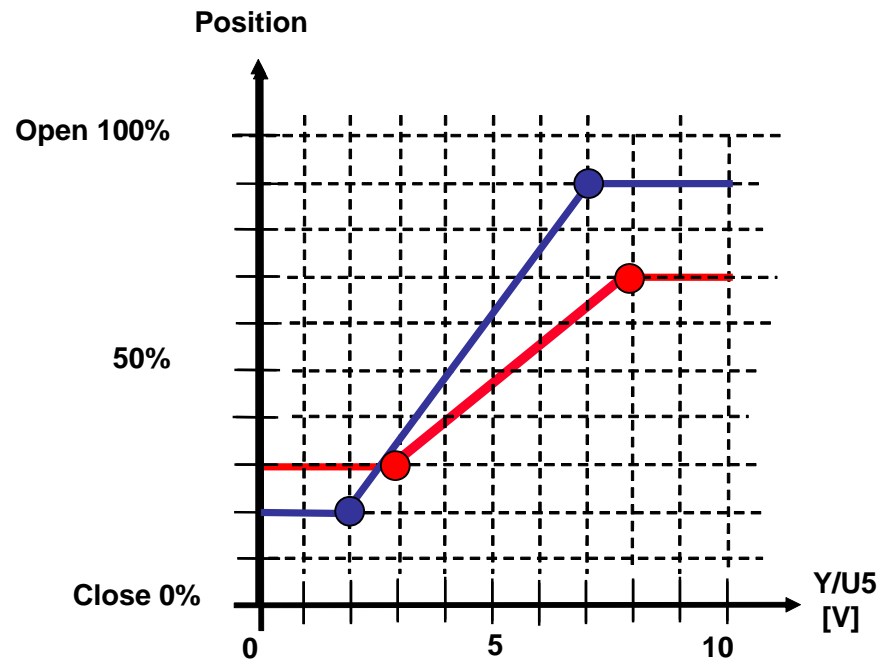

Stroke

Min	Programmed lower limit of the range (cannot be changed)
Max	Programmed lower limit of the range

Stroke

Adapted	from the mechanical limits of certain stroke
Programmed	The valid values depend on the maximum nominal positioning range of the actuator

Running time (Actuating Time)

In seconds	The running time in seconds refers always to the nominal stroke of the actuator independent of the range between Min and Max setting. When changing Min and Max the running time will change.  (The valid range of running time depends on actuator type and the adjusted range.)
In seconds/mm	The actuating time (running time/nominal range) in s/mm is constant. When changing Min and Max value the actuating time keeps constant.  In case of constant speed the value is calculated according to the formula running time/reference distance.

Behavior in the event of bus failure

Last value	Position according to control signal Y
Open	Move to full angle of rotation/stroke (100 %)
Close	Move to zero stop
Fast Close	Close with maximum speed

Sensitivity

normal	
– Response sensitivity:	1% @ Operating range
– Reversal hysteresis	2.5% @ Operating range
reduced	
– Response sensitivity:	2% @ Operating range
– Reversal hysteresis	5% @ Operating range

Actuating force

100%	value can't be adjusted, it's read only
------	---

Power ON

Synchronization	Moves to a mechanical limit (according to the setting "Synchronization at")
Adaptation	Moves to both mechanical limits and recalculates angle-dependent parameters
Nothing	

Power Fail-/Power off Position (only with Electronic Fail Safe module)

in %	Emergency Position at Power Fail (can only be changed when poti is in "Tool" position)
------	--

Power Fail Delay (only with Electronic Fail Safe module)

in seconds	Time delay until actuator drives to emergency position in power fail case.
------------	--

Manual button [once]

Synchronization	Moves to a mechanical limit (according to the setting "Synchronization at") when the manual button is pressed once or twice respectively
Adaptation	Moves to both mechanical limits and recalculates angle-dependent parameters when the manual button is pressed once or twice respectively

---

Note: For "New Generation" actuators (types MF, MP), the function Manual button [twice] is not available.

---

## 4 Controller Simulation

Go to the "Simulation" tab.

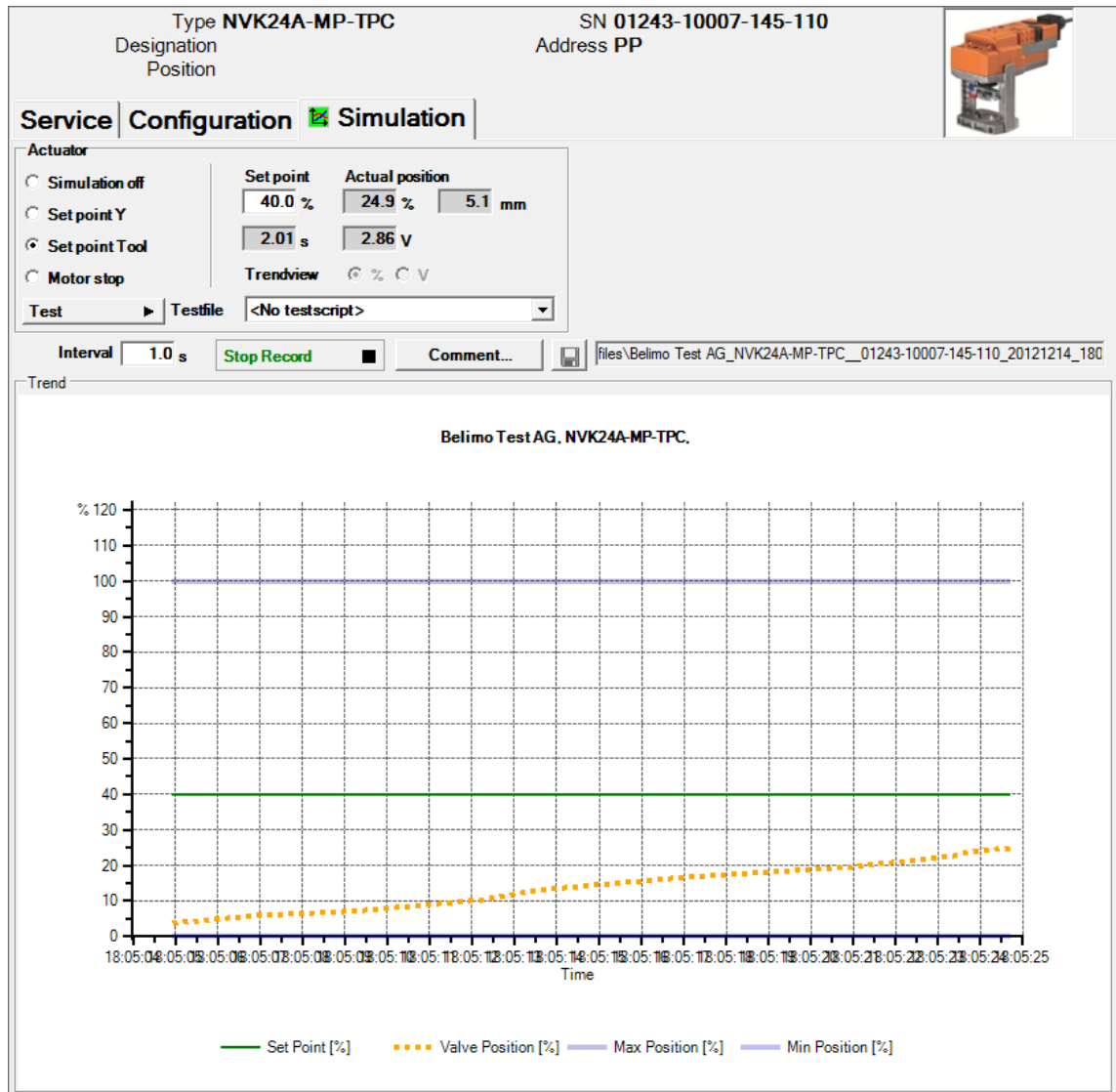

"Simulation" tab for globe valve actuators

---

The controller simulation is not possible while the actuator is performing an adaptation or synchronization.

---

### 4.1 Actuator control

Select the type of setpoint definition with the radio buttons.

- Setpoint Y (only available in PP mode): Control signal at connection Y according to selected control type (DC, PWM, open/close, 3-point).
- Setpoint Tool (not available with control type open/close or 3-point): The setpoint is entered in % of the programmed range. 0% is the minimum, 100% the maximum. The input values are converted and displayed in the units of the cor-



responding control signal (volts or seconds).

The control is switched off when you click Motor stop. This function is not available with the control types open/close and 3-point.

#### Measurement values

During the simulation, the stroke is displayed in % of the absolute (mechanically limited) range in millimeters and – converted according to the scale setting – as a feedback voltage in volts.

## 4.2 Test

The test function is available for the structured testing of the Water NG actuator.

A number of commands which follow one another in sequence are defined in a test script file. A trend record is triggered at the start of the function.

#### Select test file

At the moment there aren't any predefined test scripts available. Custom test scripts can be produced any time and selected through the Combobox.

Select the desired script with the Combobox test file. Only test scripts for Water NG modules are displayed in the Combobox.

#### Start test script

Click on the test ▶ button. The tests will begin at once.

#### Create test script

In accordance with the templates, users can also create test scripts of their own. File name must contain the character block "Water".

## 4.3 Reading out sensors and switches

The values of sensors and switches can be read out in MP mode. This function, however, must be activated in advance in the PC-Tool options under "General". Select Tools▶PC-Tool options... in the main menu.

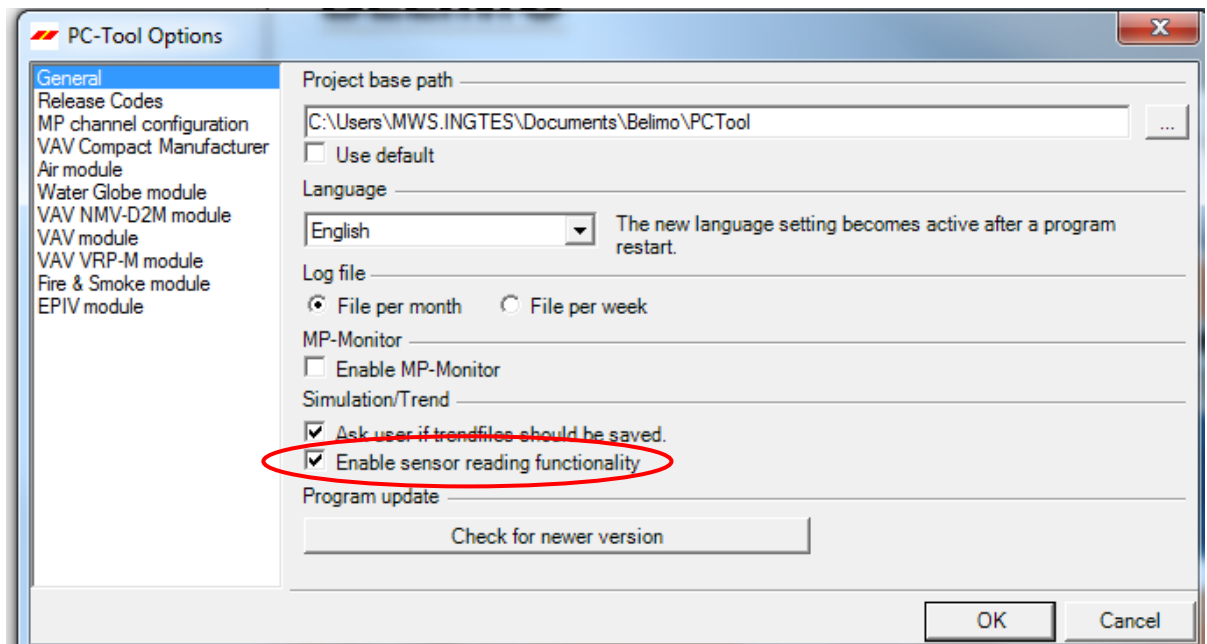

Settings for reading out sensors

On the Simulation tab, a section with the sensor values is displayed to the right of the actuator control.

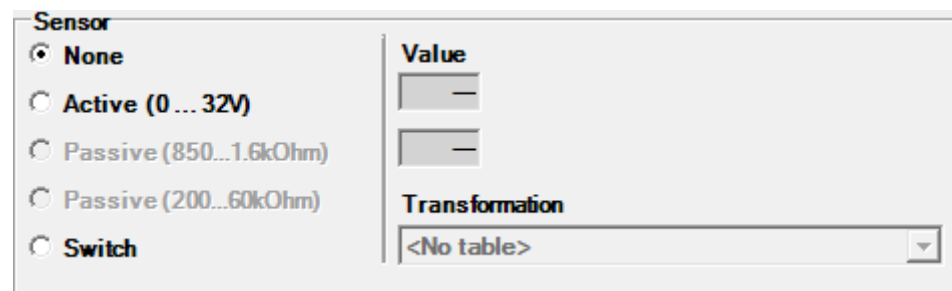

Sensor display in MP mode

Select the type of the connected sensor with the radio buttons. The value is either displayed in volts (active), ohms (passive) or as on/off (switch).

The transformation table allows you to additionally convert the raw value of the sensor into the corresponding measuring quantity (temperature etc...). (See the "Transformation table" section in the General User Manual)

#### 4.4 Trend recording

During simulation, the time progress of the setpoints and actual values can be displayed in a plot. The values are saved in a trend file and can be displayed again at a later time. Furthermore, you can add any comment texts you would like.



On trend record, the trend is automatically saved to a temporary file and retained for one month. Click on the icon "Save" to save the trend with a different name and location (after stop record).

In the PC tool options "General" specify whether the program should ask for the new file name (ask user if trend files should be

saved). The suggested file name can be modified before saving the file.



Click the "Trend Record" button during simulation. The display changes to a "flat" button. The recording stops when you click again.

The Trend View radio buttons allow you to set whether the display is given in percent of the full rotation range (%) or in volts (V).

The position is queried every second by default. You can change the query interval in an input box. The permitted values are 0 to 9999 seconds, whereby the value 0 means "no waiting time" (query as quickly as possible).

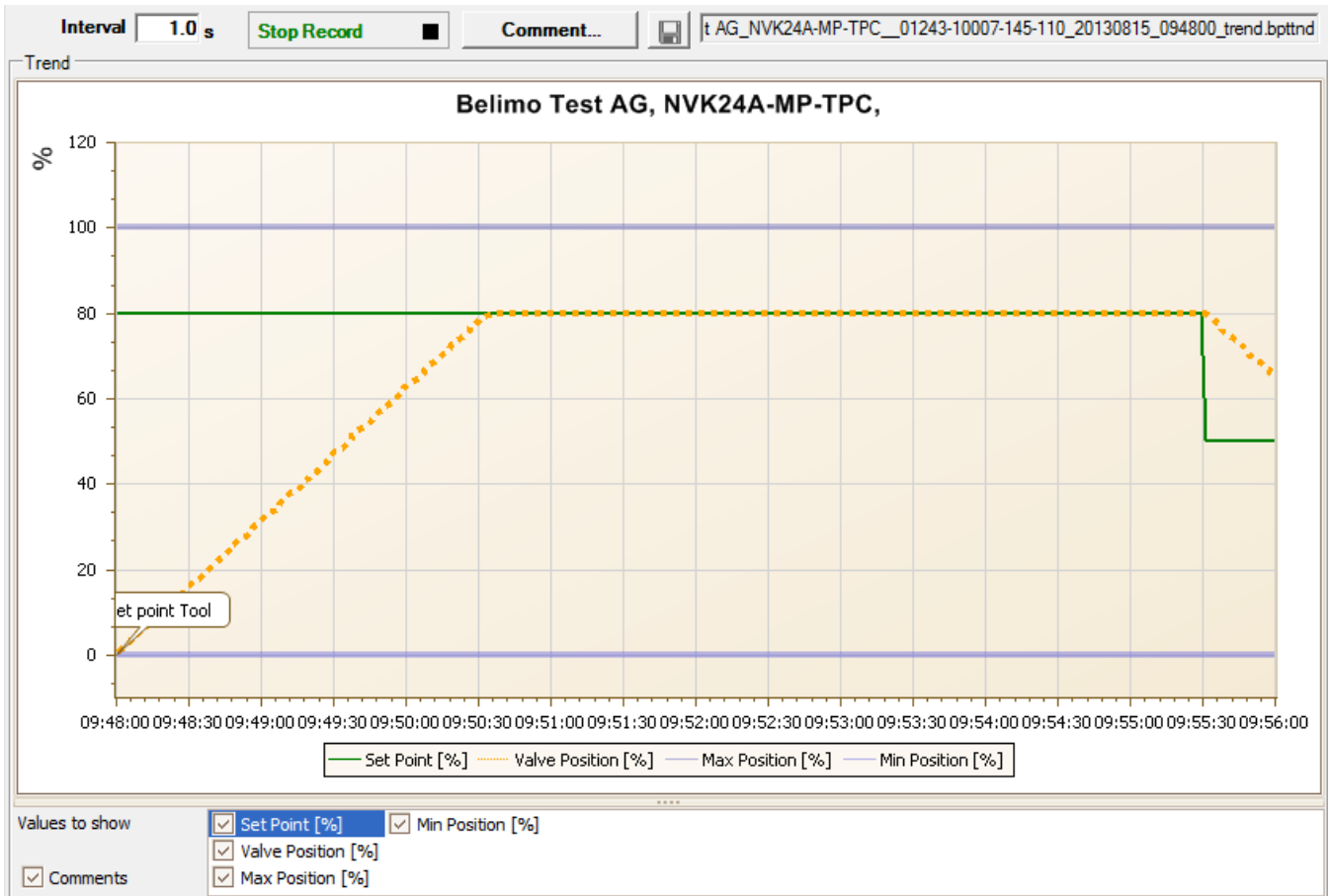

Trend plot

The Comment button allows you to enter a text at a defined time and the text is then saved in the trend file.

If you want to record a trend for more than one hour (long-term trend), enter a value of at least 2 seconds for the interval. If the interval is shorter, too many data points will result and the time for correcting the curve between the queries can become too short.

## 5 PC-Tool options

Select Tools▶PC-Tool options... in the main menu.

Variant Click the project in the outline bar [C] with the right mouse button and select PC-Tool options.

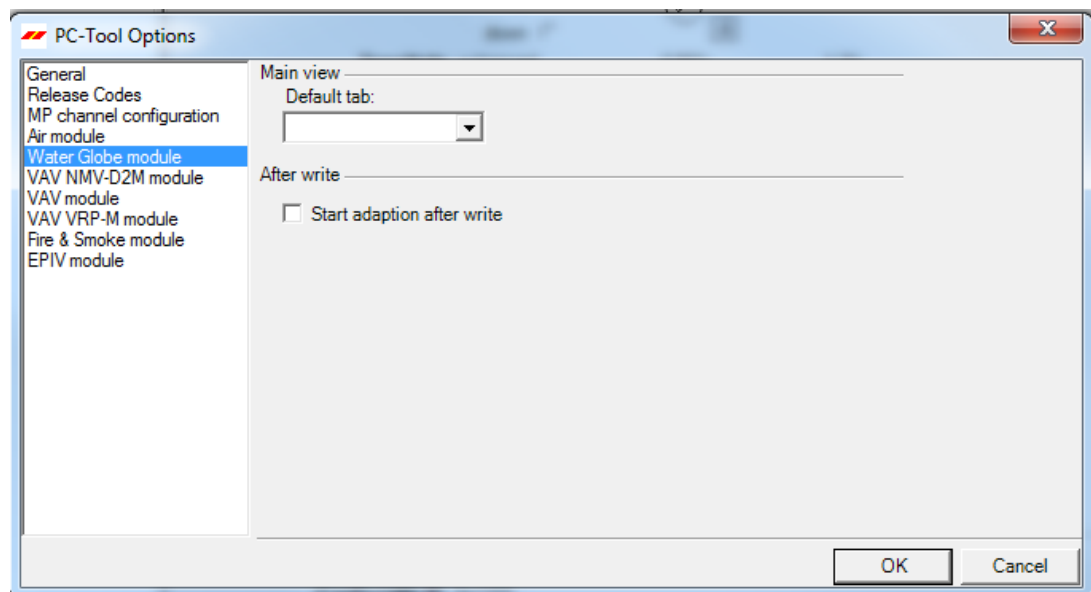

*Dialog for basic settings (Water Globe module)*

Select "Water/globe module" on the left.

Using the combobox "Default tab", you can select the index tab you want to open by default when starting the program PC-Tool.

If an adaptation is to be performed after every programming operation, select "Start adaption after write".

**PC-Tool V3.16 EPIV Module**  
**Electronic Pressure Independent Valve**  
**User Manual**  
**English**



# Table of Contents

1	Introduction.....	3
2	Service .....	4
2.1	Show Settings .....	4
2.2	Adaption.....	6
2.3	Synchronisation.....	6
2.4	Function Test .....	7
3	Configuration .....	9
3.1	Settings .....	10
4	Controller Simulation .....	13
4.1	Actuator Control (Actuator).....	14
4.2	Test.....	14
4.2.1	Test scripts .....	15
4.3	Reading out Sensors and Switches.....	16
4.4	Recording Trends.....	17
5	PC-Tool Options for EPIV Module .....	19

## 1 Introduction

The EPIV Module User Manual describes the detail area [D] of the module for the EPIV controller (Electronic Pressure Independent Valve, pressure-independent flow controller). The documentation is divided up in accordance with the tabs for "Service", "Configuration" and "Simulation".

---

**Note**



For function and wiring, see Product Information.

---

## 2 Service

### 2.1 Show Settings

The Service tab offers an overview of the current settings of the EPIV controller.

Type <b>SR24A-CF</b> SN <b>00444-30039-157-089</b> Designation <b>ePIV_01</b> Address <b>PP</b> Position		 
<b>Service</b>   <b>Configuration</b>   <b>Simulation</b>		
<b>Actual settings</b>		<input type="button" value="Test"/> <input type="button" value="Adaption"/> <input type="button" value="Synchronization"/>
Control mode Pos. Control Control signal Y DC 2-10 V  Sensitivity normal Feedback U5 Flow DC 2-10V Min: 0% Max: 100%		
U5-Characteristics U5 Characteristics on [equal percentage] Nominal range 96° adapted Valve Size DN 65 / 2½" V <sub>nom</sub> : 480 l/min Synchronization at Y=0%		
Bus fail position Last value Power ON No action Gear release button Synchronization		
<b>Actuator information</b>		
Firmware 01 V01.24-0005 Config table ID 0x10A9		
<b>Data log</b>		
Operating time 416h Active time 12h Stop & Go ratio 2%		
<b>Messages</b>		
Messages		<input type="button" value="Reset Messages"/>

Service tab for EPIV controller

In the general section of this user manual, a description is given as to how you can print out the control parameters [chapter 3.6.2.] or delete the maintenance and error messages [chapter 3.6.3].



Meaning of the settings

Control mode	Flow control or pos. control operation
Control signal Y	Type of control. If the control signal is interpreted as inverted, then this will be displayed.
Y-Characteristics	The EPIV controller works with either an equal-percentage or a linear characteristic curve. Characteristic curve off means "linear", characteristic curve on means "equal percentage".
Feedback U5	Type of feedback signal (conventional operation)
U5-Characteristics	Characteristic curve off means "linear", characteristic curve on means "equal percentage".
Nominal range	Nominal position range within the mechanical limits
Valve size	Size of the valve; is set by Belimo. If the specified volumetric flow scale with respect to the valve size has been changed from the factory setting, then the label marked "Scaling adjusted" will appear.
Volumetric flow settings	Operating volumetric flow settings: V'nom / V'max (only V'nom in open loop operation)
Synchronisation at	Stop position 0% or 100%
Bus fail position	Position in the event of MP communications failure
Power ON	Behaviour/Function when switching on the device or after a voltage interruption, respectively
Gear release button	Function when the gear release button is pressed
Firmware	Software version of the EPIV controller
Config table ID	Identification of the configuration table of the EPIV
Operating time	Number of hours during which the actuator was connected to the supply
Active time	Number of hours during which the actuator was mechanically moving and connected to the supply
Stop & Go ratio	Ratio of active time/operating time in percent. A high Stop & Go ratio (red) indicates that the control is unstable.

The following additional settings appear when EPIV is combined with Super Cap:

Power Fail-/Power off Pos.	Actuator position after failure of the supply voltage
Power fail Delay	Time after the failure of the supply voltage and before the actuator begins to move to the emergency setting position.
Power fail Count	Number of voltage interruptions

Converting units for volumetric flow

Select Tools ▶ PC-Tool Options in the main menu.

Click on "EPIV Module" at the left.

You can determine the physical units for the volumetric flow with the Combobox volume display

- l/min (litres per minute)
- m<sup>3</sup>/h (cubic metres per hour)
- l/s (litres per second)
- l/h (litres per hour)
- gpm (gallons per minute)

This setting applies for all displays, printouts, labels and writing into the log file [see general section of this user manual].

## 2.2 Adaption

With adaption, the actuator determines the available range 0% ... 100% by approaching the mechanical limits.

To start, click the "Adaption" button in the Service tab.

The progress of the adaption is displayed in the status bar. The actuator first moves against the programmed direction to the zero end stop and then to the end stop with complete valve opening.

The actuators can be configured in such a way that an adaption will be triggered automatically when the supply voltage is switched on.

## 2.3 Synchronisation

During synchronisation, one mechanical limit is approached in order to compare the position calculation.

Each actuator can be programmed to determine whether synchronisation is to be carried out at the zero end stop (0%) or with full valve opening (100%).

To start, click the "Synchronisation" button in the Service tab.

Variant You can also trigger the synchronisation directly at the actuator by pressing the gear release button.

The progress of the synchronisation is displayed in the status bar. If synchronisation at: is set to Y=0%, the actuator will move against the programmed direction to the zero end stop; if on the other hand synchronisation at: is set to Y=100%, then it will move to the end stop with full valve opening.

The actuators can be configured in such a way that a synchronisation will be triggered automatically when the plant is switched on.

## 2.4 Function Test

The opening and closing of the valve is checked during the function test.

The actuator first moves in accordance with the synchronisation position to the mechanical end stop. If the range is set to "adapted", then the other end stop will be approached; if it is set to "programmed", on the other hand, then it will move to the programmed range limit.

Click on the "Test" button in the Service tab. The normal display will then be covered over by the test window.

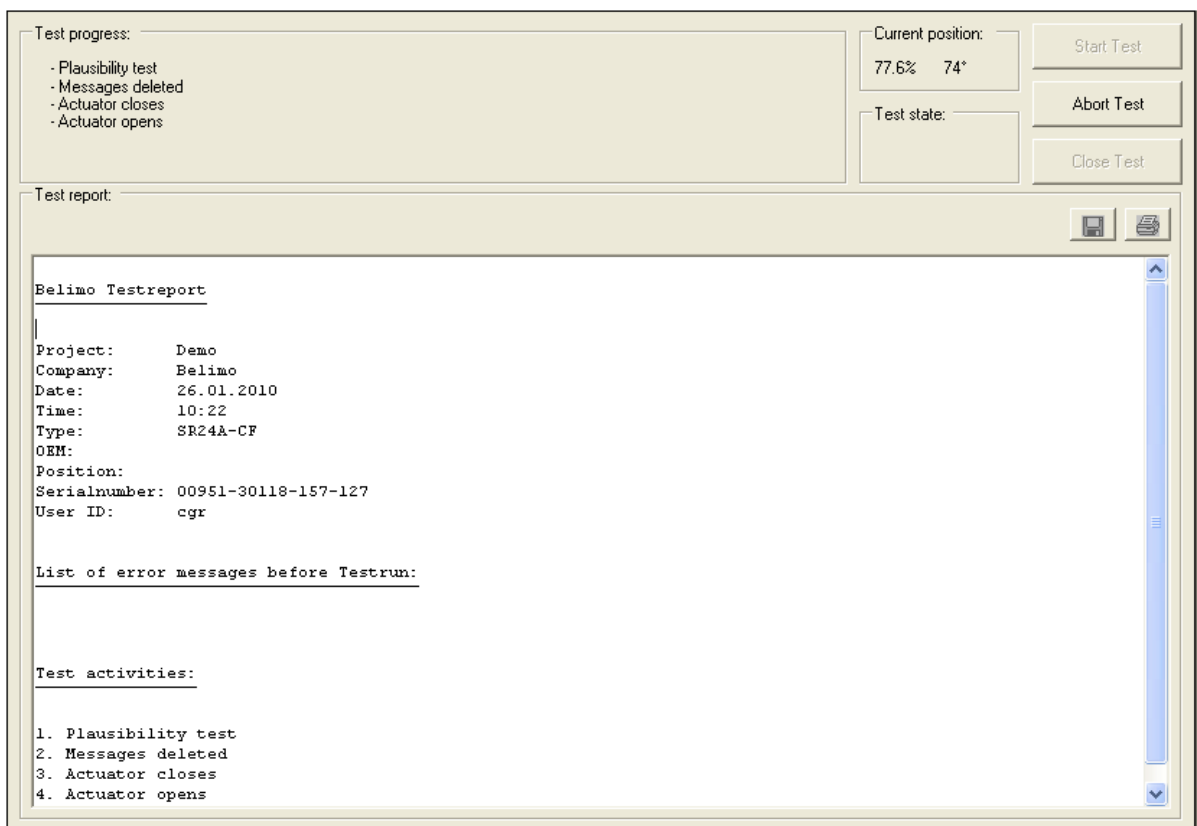

### *Display of test progress and test report*

Click on the "Start Test" button.

The progress and the current position will be displayed continuously.

The test report contains

- information concerning the project,
- the identification of the EPIV controller,
- a list of the error messages in effect before the start of the test,
- the test steps and the test result,
- the current controller settings.

---

If the test reports an invalid controller configuration, switch over to the "Configuration" tab after the test has been completed. There you will find the non-permitted values marked with a flashing exclamation mark.

---

You can save the test report as a file by clicking on the floppy disk symbol or print it out by pressing on the printer symbol.

End the function test by pressing on the "Close Test" button. The program will ask whether you would now like to save a test report that has not yet been saved.

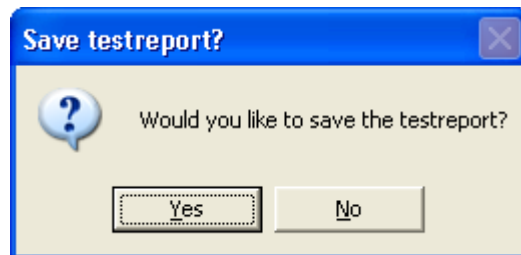

If you abort the test prematurely, then no test report will be compiled.

### 3 Configuration

In the "Configuration" tab, you can read out the parameter values from the EPIV controller, modify them and save them as a text file.

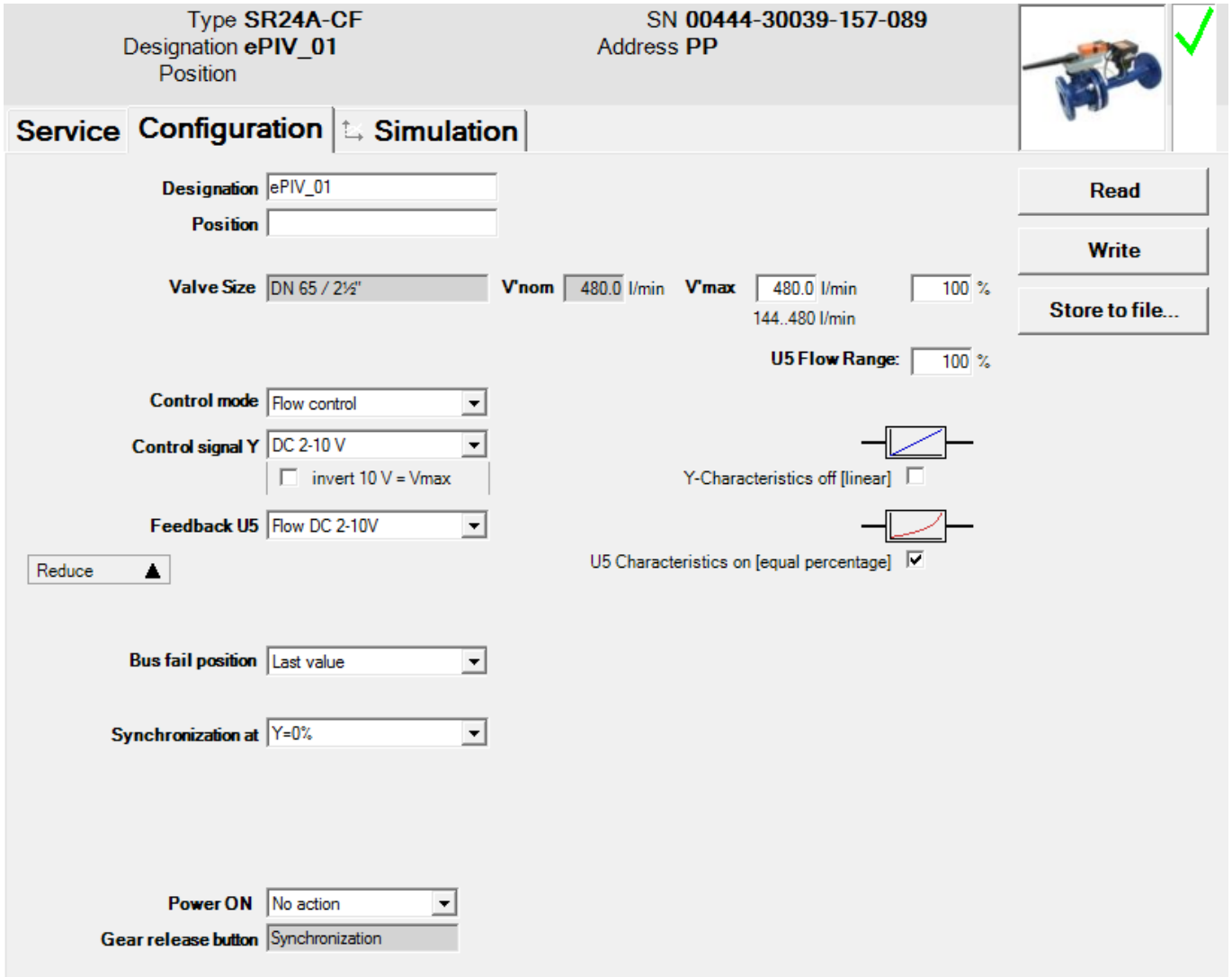

The screenshot displays the configuration interface for an EPIV controller. At the top, it shows the device type (SR24A-CF), designation (ePIV\_01), position, serial number (00444-30039-157-089), and address (PP). Below this, there are tabs for Service, Configuration (selected), and Simulation. The main configuration area includes fields for Designation, Position, Valve Size, V<sub>nom</sub>, V<sub>max</sub>, and U5 Flow Range. It also features dropdown menus for Control mode, Control signal Y, Feedback U5, Bus fail position, Synchronization at, and Power ON. A 'Gear release button' is set to Synchronization. On the right side, there are buttons for Read, Write, and Store to file..., along with a 'Reduce' button and a 'Y-Characteristics off [linear]' checkbox. Two graphs are shown: one for Y-Characteristics (linear) and one for U5 Characteristics (equal percentage).

"Configuration" tab for EPIV controller

The extended configuration in the lower area will become visible when you click on "Expand".

### 3.1 Settings

#### Controller ID<sup>1</sup>

Designation	16 characters of any text
Position	16 characters of any text

#### Valve size

Selection list with valve sizes	Sets the valve size and thus also the nominal volumetric flow specified by the manufacturer (default nominal volumetric flow, if a release code is available, can be modified. See below: "Display scaling").
---------------------------------	---

#### Volumetric flow, nominal

V'nom	Nominal volumetric flow (is set by the manufacturer)
-------	--

#### Volumetric flow range for the the control function "Flow control"

V'max	Upper limit of the operating volumetric flow setting (in selected unit or in %)  The possible range is displayed under the box, it lies between 30% - 100% of V'nom.
U5 volumetric flow range	Upper limit for the U5 volumetric flow range. This value is typically the same as V'max[%].  The value only has an influence on the U5 feedback voltage value.

You can change the physical units for the volumetric flow in "Tools ▶ PC-Tool Options" in the main menu [see chapter 2.2.].

An existing value for U5 volumetric flow range will automatically adjust itself to the V'max when the latter is entered. On the other hand, the V'max will not change if you change the U5 volumetric flow range yourself.

#### Control mode

Flow control	Pressure independant operation
Pos. control (Open Loop)	Pressure dependant operation

#### Control signal Y

DC 0.5 ... 10V	Fixed operating range 0.5 ... 10V
DC 2 ... 10V	Fixed operating range 2 ... 10V
DC variable	Start (Y=0%) 0.5 ... 8V Stop (Y=100%) 2.0 ... 32V

<sup>1</sup> Only characters from the Western European character set are permitted to be used for designation and position (see general section, table chap. 4.3.3).

	Range between start and stop at least 2V
--	--

Control signal Y inverted

on	Inverts the control signal Y (lowest voltage = V'max)
off	Control signal Y normal (highest voltage = V'max)

Feedback U5 (active only if actuator address is set to PP)

Volumetric flow 0.5 ... 10V	Volumetric flow feedback 0 ... 100%, V'nom = 0.5 ... 10V
Volumetric flow 2 ... 10V	Volumetric flow feedback 0 ... 100%, V'nom = 2 ... 10V
Volumetric flow variable	Volumetric flow feedback 0 ... 100%, V'nom Start 0.5 ... 8.0 volt / stop 2.0 ... 10.0V Range between start and stop at least 2V
Valve position 0.5 ... 10V	feedback Valve position 0 ... 100%, Nominal range = 0.5 ... 10V
Valve position 2 ... 10V	feedback Valve position 0 ... 100%, Nominal range = 2 ... 10V
Valve position variable	feedback Valve position 0 ... 100%, Bereich Start 0.5 ... 8.0 Volt / Stop 2.0 ... 10.0 V Nominal range between start and stop at least 2V

Y-Characteristic curve

on	Characteristic curves for control function Y switched on (input signal to volume equal percentage)
off	Characteristic curves off (input signal to volume linear)

U5 Characteristic curve

on	Characteristic curves for feedback U5 switched on (input signal to volume equal percentage)
off	Characteristic curves off (input signal to volume linear)

Bus fail position

Last setpoint	Volumetric flow in accordance with the last setpoint of the MP master received
Open	Open valve (100%, valve completely open)
Close	Close valve
Max / V'max	V'max volumetric flow

Sensitivity (only with "Open Loop" control function)

normal	Normal reaction sensitivity and inversion hysteresis (values are dependent on actuator type)
--------	--

reduced	Reduced reaction sensitivity and increased inversion hysteresis (values are dependent on actuator type)
---------	---

Synchronisation at

Y = 0%	Approaching the mechanical limit with zero end stop (valve closed)
Y = 100%	Approaching the mechanical limit with full valve opening

With Power ON

Adaption	Approaching both mechanical limits and recalculation of angle-dependent parameters
Synchronisation	Approaching one mechanical limit (in accordance with the setting "Synchronisation at")
No action	

Gear release button

Synchronisation	(preset for EPIV actuators)
-----------------	-----------------------------



## 4 Controller Simulation

Switch over to the "Simulation" tab.

Type **SR24A-CF**  
Designation **ePIV\_01**  
Position

SN **00444-30039-157-089**  
Address **PP**

**Service**

**Configuration**

**Simulation**

<b>Actuator</b>	<input type="radio"/> Simulation off	<input type="radio"/> Close	<b>Set point</b>	<b>Actual flow</b>	<b>Valve</b>
	<input type="radio"/> Set point Y	<input type="radio"/> V <sub>nom</sub>	<input type="text" value="40 %"/>	<input type="text" value="24 %"/>	<input type="text" value="13 %"/>
	<input checked="" type="radio"/> Set point Tool	<input type="radio"/> V <sub>max</sub>		<input type="text" value="113 l/min"/>	<input type="text" value="13 ° ↙"/>
	<input type="radio"/> Motor stop		<input type="text" value="5.2 V"/>	<input type="text" value="6.4 V"/>	
	<input type="radio"/> Open				

Test ▶ Testfile Test\_EPIV\_Max 3m.bptts

Interval  Stop Record  Comment...  mo Test AG\_SR24A-CF\_\_00444-30039-157-089\_20130814\_173715\_trend.bpttnd

Trend

**Belimo Test AG, SR24A-CF,**

Set Point [%]     Actual Volumetric Flow [l/min]     Valve Position [%]

Values to show

<input checked="" type="checkbox"/> Set Point [%]	<input type="checkbox"/> Actual Voltage [V]
<input checked="" type="checkbox"/> Actual Volumetric Flow [l/min]	<input type="checkbox"/> Set Voltage [V]
<input checked="" type="checkbox"/> Valve Position [%]	

Comments

"Simulation" tab for VAV controllers

---

Control simulation will be influenced if the actuator is currently carrying out an adaption or a synchronisation. The "Motor Stop" function overrides any ongoing adaption or synchronisation.

---

## 4.1 Actuator Control (Actuator)

Use the radio buttons to select the setpoint specification.

- Setpoint Y: Control function at connection Y.
- Setpoint tool: Input of the setpoint in % of the volumetric flow (100% corresponds to  $V'max$ ), as volumetric flow value (e.g. l/min) or as control function (volts).

Clicking on "Motor Stop" stops the actuator.

The following override steps can be specified per radio button.

- Open: Valve completely opened
- Close: Valve completely closed
- $V'nom$ : Nominal volumetric flow
- $V'max$ : Volumetric flow  $V'max$  (100%)

### Measured values

The following are displayed:

- The current volumetric flow 0 ... 100% of the  $V'nom$
- The actual flow of the volumetric flow in l/min or the selected unit
- The feedback voltage in volt (U5 signal)
- The valve opening in %
- The current angle of rotation in angular degrees
- An active override step is displayed as text, independently of whether it was specified by the PC-Tool or externally (control function Y)
- Fault indication of flow sensor: Following messages will be displayed in case of malfunction flow measurement:
  - a) "Sensor not ok": Flow sensor is defect or not connected
  - b) "Air bubbles": The medium contains air bubbles that disturbs the measurement.

## 4.2 Test

The test function is available for the structured testing of the EPIV actuator.

A number of commands which follow one another in sequence [see 4.2.1] are defined in a test script file. A trend record is triggered at the start of the function.

### Select test file

Select the desired scrip with the Combobox test file. Only test scripts for EPIV modules are displayed in the Combobox.

### Start test script

Click on the test ▶ button. The tests will begin at once.

### Create test script

In accordance with the templates, users can also create test scripts of their own. File name must contain the character block "EPIV".

#### 4.2.1 Test scripts

The following test scripts are available as templates.

Name of the test file	Functions
Test_EPIV_Max 3m.bptts	V'max – 3 minutes
Test_EPIV_Max-Auto-Min 9m.bptts	V'max – 3 minutes Auto – 3 minutes V'min – 3 minutes

### 4.3 Reading out Sensors and Switches

The values from the integrated sensors and switches can be read out in MP mode. This function must however be activated in advance under "General" in the PC-Tool Options. Select Tools ▶ PC-Tool Options in the main menu.

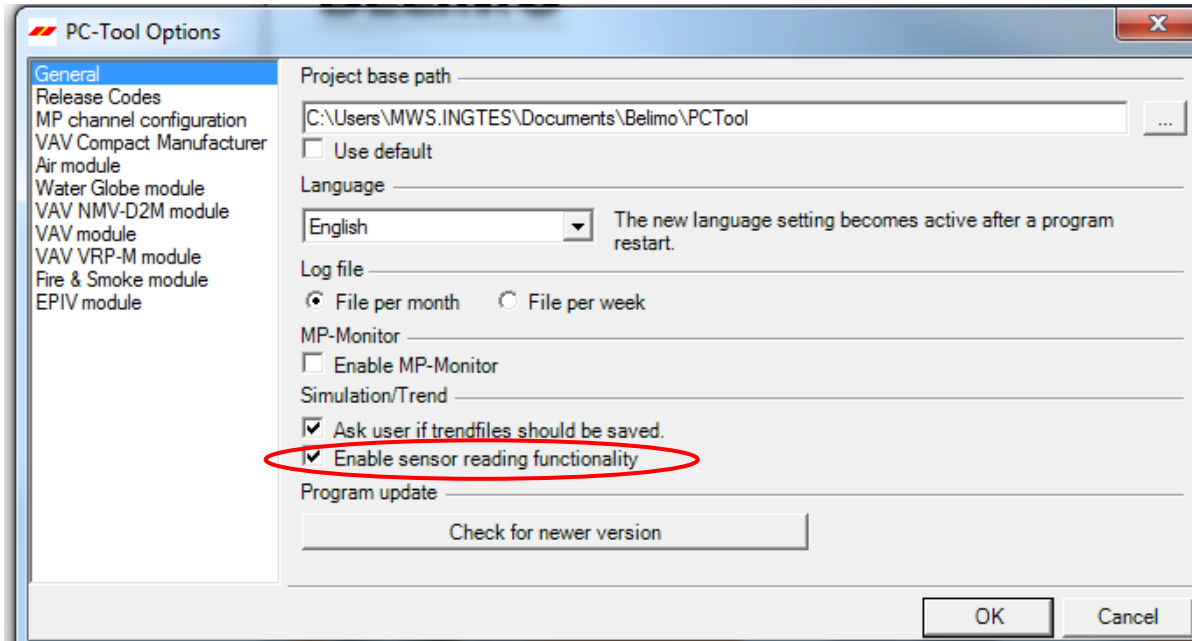

Settings for reading out sensors

A region with the sensor values will be shown on the Simulation tab, to the right next to the actuator control.

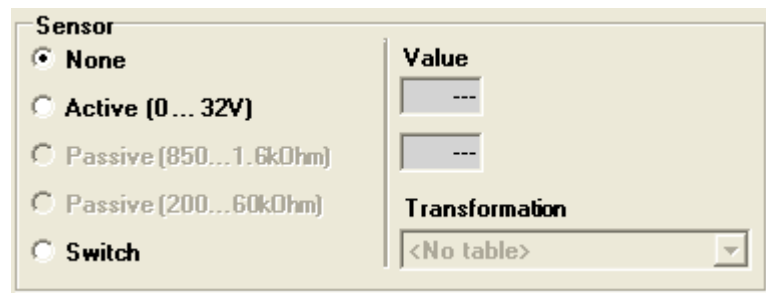

Sensor display in MP mode

Use the radio buttons to select the type of the connected sensor. The value is displayed accordingly in either volts (active), ohm (passive) or as on/off (switch).

The raw value of the sensor can still be converted into the corresponding measured variable (temperature, etc.) with the help of the transformation table (see chapter "Transformation table" from the general user manual).

### 4.4 Recording Trends

The progression over time of the setpoint and actual values can be displayed in a diagram during the simulation. The values are saved to a trend file and can be displayed again at a later date. In addition, commentary texts of one's choosing can be added.



On trend record, the trend is automatically saved to a temporary file and retained for one month. Click on the icon "Save" to save the trend with a different name and location (after stop record).

In the PC tool options "General" specify whether the program should ask for the new file name (ask user if trend files should be saved). The suggested file name can be modified before saving the file.



During the simulation, click on the "Trend Record" button. The display changes to a "flat" button. Clicking once more will interrupt the recording.

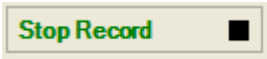

According to the presettings, measured values are queried at one-second intervals. You can change the querying interval in the interval input box. The permitted values range from 0 to 9999 seconds, for which the value "0" means "no waiting time" (querying as rapidly as possible).

If you wish to record a trend for more than one hour (long-term trend), enter a value of at least 2 seconds for the interval. Shorter intervals cause too many data points to be created and the time for plotting the curve between the queries could become too short.

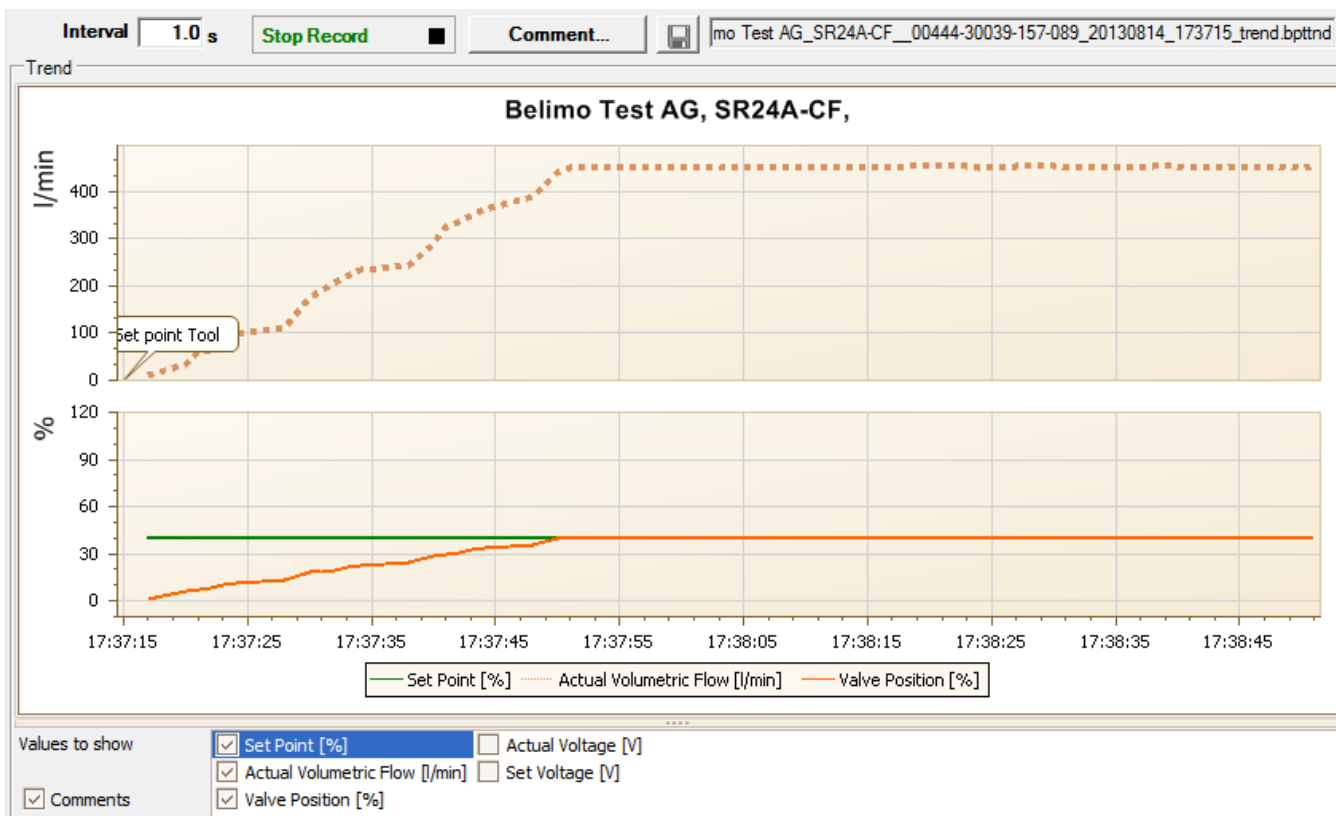

Trend diagram for the control function "Flow control"

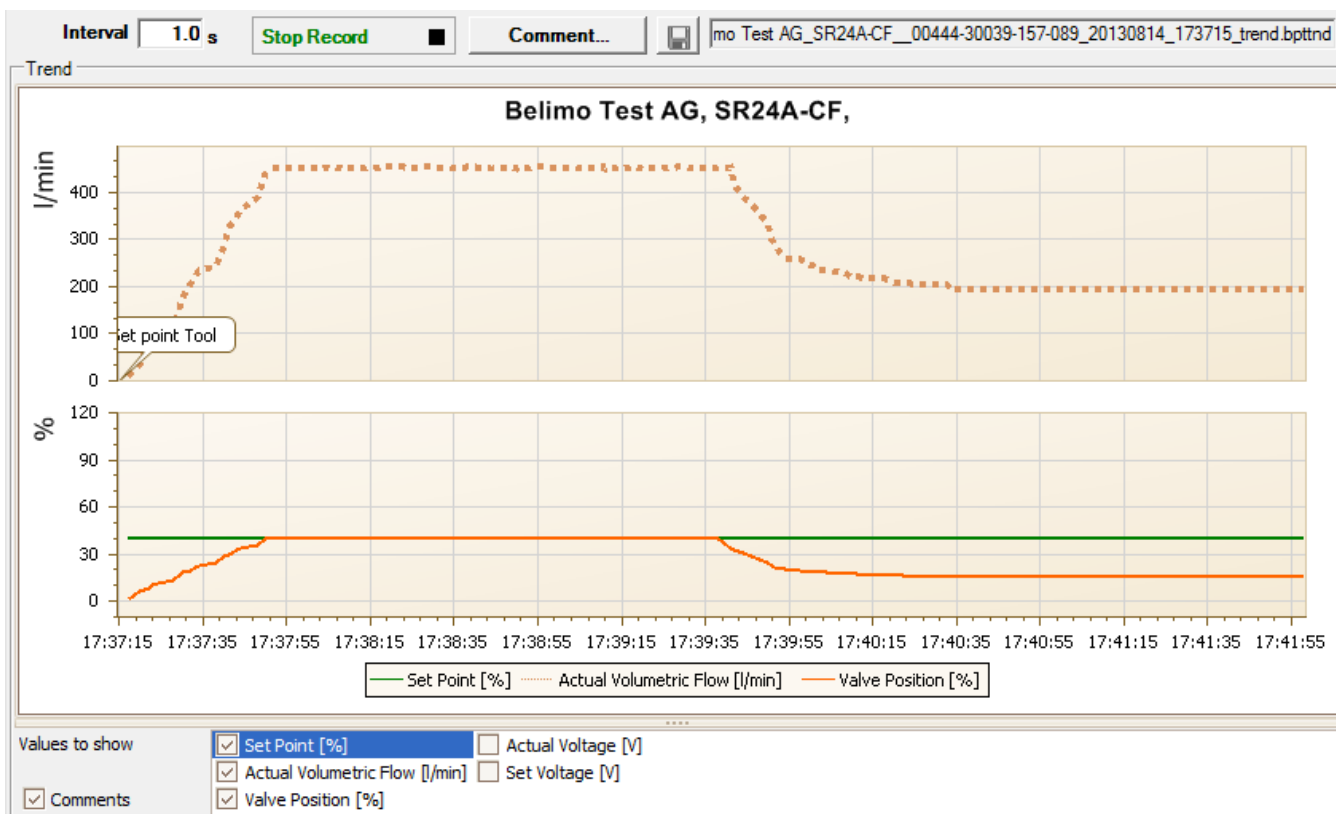

Trend diagram for the control function "Open loop"

You can use the comment button to enter a text at a defined point in time, which is then saved in the trend file.

## 5 PC-Tool Options for EPIV Module

Select Tools ► PC-Tool Options in the main menu.

Variant Right-hand mouse click on the program symbol in the overview bar and select PC-Tool Options.

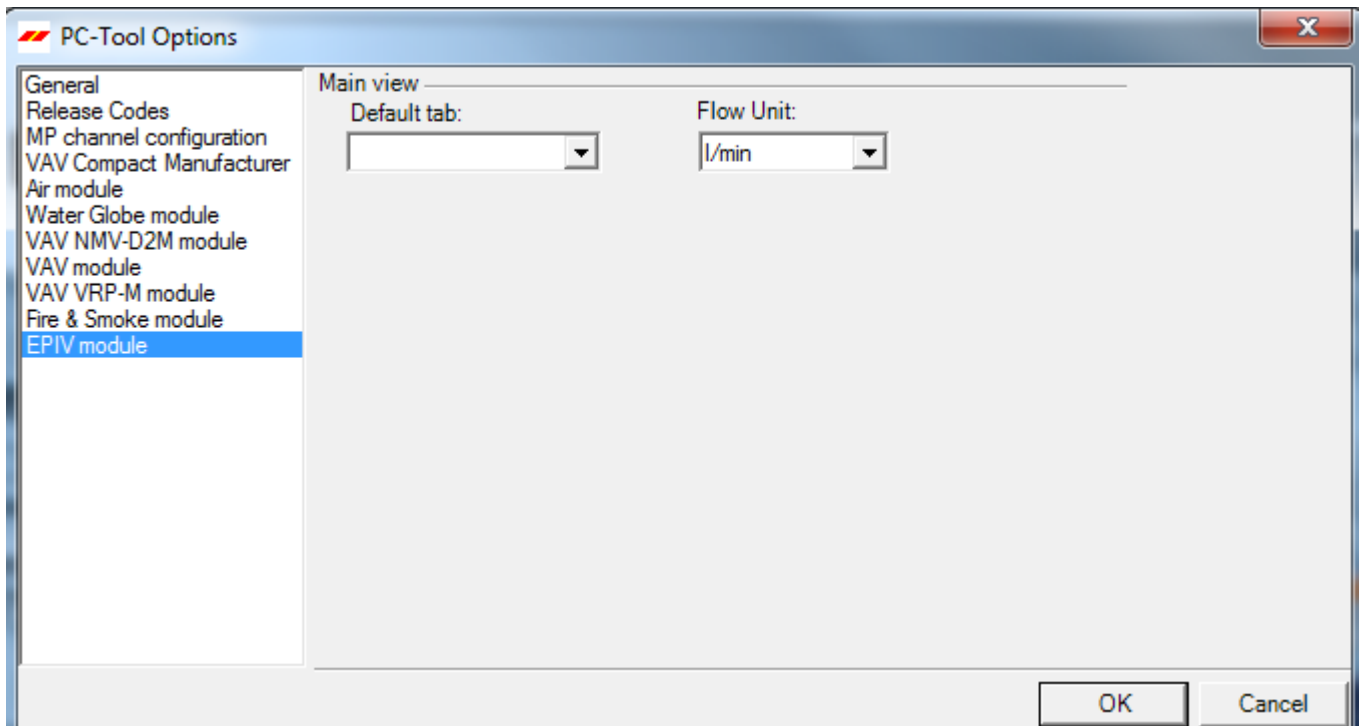

*Dialogue for basic settings (EPIV Module)*

Click on "EPIV Module" at the left.

### Main window

In accordance with the most frequent usage, use the "Default Register" Combobox to determine which tab is to be opened in the default settings when the program is started up.

You can select the physical units for the volumetric flow with the Combobox volume display

- l/min (litres per minute)
- m<sup>3</sup>/h (cubic metres per hour)
- l/s (litres per second)
- l/h (litres per hour)
- gpm (gallons per minute)

**PC-Tool V3.x VAV NMV-D2M module**  
**For VAV controller**  
**User Manual**  
**English**





# 1 Actuators for VAV controllers NMV-D2M

The current program version of PC-Tool V3.x does not support this type of actuator. If you have installed the previous version (PC-Tool 2.1), you can use this instead.

**This device is not supported by the current version of PCTool. You can use PC-Tool V2.1 to work with this device.**

**Run PC-Tool V2.1**

In order to run PC-Tool V2.1 the current channel to the MP-bus has to be closed.  
To continue working with this version of PC-Tool:  
1) Close external tool  
2) Choose 'Open' in the context menu of the channel in the tree

### Switch-over option for non-supported actuators

To enter the storage location of the program PC-Tool V2.1, select Tools ► PC-Tool options in the main menu. Mark the NMV-D2M module.

Variant Click the project in the outline bar [C] with the right mouse button and select PC-Tool options.

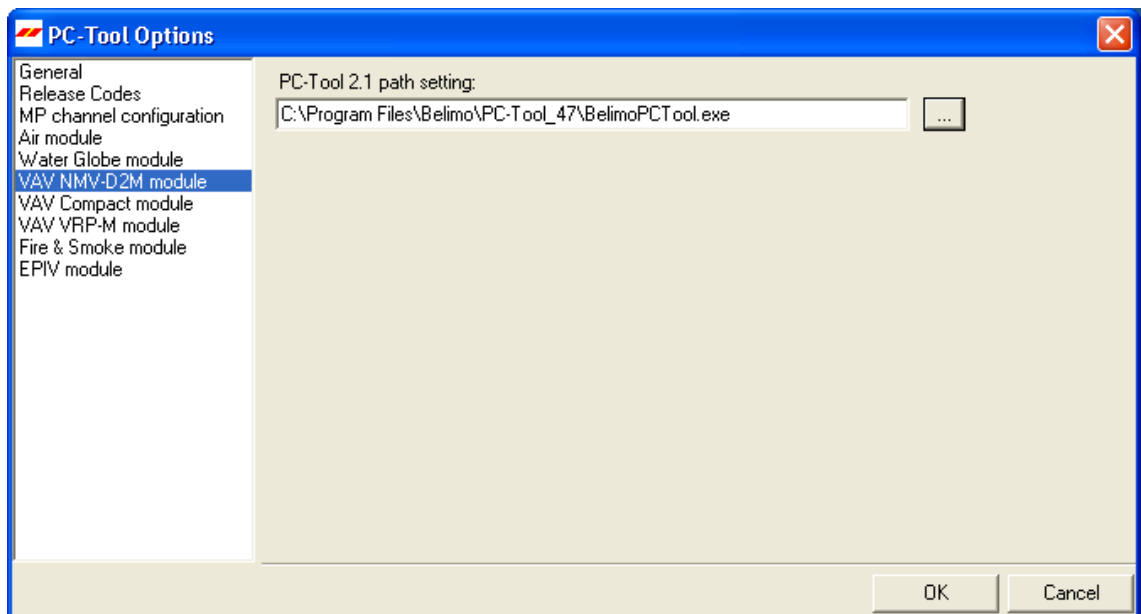

PC-Tool settings for VAV NMV-D2M module

If you have stored the start path for PC-Tool V2.1 in the options, the tool starts automatically as soon as a VAV NVM-D2M actuator is connected. To work with PC-Tool V3.x again, you need to disconnect the connection to the drive.

**PC-Tool V3.x VAV VRP-M module**  
**For VAV controller**  
**User Manual**  
**English**



# 1 Actuators for VAV controllers VRP-M

The current version of the program (PC-Tool 3.x) does not support this type of actuator. If you have installed the VRP-M, you can use this instead.

**The VRP-M controller is not supported by the PC-Tool V3.x. You can start now the VRP-M Tool to work with this device.**

The MP-Strang gets closed during the start from the VRP-M Tool.

To continue PC-Tool V3.x:  
 1) close the VRP-M Tool  
 2) 'open' the MP-Strang (A right on the MP-Channel icon opens the menu).

### Switch-over option for non-supported actuators

To enter the storage location of the VRP-M tool, select Tools ▶ Options in the main menu. Mark the VAV VRP-M module.

Variant Click the project in the outline bar [C] with the right mouse button and select PC-Tool options.

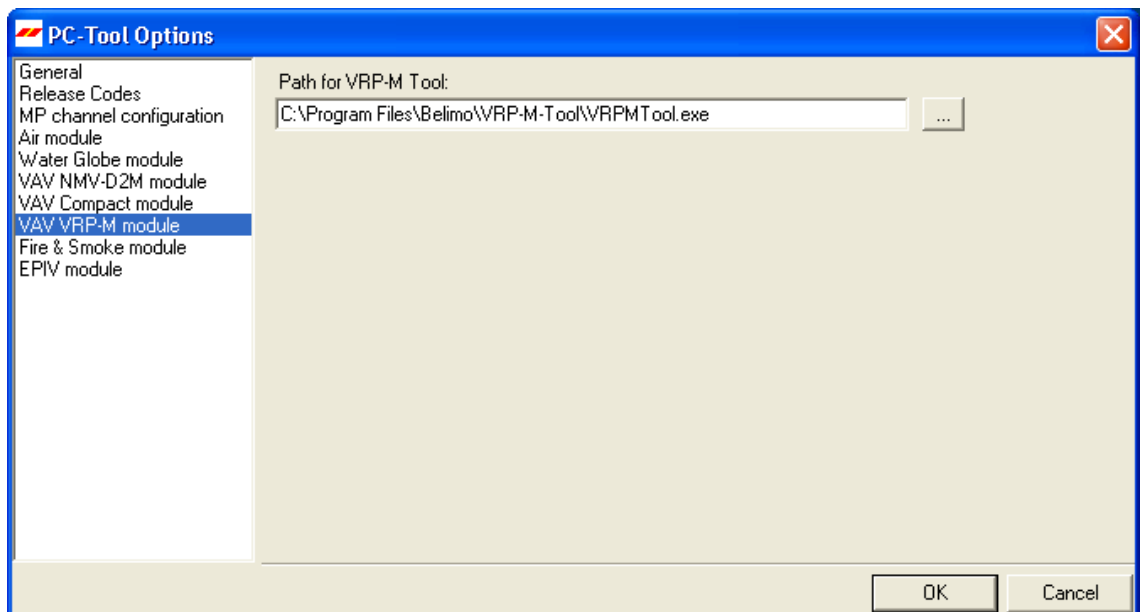

PC-Tool settings for VAV VRP-M module

---

To prevent a conflict from occurring at the serial interface of the computer, the MP-Channel is closed during the switch-over.

You have to open the MP-Channel again if you want to continue working with PC-Tool 3.x. To do this, click the right mouse button on the MP-Channel in the overview bar and select Open in the pop-up menu.

---

# PC-Tool V3.16 MPL-Module

## User Manual

### English

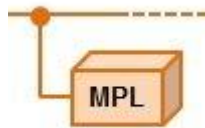

## Table of contents

1	Introduction.....	3
2	Service .....	4
2.1	Shows settings and provides a simple Simulation .....	4
2.2	Adaptation .....	5
2.3	Synchronization.....	5
2.4	Control of the actuator (Simulation) .....	5

## 1 Introduction

The User Manual of MPL-Module describes the detail area [D] of the MPL module. The documentation describes the only available tab "service".

This module handles all Belimo manufactured MPL actuators.

## 2 Service

### 2.1 Shows settings and provides a simple Simulation

The Service tab offers an overview of the current settings of the actuator as well as a simple possibility to enter a set point and check the actual position (simulation).

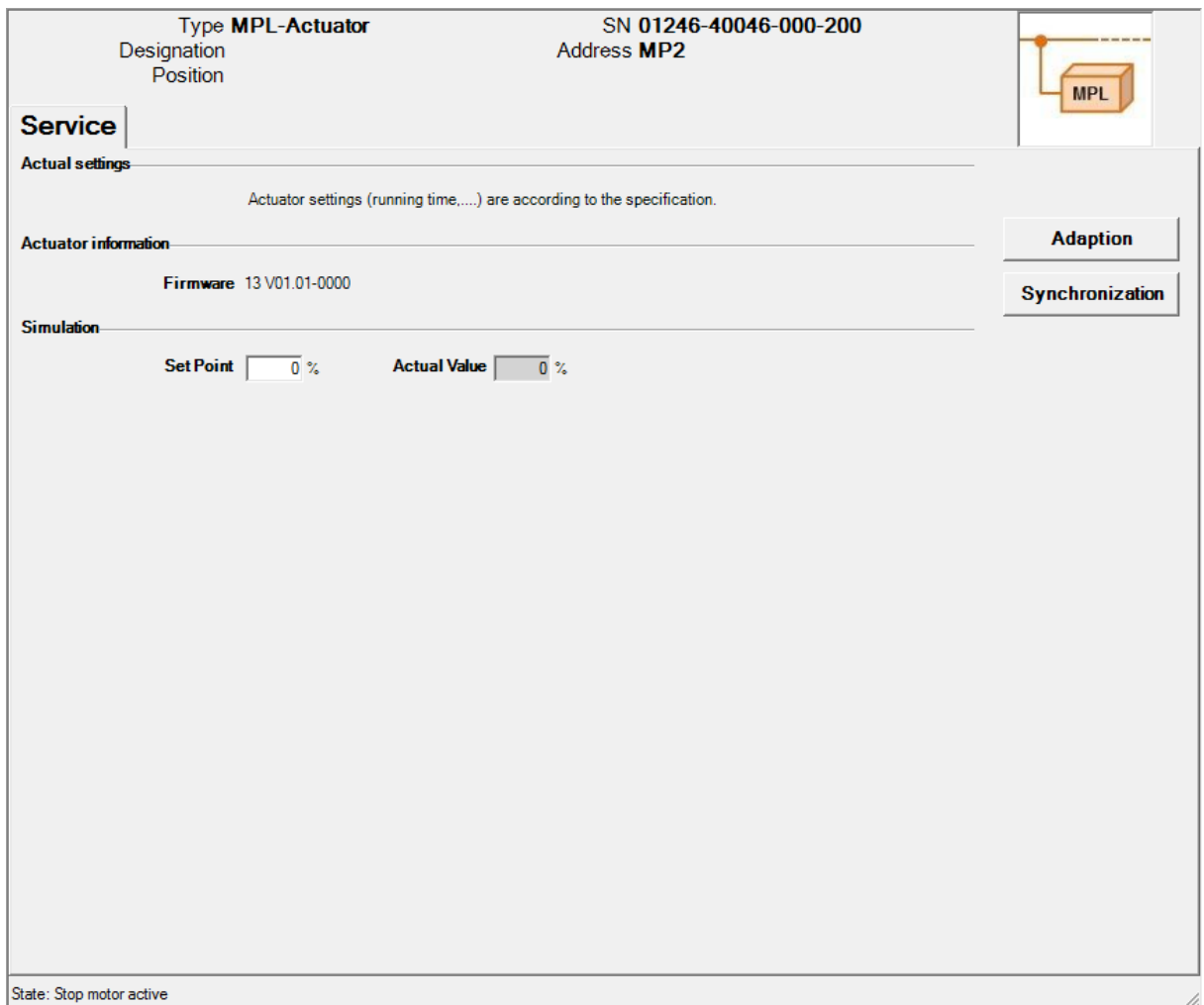

Service tab for MPL-Module

#### Meaning of the settings

Actual settings	Actual settings (running time...) of a specific MPL actuator can be taken from the specification sheet.
Firmware	Actual version of the software in the MPL actuator.
Set Point	Field to enter a Set Point in percent of the actual working range (programmed range). 0% means Minimum, 100% means Maximum.
Actual Value	Shows the actual position of the actuator.

## 2.2 Adaptation

In the adaptation, the actuator determines the range 0% ... 100% by approaching the mechanical limits (end stops).

Click the "Adaption" button on the Service tab to execute an adaptation.

The progress of the adaptation is displayed in the status line. The actuator moves consecutively to both mechanical end stops.

Variant You can also trigger the adaptation directly on the actuator.

## 2.3 Synchronization

In the case of synchronization, the actuator moves only to **one** mechanical end stop in order to calibrate the origin.

Click the "Synchronization" button on the Service tab to start the synchronization process.

## 2.4 Control of the actuator (Simulation)

Set Point Tool: Enter the Set Point in percent of the programmed (or adapted) operating range. 0% means minimum, 100% means maximum.

Actual Value: Shows the actual angle of rotation or stroke position during simulation process in percent of the programmed (or adapted) operating range.



# PC-Tool V3.16 CM VAV-Modul

## User Manual

### English



# Table of Contents

1	Introduction.....	3
2	Service .....	4
2.1	Displaying settings .....	4
2.2	Convert units for volumetric flow.....	6
2.3	Synchronisation.....	6
3	Configuration .....	7
3.1	Settings .....	8
4	Controller simulation .....	9
4.1	Actuator control .....	9
4.2	Test .....	10
4.2.1	Test scripts .....	11
4.3	Reading out sensors and switches .....	11
4.4	Trend recording .....	13
5	PC-Tool options.....	14

## 1 Introduction

The CM VAV module user manual describes the detail area [D] of the module for CM VAV controllers. The documentation is divided according to the three index tabs "Service", "Configuration" and "Simulation".

---

**Note**

For function and wiring, see CM-VAV product information

---

## 2 Service

### 2.1 Displaying settings

The Service tab gives an overview of the current settings of the CM-VAV controller.

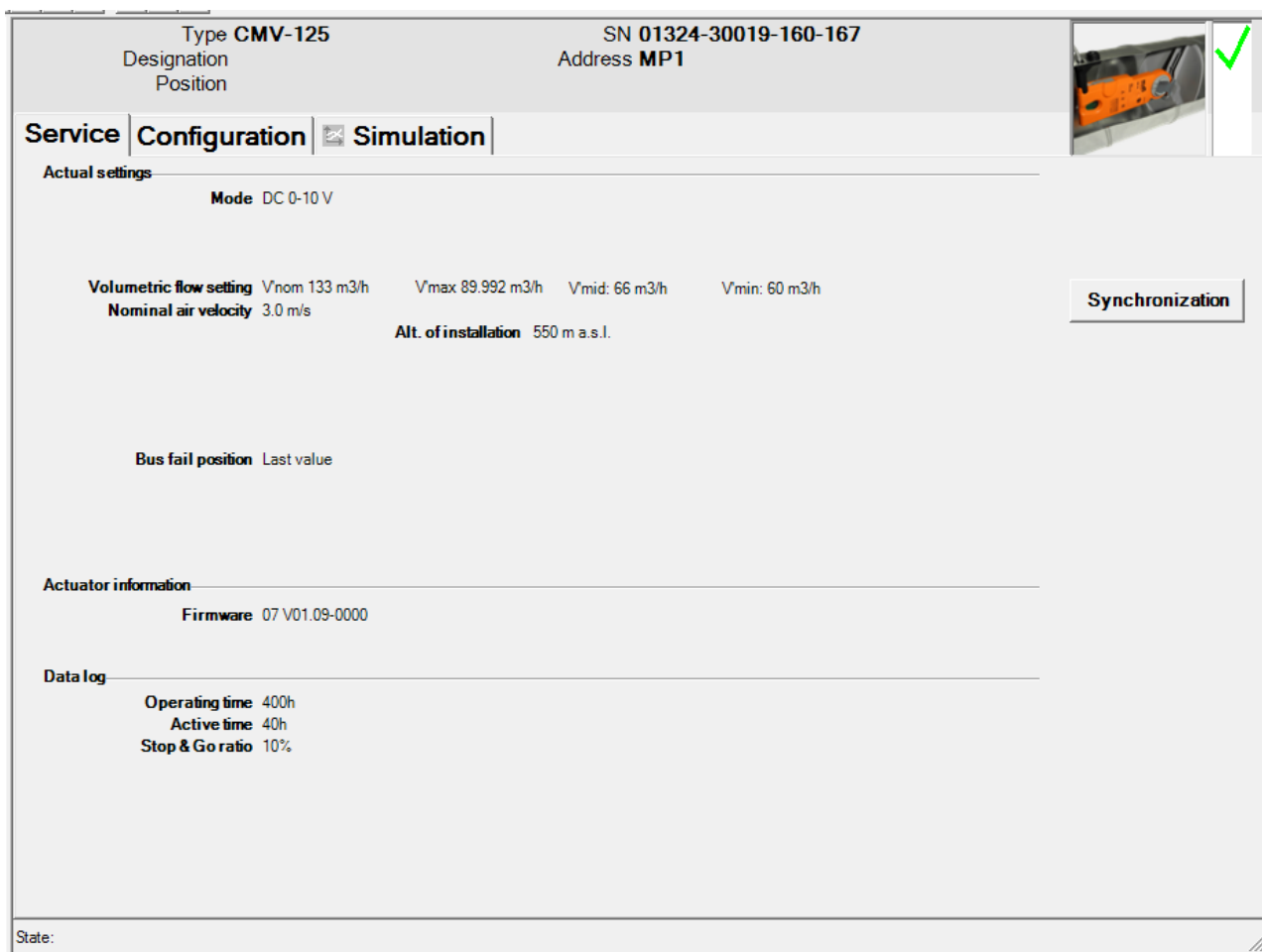

#### Register Service

The general part of this manual describes how you can print out the controller parameters [Section 3.6.2.].

Meaning of the settings

Control signal Y	Type of control
Volumetric flow settings	Operating volumetric flow settings: V'nom / V'max / V'min / V'mid (only V'nom in open loop operation)
Nominal air velocity	Air velocity when air flow is equal to V'nom
Behavior in the event of bus failure	Behavior in the event of a communication failure
Firmware	Software version of the CM-VAV.
Operating time	Number of hours during which the actuator was connected to the power supply
Active time	Number of hours during which the actuator was mechanically in motion and connected to the power supply
Stop & Go ratio	Ratio of active time/operating time in percent. A high Stop & Go ratio indicates unstable control

## 2.2 Convert units for volumetric flow

The same settings as to VAV Compact apply to the CM VAV module.

Select Tools ► PC-Tool options... in the main menu.

Click the "VAV- module" on the left.

With the Volume display combobox, you determine the physical units for the volumetric flow

- m<sup>3</sup>/h (cubic meters per hour)
- l/s (liters per second)
- cfm (cubic feet per minute).

This setting is for all displays, printouts, labels and writing to the log file [see General part of this manual].

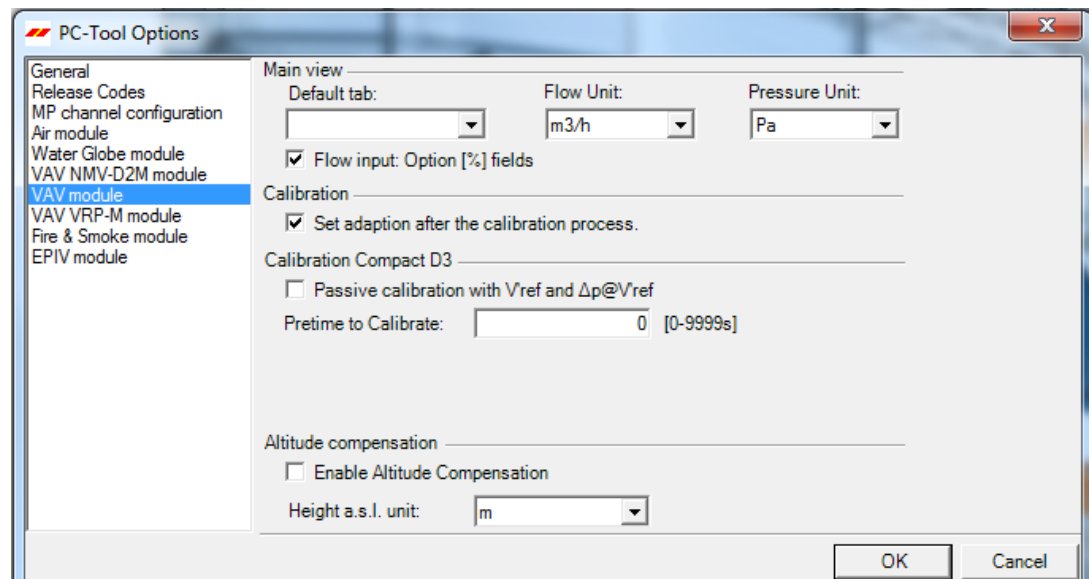

## 2.3 Synchronisation

In the case of synchronization, a mechanical limit is approached in order to calibrate the position calculation.

To start, click the "Synchronization" button on the Service tab.

The progress of the synchronization is displayed in the status line.

### 3 Configuration

In the "Configuration" box, parameter values can be read out from the VAV-Compact controller, changed and stored in a text file. The valid ranges for the parameter values are displayed in parentheses next to the input boxes.

Type **CMV-125**  
Designation  
Position

SN **01324-30019-160-167**  
Address **PP**



**Service**

**Configuration**

Simulation

Designation

Position

Volume flow

<b>V<sub>nom</sub></b>	133 m <sup>3</sup> /h				<b>Nominal air velocity</b>	<input type="text" value="3"/> m/s
<b>V<sub>max</sub></b>	<input type="text" value="90"/> m <sup>3</sup> /h	60..132 m <sup>3</sup> /h	<input type="text" value="68"/> %		<b>Alt. of installation</b>	<input type="text" value="550"/> m a.s.l. 0..3000
<b>V<sub>mid</sub></b>	<input type="text" value="66"/> m <sup>3</sup> /h	60..89 m <sup>3</sup> /h	<input type="text" value="50"/> %			
<b>V<sub>min</sub></b>	<input type="text" value="60"/> m <sup>3</sup> /h	0..89 m <sup>3</sup> /h	<input type="text" value="45"/> %			

**Read**

**Write**

**Store to file...**

**Mode**  0..10 V  2..10 V

**Feedback U5**

**Reduce**

**Bus fail position**

State: Stop motor active

"Configuration" tab

The extended input boxes in the bottom area become visible when you click "Expand".

7 / 15

### 3.1 Settings

#### Controller identifier<sup>1</sup>

Designation	16 characters of any text
Position	16 characters of any text

#### Volumetric flow, nominal

V'nom	Nominal volumetric flow (read only value)
Nominal air velocity	Air velocity when air flow is equal to V'nom

#### Volumetric flow range during operation

V'min	Lower limit of operating volumetric flow setting
V'mid	CAV level between V'min and V'max
V'max	Upper limit of operating volumetric flow setting

You can convert the physical units for the volumetric flow via Tools ► PC-Tool options in the main menu [see Section 2.2.].

In the options, you can also define whether the input of the volumetric flow for V'min and V'max in percent is possible.

An existing value for V'mid is automatically adapted when V'min and V'Max are entered: If you enter V'min, V'mid is always larger than or equal to this input value. If you enter V'max on the other hand, V'mid is always less than or equal to this value.

#### Mode (positioning signal Y / feedback U5)

0 ... 10 V	Sets positioning signal Y = 0 ... 10 V, feedback U5 = volumetric flow, 0 ... 10 V
2 ... 10 V	Sets positioning signal Y = 2 ... 10 V, feedback U5 = volumetric flow, 2 ... 10 V

#### Behavior in the event of bus failure

Last setpoint	Volumetric flow according to the last received setpoint from the MP master
Open	Move to full angle of rotation/stroke (100%)
Close	Move to zero stop
Min / V'min	V'min volume
Max / V'max	V'max volume

<sup>1</sup> Only characters from the Western European character set are permitted for "Description" and "Position" (see General part, table in Section 4.3.3).



## 4 Controller simulation

Go to the "Simulation" tab.

"Simulation" tab

The controller simulation is influenced when the actuator is currently carrying out a synchronization. The function "Motor stop" overrides a running adaption or synchronization.

### 4.1 Actuator control

Select the type of setpoint definition with the radio buttons.

- Setpoint Y: Positioning signal at the connection Y.
- Setpoint Tool: The setpoint is entered in % of the volumetric flow (0% corresponds to V'min, 100% V'max).

The control is switched off when you click Motor stop.

The following overrides can be specified via radio button.

- OPEN: Damper completely opened
- CLOSED: Damper completely closed
- V'nom: Nominal volumetric flow
- V'min: Volumetric flow V'min (0%)

- V'max: Volumetric flow V'max (100%)
- V'mid: CAV volumetric flow V'mid

#### Measurement values

The following are displayed:

- The setpoint in V or percent or m<sup>3</sup>/h, l/s or cfm
- The actual volumetric flow in 0 ... 100% of V'nom
- The actual volumetric flow in m<sup>3</sup>/h, l/s or cfm
- The feedback voltage in V (U5 signal)
- Actual air velocity [m/s]
- Actual air temperature in the duct [°C]
- The damper opening in %
- An active override is displayed as text, independent of whether they were specified by the PC-Tool or externally (positioning signal Y).

The trend lines can be fade in or out by selecting the corresponding checkbox.

## 4.2 Test

The function test is available for the structured test of the VAV boxes.

Several consecutive commands [see 4.2.1] are defined in a test script file. When the function is started, a trend recording is triggered.

#### Select test file

Select the desired script with the test file combobox.

#### Start test script

Click the test button ▶.

---

#### **Important note**

Before starting the actual script, the application checks whether the air flow/system pressure is sufficient for the actuator test. (If the system pressure is insufficient, this test can last up to 3 minutes.)

---

### 4.2.1 Test scripts

The following test scripts are available.

Name of the test file	Functions
Basic_VAV_Test Max-Min 5m.bptts	V'max – 2 minutes V'min – 2 minutes
Test_VAV_0 CAV (Open-Max-Min-Close) 8m.bptts	Open – 1 ½ minutes V'max – 2 minutes V'mid – 2 minutes V'min – 2 minutes Close – 1 ½ minutes
Test_VAV_Max-75-50-25-Min-Close 3h.bptts	Open – 2 minutes V'max – ½ hour SetPoint 75% – ½ hour SetPoint 50% – ½ hour SetPoint 25% – ½ hour V'min – ½ hour
Test_VAV_Max-Auto-Min 9m.bptts	V'max – 3 minutes Auto – 3 minutes V'min – 3 minutes
Test_VAV_Max-Auto 6m.bptts	V'max – 3 minutes Auto – 3 minutes
Test_VAV_Max-Mid-Min 9m.bptts	V'max – 3 minutes V'mid – 3 minutes V'min – 3 minutes
Test_VAV_Max-Min-Max[ 1_Percent ] 37m.bptts	SetPoint 100% - 2 minutes (afterwards in steps of 1%) SetPoint 99%...0% - every 10 seconds SetPoint 1%...100% - every 10 seconds
Test_VAV_Max 3m.bptts	VMax – 3 minutes
Test_VAV_Open-Max-75-50-25-Min-Close22m.bptts	Open – 3 minutes V'max – 3 minutes SetPoint 75% – 3 minutes SetPoint 50% – 3 minutes SetPoint 25% – 3 minutes V'min – 3 minutes

### 4.3 Reading out sensors and switches

The values of integrated sensors and switches can be read out in MP mode. This function, however, must be activated in the PC-Tool options "General" in advance. Select Tools ▶ PC-Tool options... in the main menu.

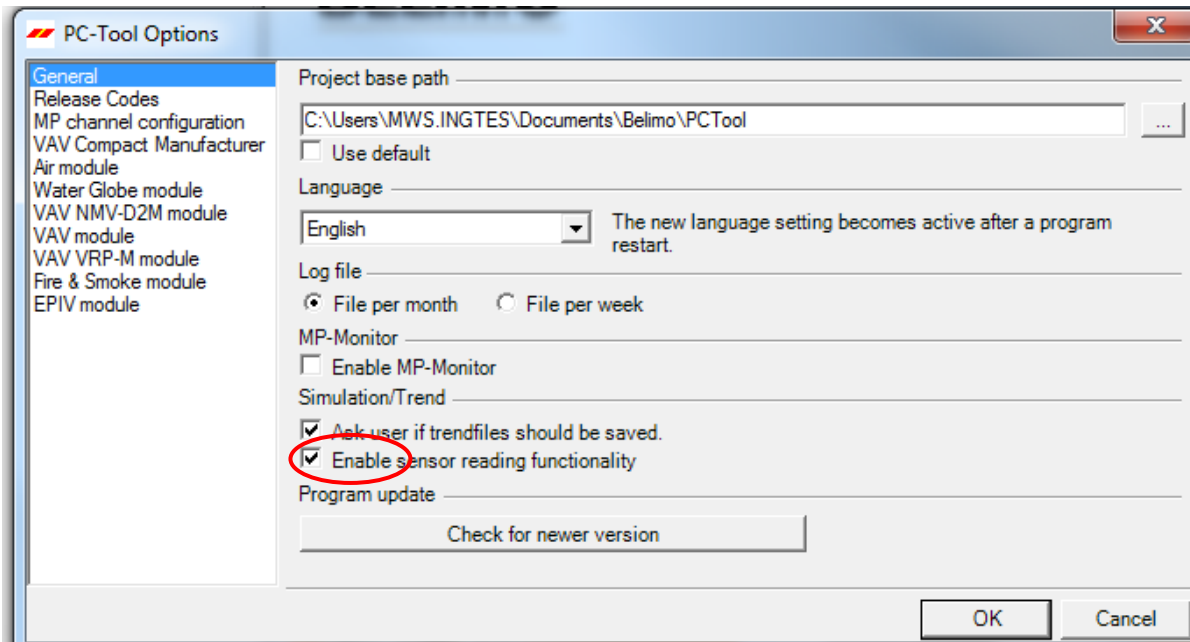

On the Simulation tab, a section with the sensor values is displayed to the right of the actuator control.

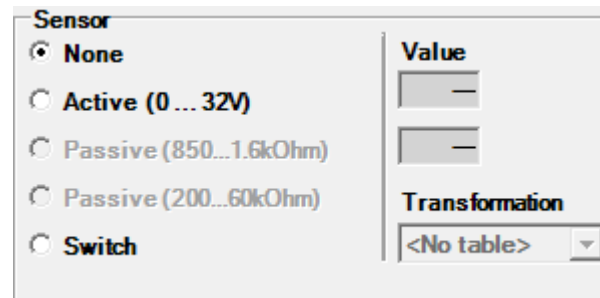

Sensor display in MP mode

Select the type of the connected sensor with the radio buttons. The value is either displayed in volts (active) or as on/off (switch).

The transformation table allows you to additionally convert the raw value of the sensor into the corresponding measuring quantity (temperature etc...). (See the "Transformation table" section in the General User Manual)

### 4.4 Trend recording

During simulation, the time progress of the setpoints and actual values can be displayed in a plot. The values are saved in a trend file and can be displayed later again. Furthermore, you can add any comment texts you would like.



On trend record, the trend is automatically saved to a temporary file and retained for one month. Click on the icon "Save" to save the trend with a different name and location (after stop record).

In the PC tool options "General" specify whether the program should ask for the new file name (ask user if trend files should be saved). The suggested file name can be modified before saving the file.



Click the "Trend Record" button during simulation. The display changes to a "flat" button. The recording stops when you click again.



The position is queried every second by default. You can change the query interval in an input box. The permitted values are 0 to 9999 seconds, whereby the value 0 means "no waiting time" (query as quickly as possible).

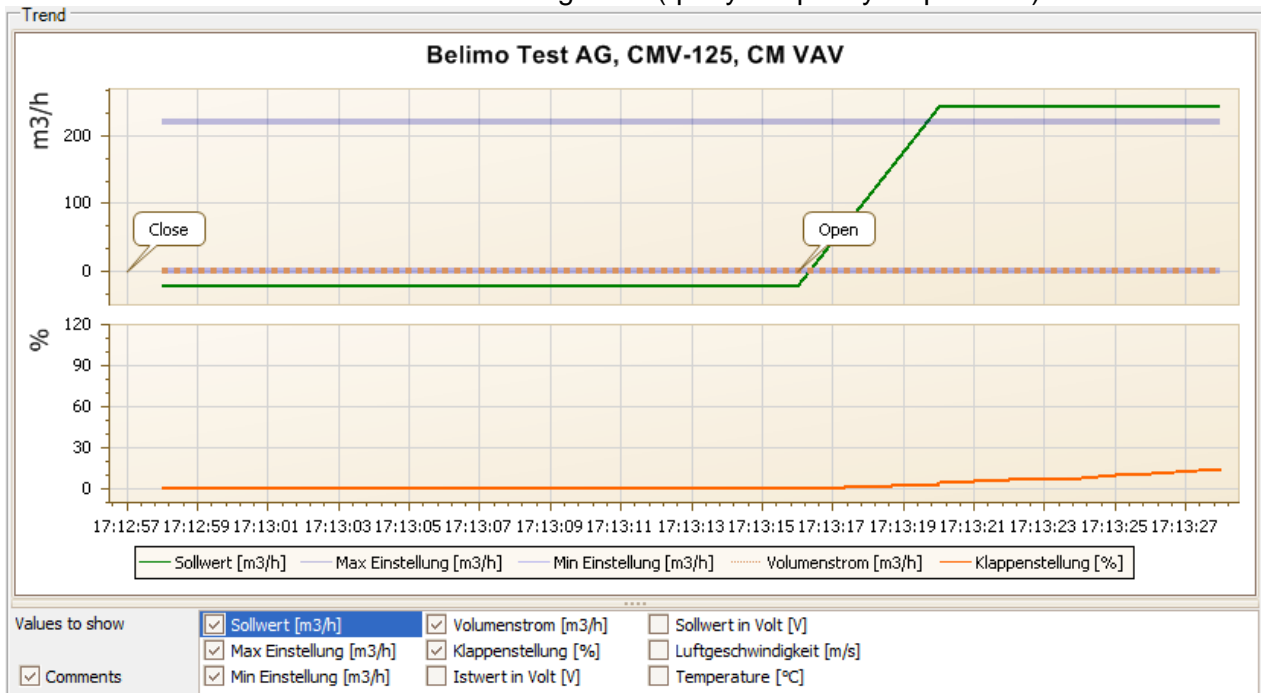

Trend diagram

The Comment button allows you to enter a text at a defined time and the text is then saved in the trend file.

Override events are automatically logged with timestamp as comment.

If you want to record a trend for more than one hour (long-term trend), enter a value of at least 2 seconds for the sampling interval. If the interval is shorter, too many data points will result and the time for correcting the curve between the queries can become too short.

## 5 PC-Tool options

For the CM-VAV module the same options as for VAV compact module are valid. Select Tools ► PC-Tool options... in the main menu.

Variant Click the project in the outline bar [C] with the right mouse button and select PC-Tool options.

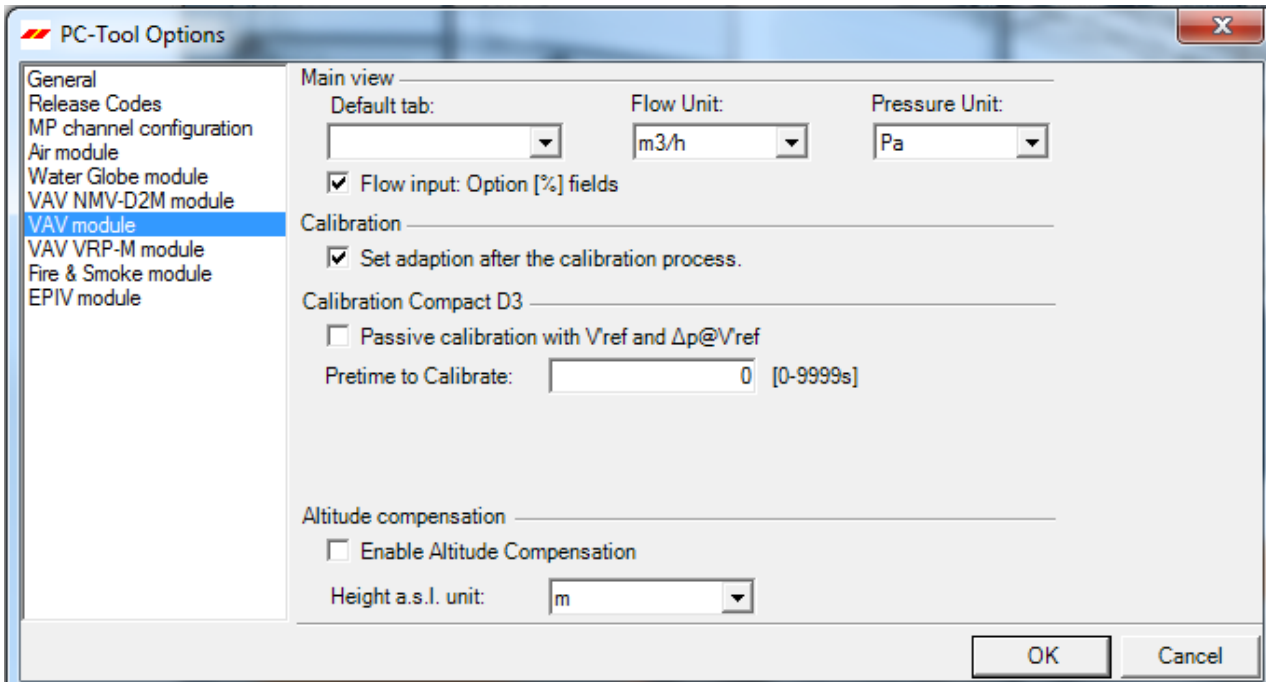

Dialog for basic settings (VAV-module)

Click the "VAV-module" on the left.

### Main window

Depending on the most common application, set which tab should be opened by default when the program is started with the "Default tab" combobox.

With the Volume display combobox, you determine the physical units for the volumetric flow.

- m<sup>3</sup>/h (cubic meters per hour)
- l/s (liters per second)
- cfm (cubic feet per minute)

If you would like to have the option of entering the volumetric flow as a percentage, activate the "volumetric flow input: Option [%] boxes" checkbox.

### Altitude compensation

The altitude compensation can be activated through the checkbox. The actuator is then able to supply, on the basis of the entered altitude of installation in the configuration tab, the altitude compensated differential pressure and the altitude compensated flow rate values.

With the Height a.s.l.(above sea level) unit combobox you can determine the

physical units for the operating altitude of the plant

- m (Meter)
- ft (Feet)

# **PC-Tool V3.16 MP-Monitor**

## **User Manual**

### **English**

#### **MP-Monitor**



## Table of Contents

1	Introduction.....	3
2	Functions.....	4
2.1	Preparations.....	4
2.2	Start MP-Monitor .....	4
2.3	Select operating mode.....	6
2.4	Communication analysis (F1) .....	6
2.5	Application analysis (F3) .....	8
2.6	Log files.....	10
2.6.1	Communication analysis log file.....	10
2.6.2	Application analysis log file.....	11
3	Wiring diagrams.....	12
3.1	Mode switch set to "MO" (monitor) .....	12
3.2	Diagram Variant 1 with ZK2-GEN cable .....	12
3.3	Diagram Variant 2 with ZKS-MP cable .....	13

# 1 Introduction

This user manual is directed toward Belimo system integrators and employees who use the MP-Monitor for analyzing data traffic and for diagnosing problems on networks with the MP-Bus.

The MP-Monitor allows system monitoring without malfunctions caused by the PC-Tool as MP master.

All recorded values are stored with timestamp in files for later evaluation and documentation (see Section 2.6 "Log files").

## 2 Functions

### 2.1 Preparations

Connect the MP-Bus to a serial (COM) interface of your computer as described in Section 3 "Wiring diagrams". If you start the MP monitor from the PC-Tool application, the same serial interface is used which is configured for the MP-Channel.

In order to use another serial interface, you can start the MP-Monitor outside of PC-Tool (see below).

### 2.2 Start MP-Monitor

In order for you to be able to use the MP-Monitor, you must activate the corresponding function in the PC-Tool options under "General".

Select Tools►PC-Tool options... in the main menu.

**Variant** Click the project in the outline bar [C] with the right mouse button and select PC-Tool options.

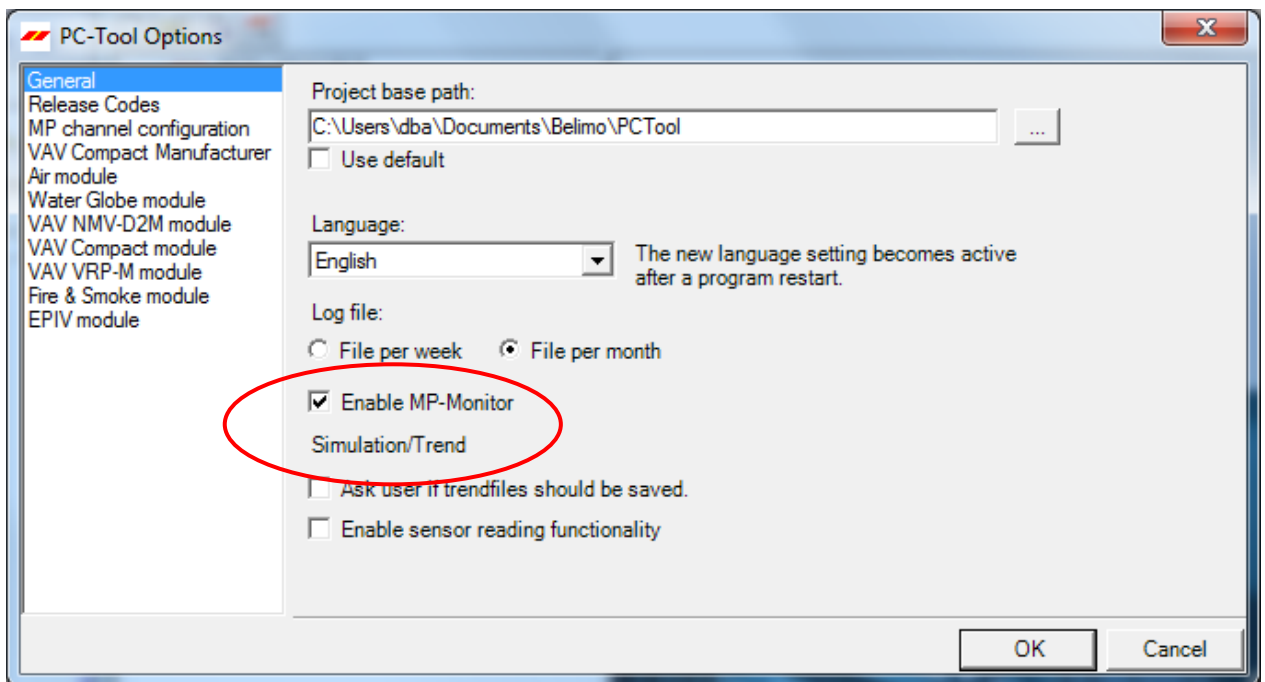

*Settings for activating the MP-Monitor*



Then select MP-Monitor ► Start MP-Monitor in the main menu or click the "Start MP-Monitor" icon in the toolbar.

The PC-Tool program window is closed and a console window (DOS box) is displayed for selecting the operating mode.

### Start MP-Monitor outside of PC-Tool

In order to use another interface other than the one configured in PC-Tool, close the PC-Tool program. In the Explorer, change to the installation directory of PC-Tool (default 'C:\Programme\Belimo\Belimo PC Tool V3.x')

---

If you start the MP-Monitor outside of PC-Tool, you have to have write authorization in the installation directory of PC-Tool since the log files are stored there.

---

Execute the program by double-clicking on the program "mp\_mon.exe". A console window (DOS box) is displayed.

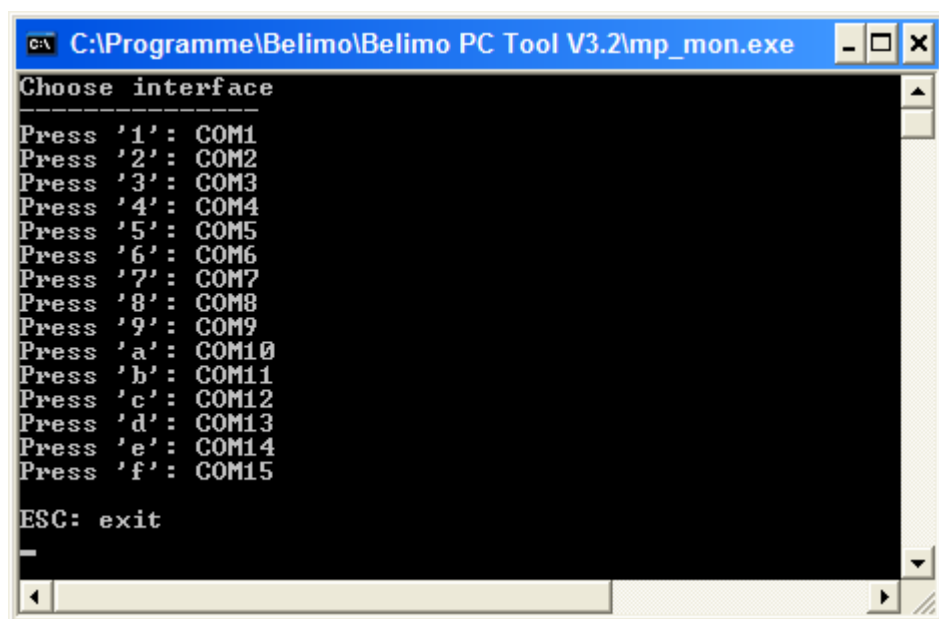

*Selection of the serial interface COM1...COM15*

With the specified buttons '1', '2', ...'f', you can select the serial interface which is connected with the MP-Bus.

Afterwards, the window for selecting the operating mode is displayed.

## 2.3 Select operating mode

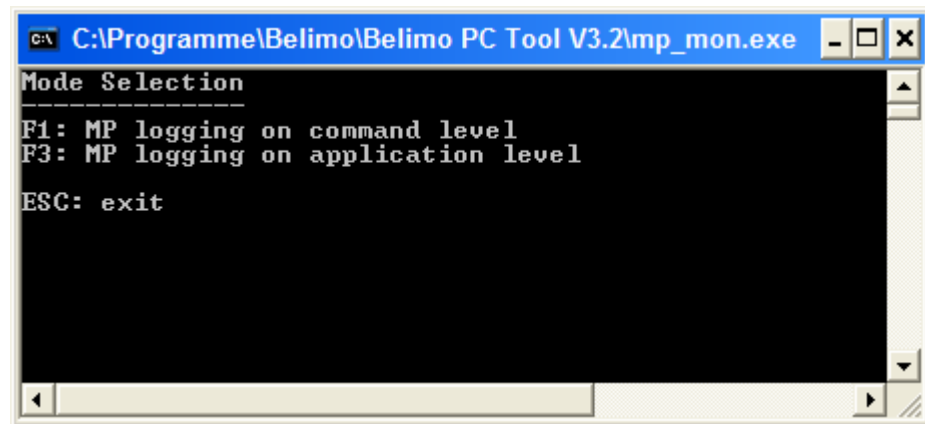

Select the operating mode

Select the operating mode with the function key 'F1' or 'F3':

**F1:** Display of commands which are sent over the bus (communication analysis)

**F3:** Display of positions, control and sensor values (application analysis).

## 2.4 Communication analysis (F1)

In the communication analysis, commands are recorded which are sent over the MP-Bus. The transferred data bytes and checksums are represented as hexadecimal numbers.

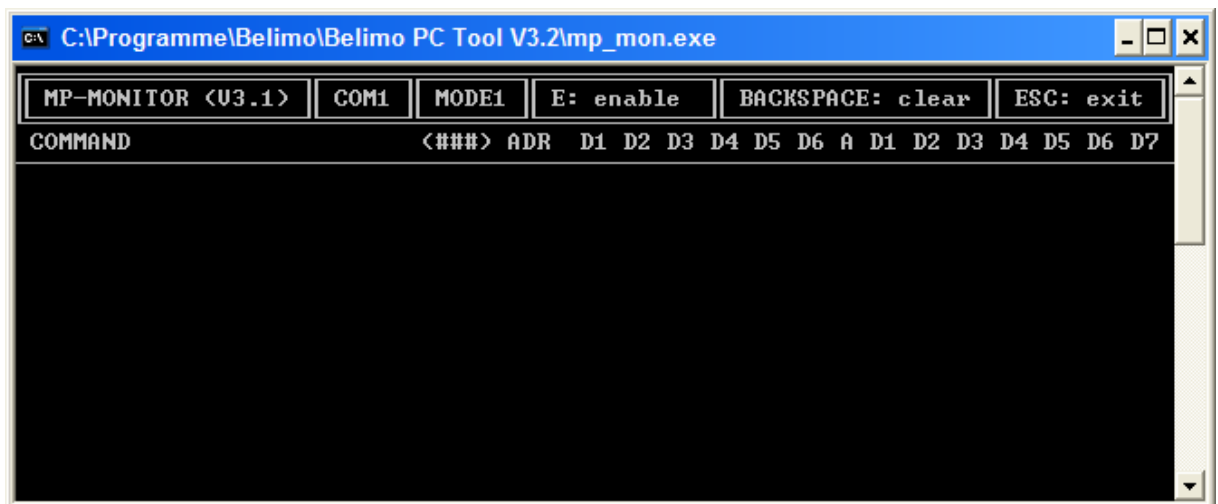

Start window of the communication analysis

The capture of the traffic starts automatically and can be stopped by pressing the 'D' button.

Press the 'E' button to start the recording again.

You can delete the display with the Backspace key and close the program with the Escape key.

C:\Programme\Belimo\Belimo PC Tool V3.2\mp_mon.exe																
MP-MONITOR <U3.1>	COM1	MODE1	D: disable				BACKSPACE: clear				ESC: exit					
COMMAND	<###>	ADR	D1	D2	D3	D4	D5	D6	A	D1	D2	D3	D4	D5	D6	D7
PEEK	<001>	MP1	FB	10	07				Y	4E	56	32	34	4C	4F	4E
PEEK	<001>	MP1	FB	17	07				Y	20	55	53	20	20	20	20
PEEK	<001>	MP1	FB	1E	02				Y	20	20					
GET_SERIESNO	<050>	MP1							Y	02	72	4E	2D	33	80	35
SET_FORCED_CONTROL	<014>	MP1	00						Y							
SET_RELATIVE	<037>	MP1	00	00					Y							
GET_RELATIVE	<041>	MP1							Y	00	00	00	00			
GET_TRANSIT_TIME	<032>	MP1							Y	C0	F0	07	D0	00	46	
PEEK	<001>	MP1	FB	20	07				Y	20	20	20	20	20	20	20
PEEK	<001>	MP1	FB	27	07				Y	20	20	20	20	20	20	20
PEEK	<001>	MP1	FB	2E	02				Y	20	20					
GET_SERIESNO	<050>	MP2							N							
SET_FORCED_CONTROL	<014>	MP1	00						Y							
SET_RELATIVE	<037>	MP1	00	00					Y							
GET_RELATIVE	<041>	MP1							Y	00	00	00	00			
GET_TRANSIT_TIME	<032>	MP1							Y	C0	F0	07	D0	00	46	
GET_SETTINGS	<012>	MP1							Y	00	00	64	AA	01	55	
GET_SERIESNO	<050>	MP3							N							
SET_FORCED_CONTROL	<014>	MP1	00						Y							
SET_RELATIVE	<037>	MP1	00	00					Y							
GET_RELATIVE	<041>	MP1							Y	00	00	00	00			
GET_TRANSIT_TIME	<032>	MP1							Y	C0	F0	07	D0	00	46	
GET_MIN_MID_MAX	<059>	MP1														

*Recording of communication over the MP-Bus*

Meaning of the display

Column	Description
COMMAND	Name of the command
(###)	Command code
ADR	MP address
D1 ... D7	Data bytes, hexadecimal
A	'Y' = response, 'N' = no response

Additional information is contained in the log file, which is written parallel to recording (start byte, check bytes). See also Section 2.6.1 "Communication analysis log file".

## 2.5 Application analysis (F3)

In the application analysis, the MP-Monitor does not show the individual commands, but the configuration settings, set/actual positions, volumetric flows for VAV actuators and sensor values.

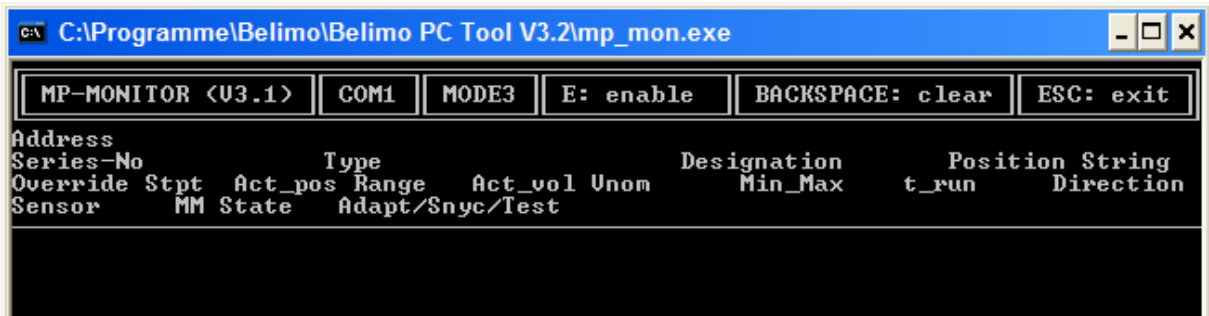

Start window for the application analysis

The capture of the traffic starts automatically and can be stopped by pressing the 'D' button.

Press the 'E' button to start the recording again.

You can delete the display with the Backspace key and close the program with the Escape key.

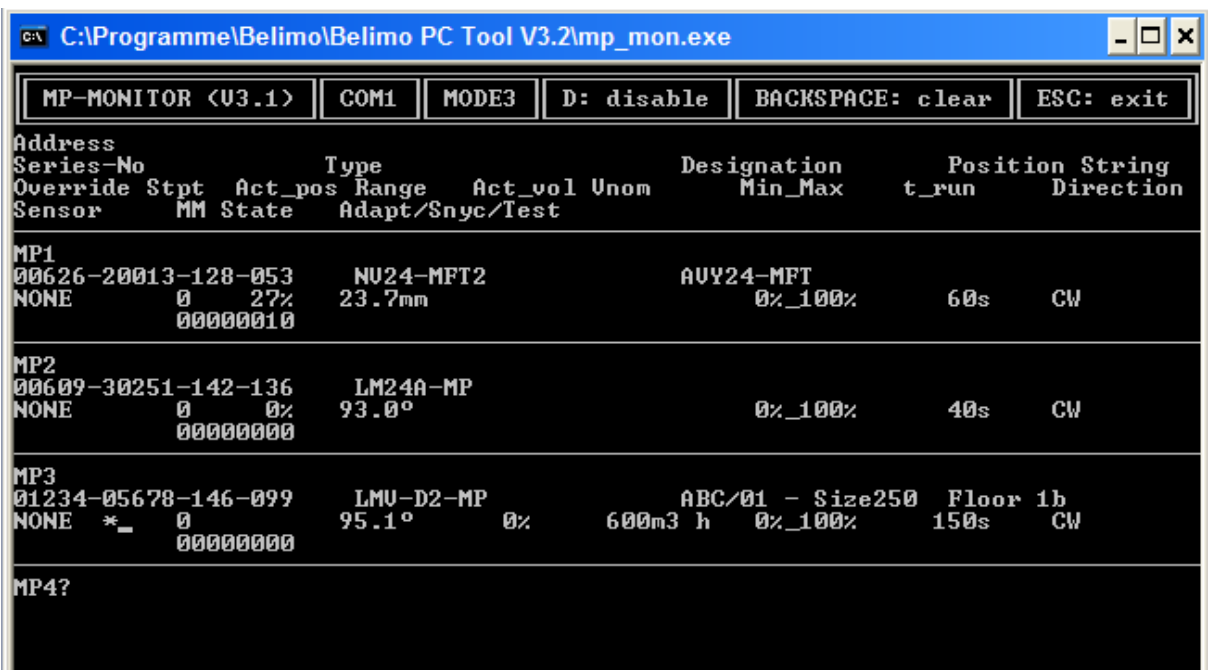

Recording for positions, control and sensor values

The MP-Monitor does not determine the configuration settings actively by reading them out of the actuator, but collects the data transmitted over the MP-Bus. For this reason, the display is built up slowly, step-by-step. If the MP-Master does not query a piece of information, then it is also not displayed.

The recording per bus address consists of four lines. To interpret a value, see the corresponding line and position in the table header.

Meaning of the display

Column	Description
Address	MP address of the actuator
Serial no.	Serial number of the actuator
Type	Actuator type
Designation	Designation
Position string	Position
Override	Digital override via MP-Bus
Stpt	Setpoint
Act_pos	Actual position
Range	Angle of rotation/stroke range
Act_vol	Actual volumetric flow (VAV only)
Vnom	Nominal volumetric flow (VAV only)
Min_Max	Minimum & maximum of the range
t_run	Running time
Direction	Rotation/stroke direction
Sensor	Sensor value
MM state	<i>see below</i>
Adapt/Sync/Test	Adaptation, synchronization or test active

**MM state**

**Messages which are set in the actuator (bit representation)**

Explanation:

If all bits are set to 0, no message is set in the actuator.

If individual bits are set to 1, this means that the corresponding messages are active and are set in the actuator.

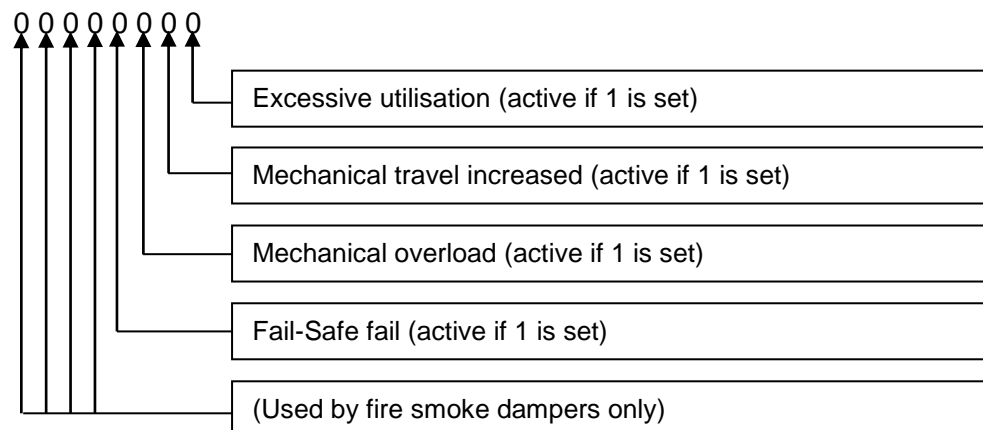

The messages can be seen in plain text in the respective PC-Tool module.



## 2.6 Log files

The log files of the MP-Monitor with the recordings are stored in the user-specific project directory of PC-Tool (default 'C:\Documents and Settings\\My Documents\Belimo\PCTool\\monitor files\').

The program stores files for every program start with current date and time ('mp 2012-11-23 14-25-30.txt'). For records over a longer period, a new file will be saved every 24 hour.

### 2.6.1 Communication analysis log file

Date: 21.07.2008 Time: 15:51:58														
	adr	command	(###)	st	cc	d1	d2	d3	d4	d5	d6	d7	c1	c2
15:51:59.34	MP1	SET_FORCED_CONTROL	(014)	20	0E	00							60	4E
15:51:59.39		Y		0D									80	8D
15:51:59.48	MP1	SET_RELATIVE	(037)	30	25	00	00						20	35
15:51:59.53		Y		0D									80	8D
15:51:59.59	MP1	GET_RELATIVE	(041)	10	29								C0	F9
15:51:59.69		Y		4D	00	00	00	00					00	4D
15:51:59.78	MP1	AD_CONVERT	(004)	30	04	04	AA						60	FA
15:51:59.83		Y		2D	01	A0							40	CC

Each entry consists of 2 lines. The first line shows the sent command, and the second line, marked with 'Y' shows the response.

Column	Description
adr	MP address
command	Name of the command
(###)	Command code, decimal
st	Start byte, hexadecimal
cc	Command code, hexadecimal
d1 ... d7	Data bytes, hexadecimal
c1	Cross parity (check byte), hexadecimal
c2	Length parity (check byte), hexadecimal

## 2.6.2 Application analysis log file

This log file contains the data transmitted over the MP-Bus in chronological order in a readable format.

```
21.07.2008;15:52:26.24;MP1;Type;LR24A-MP
21.07.2008;15:52:27.08;MP1;Override;NONE
21.07.2008;15:52:27.22;MP1;Setpoint; 0;%
21.07.2008;15:52:27.38;MP1;Actual position; 0;%
21.07.2008;15:52:27.53;MP1;Sensor Value; 0.4;V
21.07.2008;15:52:27.69;MP3;Override;NONE
21.07.2008;15:52:27.81;MP3;Setpoint; 0;%
21.07.2008;15:52:27.99;MP3;Actual position; 10;%
```

Each entry consists of several values which are separated from each other by semicolons:

- Date
- Time
- Bus address
- Property
- Value(s)
- Unit(s)

### Evaluation with MS Excel

For an easy-to-understand illustration and evaluation, the text format of the MP log files can be opened directly with the MS Office application Excel.

When opening in Excel, select "Text files (\*.prn, \*.txt, \*.csv)" as the data type and the semicolon (;) as the separator.

With the autofilter function (Data menu ▶ Filter ▶ Autofilter), comboboxes are shown in the first lines of the tables. There you can select the bus addresses or properties which you are interested in.

The filtered values can be displayed as a diagram, for example.

### 3 Wiring diagrams

#### 3.1 Mode switch set to "MO" (monitor)

The mode switch on the ZIP-USB-MP must be set to "MO" if working with the MP-Monitor.

Note: The mode switch must first be set to "MO" before the MP-Monitor can be opened in the PC-Tool.

**Attention:** ZIP-USP-MP devices off a newer generation have no switch to toggle between MO and MA operating mode. These devices switch automatically into Monitor mode when Monitor tool has been started.  
Precondition: The Monitor tool has a Version number V3.5 or higher.

#### 3.2 Diagram Variant 1 with ZK2-GEN cable

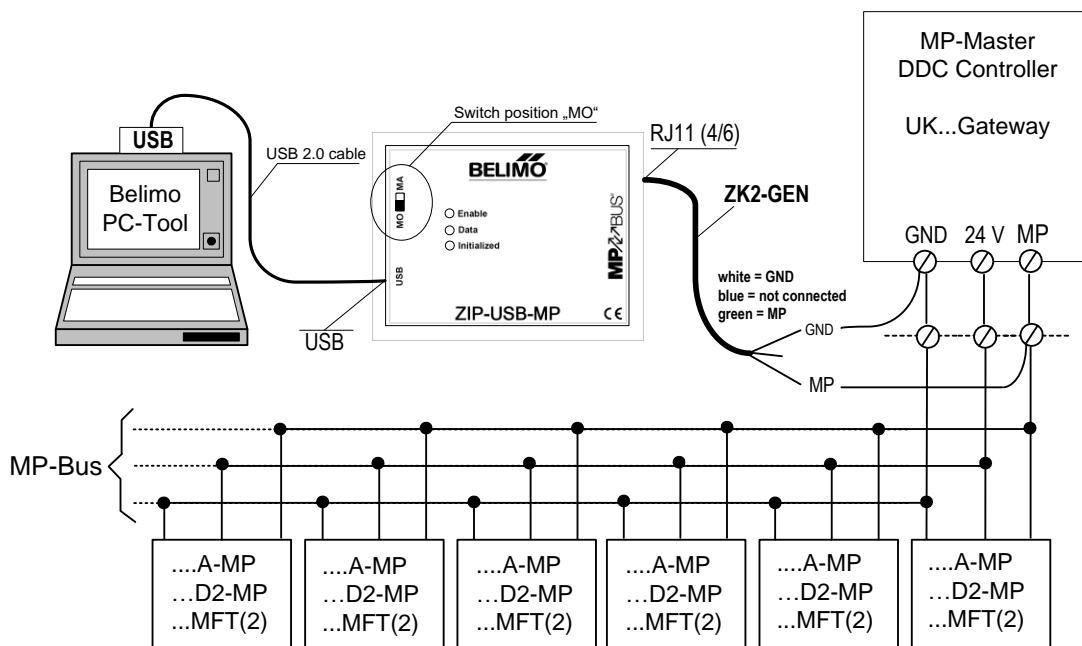

### 3.3 Diagram Variant 2 with ZKS-MP cable

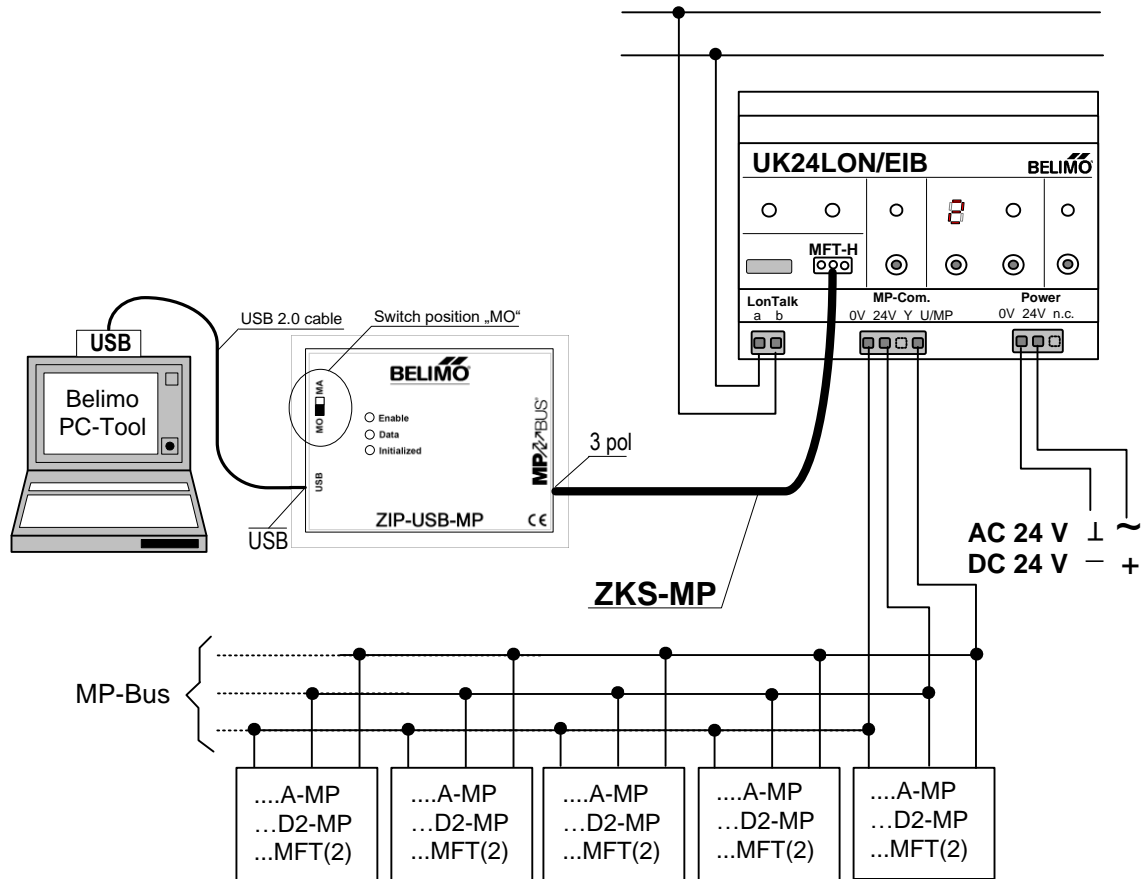

# **PC-Tool V3.16 VAV-Universal (VRU)**

## **User Manual**

### **English**

# Table of Contents

1	Introduction.....	3
2	VRU-D3-BAC / VRU-M1-BAC.....	4
2.1	Displayed settings .....	4
2.2	Flow measurement Application.....	7
2.3	Flow Control Applications .....	8
2.4	Duct Pressure control Application.....	9
2.5	Enable Trend functionality .....	10
3	VRU-M1R-BAC.....	11
3.1	Displayed settings .....	11
3.2	Room Pressure Application .....	14
3.3	Enable Trend functionality .....	15

# 1 Introduction

The VAV-Universal (VRU) user manual describes the detail area [D] of the module for all versions of this product (VRU-D3-BAC, VRU-M1-BAC, and VRU-M1R-BAC). The documentation is divided accordingly to present the specific characteristics for each product family.

## VAV-Universal product range

The modular structure of the VAV-Universal controller product range with integrated differential pressure sensor enables the ideal combination of controller and damper motorization. With this product range, individual solutions for all special applications in the field of ventilation can be created.

### Applications

- Volumetric flow VAV/CAV.
- Volumetric flow summation.
- Duct and room pressure.

### Differential pressure sensor

- D3 – Flow (dynamic) suitable for comfort zone.
- M1 – Diaphragm (static) suitable for polluted air.
- M1R – Diaphragm (static) for room pressure control.

---

### Note

For function and wiring, see VAV-Universal product information VRU-D3-BAC, VRU-M1-BAC, VRU-M1R-BAC

---

## 2 VRU-D3-BAC / VRU-M1-BAC

### 2.1 Displayed settings

PC-Tool gives in a single tab an overview of the current settings of the VRU-D3-BAC or VRU-M1-BAC controller.

Type <b>VRU-D3-BAC</b> Designation <b>QUIX Line DN125</b> Position <b>Room 345G</b>		SN <b>21947-30009-032-029</b> Address <b>PP</b>		
<b>Basic Settings</b> Designation <input type="text" value="QUIX Line DN125"/> Position <input type="text" value="Room 345G"/> Application Type <input type="text" value="VAV Control"/> Control Type <input type="text" value="VAV-CAV"/> Pressure Cascade <input type="text" value="Off"/>		<b>Application Control Settings Y / U</b> Setpoint Offset <input type="text" value="0.0"/> -5.0..5.0 % Setpoint Signal <input type="text" value="DC variable"/> Start <input type="text" value="0.6"/> 0.5..8.0 VDC Stop <input type="text" value="10.0"/> 2.6..10.0 VDC Feedback Parameter <input type="text" value="Flow"/> Feedback U <input type="text" value="DC 2-10V"/>		
<b>OEM Settings</b> Vnom <input type="text" value="450"/> ..50000 m3/h Δp@Vnom_Cal <input type="text" value="150"/> 38..500 Pa <input type="button" value="Calibrate"/> Altitude of Calibration <input type="text" value="200"/> 0..3000 m Dir. of Rotation <input type="text" value="ccw"/> NFC Interface <input type="text" value="Read/write"/>		<b>Installation</b> Active Time <input type="text" value="0"/> h Operating Time <input type="text" value="0"/> h Changes In Direction <input type="text" value="84"/> Mechanical Overloads <input type="text" value="67"/> Actuator State <input type="text" value="OK"/>		
<b>Project Settings</b> Altitude compensation <input type="text" value="On"/> Altitude of installation <input type="text" value="410"/> 0..3000 m Vmax <input type="text" value="324"/> 90..450 m3/h Vmin <input type="text" value="216"/> ..324 m3/h		<b>Simulation</b> Control <input type="text" value="Simulation off"/> Applied Setpoint <input type="text" value="216"/> m3/h Airflow absolute <input type="text" value="0"/> m3/h Δp <input type="text" value="1"/> Pa Damper position <input type="text" value="100"/> %		
<b>Communication</b> Bus Protocol <input type="text" value="MP"/> Compatibility-Mode <input type="text" value="Standard"/>		<b>Adaption / Synchronization / State</b> Synchronization <input type="text" value="Synchronisation"/> Adaption <input type="text" value="Adaption"/> State <input type="text" value="Control"/>		
<b>Actuator Settings</b> Serial Number Actuator <input type="text" value="01939-30043-140-126"/> Synchronization at <input type="text" value="Y=0%"/> Power ON behavior <input type="text" value="No action"/> Nominal range <input type="text" value="Adapted"/> Nominal range <input type="text" value="93.37"/> ..96.00 °				

Main view of a VRU-D3-BAC device

Type <b>VRU-M1-BAC</b> Designation <b>Buero Hinwil</b> Position <b>Buero Hinwil</b>		SN <b>21939-30017-032-029</b> Address <b>PP</b>		

Difference in the view of a VRU-M1-BAC device

The displayed settings will vary depending on the application selected for the device and the specific settings of every available field.

A description of the available settings, as well as the applications were they are visible, can be found in the table below.



Settings Description

		VAV-Control	Flow Meas.	Duct Pressure
<b>Basic Settings</b>				
Designation	Description of the device. 16 characters of any text.	X	X	X
Position	Identification of the location / plant of the device. 32 characters of any text.	X	X	X
Application Type	Active application (VAV-Control / Flow Meas. / Pressure control)	X	X	X
Control Type <sup>1</sup>	Active control type (VAV-CAV / Position control)	X		
Pressure Cascade <sup>1</sup>	Room Pressure cascade application (On / Off) Enables VAV unit as: Secondary circuit VAV.	X		
<b>OEM Settings</b>				
V'nom <sup>1</sup>	Nominal volumetric flow rate (OEM parameter). OEM specific parameter set by the manufacturer of the VAV-box.	X	X	
$\Delta p@V'nom\_Cal$ <sup>1</sup>	Calibration value (OEM parameter) OEM specific parameter set by the manufacturer of the VAV-box during the calibration run.	X	X	
Altitude of Calibration <sup>1</sup>	Altitude at which the VRU controller is calibrated. OEM specific parameter set by the manufacturer of the VAV-box.	X	X	
Pnom <sup>1</sup>	Nominal pressure. Specific parameter set by the manufacturer of the control damper solution.			X
Controller Sensitivity	Defines sensitivity of the controller (0.10-10.00)			X
Controller Deadband	Defines the dead band of the controller (1.0-10.0 %)			X
Dir. of Rotation	Damper actuator opening in clockwise / counterclockwise direction.	X		X
NFC Interface	NFC mode (Read / Write).	X	X	X
<b>Project Settings</b>				
Altitude Compensation	Enables altitude compensation calculations (On / Off)	X	X	X
Altitude of Installation	Operating altitude of the plant.	X	X	X
V'max / Pmax / max	Upper limit of operating volumetric flow / pressure / damper position setting (Relative to the application selected).	X	X	X
V'min / Pmin / min	Lower limit of operating volumetric flow / pressure / damper position setting (Relative to the application selected).	X	X	X
Suppress damper leakage <sup>1</sup>	Enables damper leakage compensation calculations (On / Off)	X		
<b>Communication</b>				
Bus Protocol	Defines bus protocol used (MP / BACnet MS/TP / Modbus RTU)	X	X	X
Compatibility Mode	Only used in existing MP-Bus systems, in case a VRP-M is replaced by a VRU controller (MP address 1...8) (Standard / VRP-M)	X	X	X
MAC Address <sup>1</sup>	Defines the address of the actuator (BACnet: 1-127 / Modbus: 1-247)	X	X	X
Baudrate <sup>1</sup>	Defines the communication baud rate. (9600 / 19200 / 38400 / 76800 / 115200)	X	X	X
Terminating Resistor <sup>1</sup>	Terminating resistor is present in bus (On / Off)	X	X	X
Instance Number <sup>1</sup>	Defines BACnet instance number (1-4194304)	X	X	X
Device Name <sup>1</sup>	Defines BACnet device name. 32 characters of any text.	X	X	X
Max. Master <sup>1</sup>	Defines maximum BACnet Master (1-127)	X	X	X
Parity <sup>1</sup>	Defines Modbus parity (1-8-N-2 / 1-8-E-1 / 1-8-O-1 / 1-8-N-1)	X	X	X

		VAV-Control	Flow Meas.	Duct Pressure
<b>Actuator Settings</b>				
Serial Number <sup>1</sup>	Shows the serial number of the actuator. Read only	X		X
Synchronization at	Stop position 0% or 100%.	X		X
Power ON behavior	Behavior when system is switched on or after a voltage interruption (No action / Adaption / Synchronization).	X		X
Nominal range (Menu)	Angle of rotation range, defines the range limitation (Adapted / Programmed)	X		X
Nominal range (Number)	Adapted: To the range of rotation from the mechanical stop settings. Programmed: Selects the maximum angle of rotation.	X		X
<b>Application Control Settings Y / U</b>				
Setpoint	Defines the source of the setpoint received (Bus / Analog).	X	X	X
Setpoint Offset	Room pressure balance, offset for exhaust air box. (+/- correction to the received setpoint signal)	X		
Setpoint Signal	Defines the setpoint signal type	X		X
0...10 V	Fixed operating range from 0 to 10 V	X		X
2...10 V	Fixed operating range from 2 to 10 V	X		X
Variable	Voltage range can be defined: Start 0.0...8.0 V / Stop 2.0...10.0 V Range between start and stop must be at least 2 V.	X		X
Feedback Parameter	Defines the feedback received (Position / Flow / Δp)	X	X	X
Feedback U	Defines the feedback signal type	X	X	X
0...10 V	Fixed operating range from 0 to 10 V	X	X	X
2...10 V	Fixed operating range from 2 to 10 V	X	X	X
Variable	Voltage range can be defined: Start 0.0...8.0 V / Stop 2.0...10.0 V Range between start and stop must be at least 2 V.	X	X	X
<b>Installation</b>				
Active Time <sup>1</sup>	Motor active time in hours.	X	X	X
Operating Time	Powered time in hours.	X	X	X
Changes in Direction <sup>1</sup>	Direction change counter.	X		X
Mechanical Overload <sup>1</sup>	Mechanical overload counter.	X		X
Actuator State <sup>1</sup>	Feedback Status from actuator (OK / Cannot Move / Gear disengaged / Travel increased / Actuator doesn't match)	X		X
<b>Simulation</b>				
Control	Actuators behavior for the simulation (Open / Close / V'nom, P'nom/ V'mix, P'min, Min / V'max ,P'max, Max / Motor Stop / Setpoint %)	X		X
Applied Setpoint	Actual defined setpoint (Units depending on Application)	X		X
Airflow absolute	Actual airflow value	X	X	
Δp	Actual Δp Value	X	X	X
Damper position <sup>1</sup>	Actual damper position	X		X

Synchronization / Adaption / State		VAV-Control	Flow Meas.	Duct Pressure
Synchronization	Moves to a mechanical limit (according to the setting "Synchronization at").	X		X
Adaption	Moves to both mechanical limits and recalculates angle-dependent parameters.	X		X
State	Shows status of the actuator. If no synchronization or adaption is in progress, the displayed value is "Control".	X		X

<sup>1</sup> The visualization of the setting is influenced by the overall settings of the controller and / or release codes.

## 2.2 Flow measurement Application

Volumetric flow measuring device (transmitter) for recording or monitoring a volumetric flow.

For a more detailed information about the application, please consult the document *Room and system applications with VAV-Universal*.

Type **VRU-D3-BAC**  
 Designation **QUIX Line DN125**  
 Position **Room 345G**

SN **21947-30009-032-029**  
 Address **PP**

**Basic Settings**

Designation

Position

Application Type

**OEM Settings**

Vnom  ..50000 m3/h

$\Delta p@Vnom\_Cal$   38..500 Pa Calibrate

Altitude of Calibration  0..3000 m

NFC Interface

**Project Settings**

Altitude compensation

Altitude of installation  0..3000 m

**Communication**

Bus Protocol

Address  1..247

Baudrate

Terminating Resistor

Parity

**Application Control Settings Y / U**

Setpoint

Feedback Parameter

Feedback U

**Installation**

Operating Time  h

**Simulation**

Airflow absolute  m3/h

$\Delta p$   Pa

Read

Write

Store to file...

Load from file...

Enable Trend

View of a VRU-D3-BAC device with Flow measurement application active

## 2.3 Flow Control Applications

### VAV - Variable or CAV - Constant air volume control

- Variable air volume control (VAV): V'min ... V'max.
- Constant air volume control (CAV): Damper Closed / V'min / V'max / Damper open.

### Position Control (Open-Loop)

VAV-Universal VRU-... sensor / actuator in Position Control mode (Open-Loop, VAV control function inactive).

- Volume flow: Display 0 ... 100% of V'nom.
- Damper actuator: Control 0 ... 100% of actuators rotation range.

For a more detailed information about the application, please consult the document *Room and system applications with VAV-Universal*.

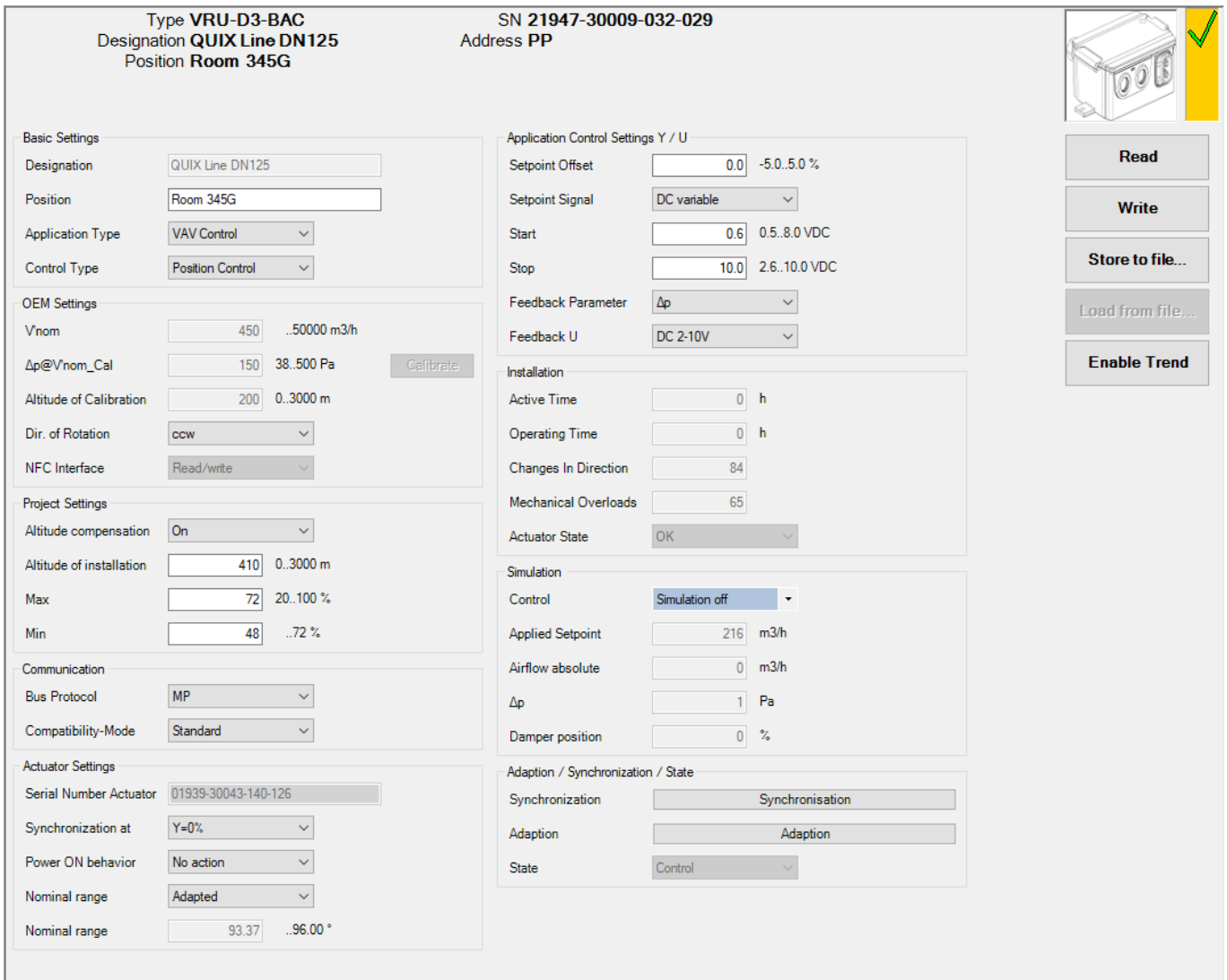

**Type VRU-D3-BAC**  
**Designation QUIX Line DN125**  
**Position Room 345G**

**SN 21947-30009-032-029**  
**Address PP**

**Basic Settings**

Designation: QUIX Line DN125  
 Position: Room 345G  
 Application Type: VAV Control  
 Control Type: Position Control

**OEM Settings**

Vnom: 450 ..50000 m3/h  
 Δp@Vnom\_Cal: 150 38..500 Pa Calibrate  
 Altitude of Calibration: 200 0..3000 m  
 Dir. of Rotation: ccw  
 NFC Interface: Read/write

**Project Settings**

Altitude compensation: On  
 Altitude of installation: 410 0..3000 m  
 Max: 72 20..100 %  
 Min: 48 ..72 %

**Communication**

Bus Protocol: MP  
 Compatibility-Mode: Standard

**Actuator Settings**

Serial Number Actuator: 01939-30043-140-126  
 Synchronization at: Y=0%  
 Power ON behavior: No action  
 Nominal range: Adapted  
 Nominal range: 93.37 ..96.00 °

**Application Control Settings Y / U**

Setpoint Offset: 0.0 -5.0..5.0 %  
 Setpoint Signal: DC variable  
 Start: 0.6 0.5..8.0 VDC  
 Stop: 10.0 2.6..10.0 VDC  
 Feedback Parameter: Δp  
 Feedback U: DC 2-10V

**Installation**

Active Time: 0 h  
 Operating Time: 0 h  
 Changes In Direction: 84  
 Mechanical Overloads: 65  
 Actuator State: OK

**Simulation**

Control: Simulation off  
 Applied Setpoint: 216 m3/h  
 Airflow absolute: 0 m3/h  
 Δp: 1 Pa  
 Damper position: 0 %

**Adaption / Synchronization / State**

Synchronization: Synchronisation  
 Adaption: Adaption  
 State: Control

**Buttons:** Read, Write, Store to file..., Load from file..., Enable Trend

View of a VRU-D3-BAC device with VAV Control application active

## 2.4 Duct Pressure control Application

### Duct Pressure control

- Modulating (STP): P'min ... P'max.
- Constant pressure control (STP): P'min / P'Max / Damper Closed / Damper open / Motor stop

For a more detailed information about the application, please consult the document *Room and system applications with VAV-Universal*.

Type <b>VRU-D3-BAC</b> Designation <b>QUIX Line DN125</b> Position <b>Room 345G</b>		SN <b>21947-30009-032-029</b> Address <b>PP</b>		
<b>Basic Settings</b> Designation: <input type="text" value="QUIX Line DN125"/> Position: <input type="text" value="Room 345G"/> Application Type: <input type="text" value="Duct Pressure"/>		<b>Application Control Settings Y / U</b> Setpoint Signal: <input type="text" value="DC variable"/> Start: <input type="text" value="0.6"/> 0.5..8.0 VDC Stop: <input type="text" value="10.0"/> 2.6..10.0 VDC Feedback Parameter: <input type="text" value="Δp"/> Feedback U: <input type="text" value="DC 2-10V"/>		
<b>OEM Settings</b> Pnom: <input type="text" value="250"/> 38..500 Pa Controller Sensitivity: <input type="text" value="1.00"/> 0.10..10.00 Controller Deadband +/-: <input type="text" value="5.0"/> 1.0..10.0 % Dir. of Rotation: <input type="text" value="ccw"/> NFC Interface: <input type="text" value="Read/write"/>		<b>Installation</b> Active Time: <input type="text" value="0"/> h Operating Time: <input type="text" value="0"/> h Changes In Direction: <input type="text" value="84"/> Mechanical Overloads: <input type="text" value="65"/> Actuator State: <input type="text" value="OK"/>		
<b>Project Settings</b> Altitude compensation: <input type="text" value="On"/> Altitude of installation: <input type="text" value="410"/> 0..3000 m Pmax: <input type="text" value="180"/> 50..250 Pa Pmin: <input type="text" value="120"/> ..180 Pa		<b>Simulation</b> Control: <input type="text" value="Simulation off"/> Applied Setpoint: <input type="text" value="120"/> Pa Δp: <input type="text" value="1"/> Pa Damper position: <input type="text" value="50"/> %		
<b>Communication</b> Bus Protocol: <input type="text" value="MP"/> Compatibility-Mode: <input type="text" value="Standard"/>		<b>Adaption / Synchronization / State</b> Synchronization: <input type="text" value="Synchronisation"/> Adaption: <input type="text" value="Adaption"/> State: <input type="text" value="Control"/>		
<b>Actuator Settings</b> Serial Number Actuator: <input type="text" value="01939-30043-140-126"/> Synchronization at: <input type="text" value="Y=0%"/> Power ON behavior: <input type="text" value="No action"/> Nominal range: <input type="text" value="Adapted"/> Nominal range: <input type="text" value="93.37"/> ..96.00 *				

View of a VRU-D3-BAC device with Duct Pressure application active

## 2.5 Enable Trend functionality

At any moment, the time progress of the setpoint and actual values can be displayed in a plot. This graphic can be visualized through the button "Enable Trend". The values are saved in a trend file and can be displayed again at a later time. Furthermore, you can add any comment texts you would like.



On trend record, the trend is automatically saved to a temporary file and retained for one month. Click on the icon "Save" to save the trend with a different name and location (after stop record).

In the PC tool options "General" specify whether the program should ask for the new file name (ask user if trend files should be saved). The suggested file name can be modified before saving the file.

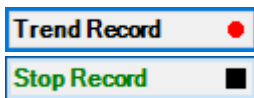

Click the "Trend Record" button. The display changes to a "flat" button with the label "Stop Record". The recording stops when you click the button again.

The position is queried every second by default. You can change the query interval in an input box. The permitted values are 0 to 9999 seconds, whereby the value 0 means "no waiting time" (query as quickly as possible).

If V'nom was set to 0 l/min, then the volumetric flows will be specified in % in the trend display instead of in volumetric units.

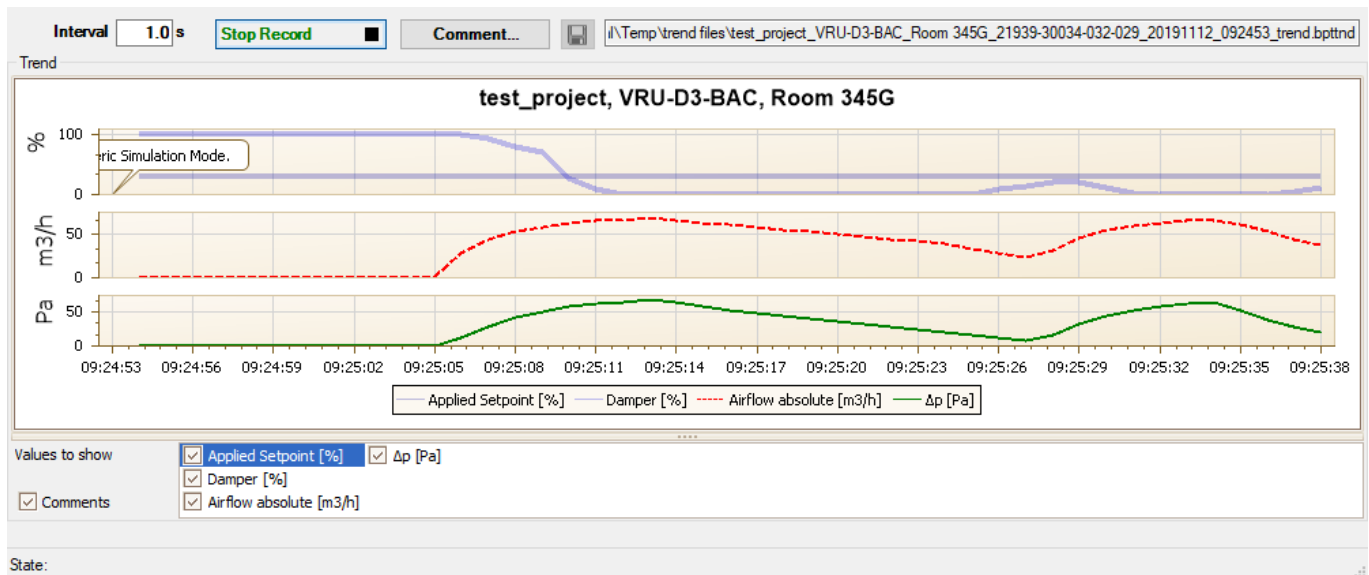

*Trending area available in PC-Tool*

The Comment button allows you to enter a text at a defined time and the text is then saved in the trend file.

Override events are automatically logged with timestamp as comment.

If you want to record a trend for more than one hour (long-term trend), enter a value of at least 2 seconds for the interval. If the interval is shorter, too many data points will result and the time for correcting the curve between the queries can become too short.

### 3 VRU-M1R-BAC

#### 3.1 Displayed settings

PC-Tool gives in a single tab an overview of the current settings of the VRU-M1R-BAC controller.

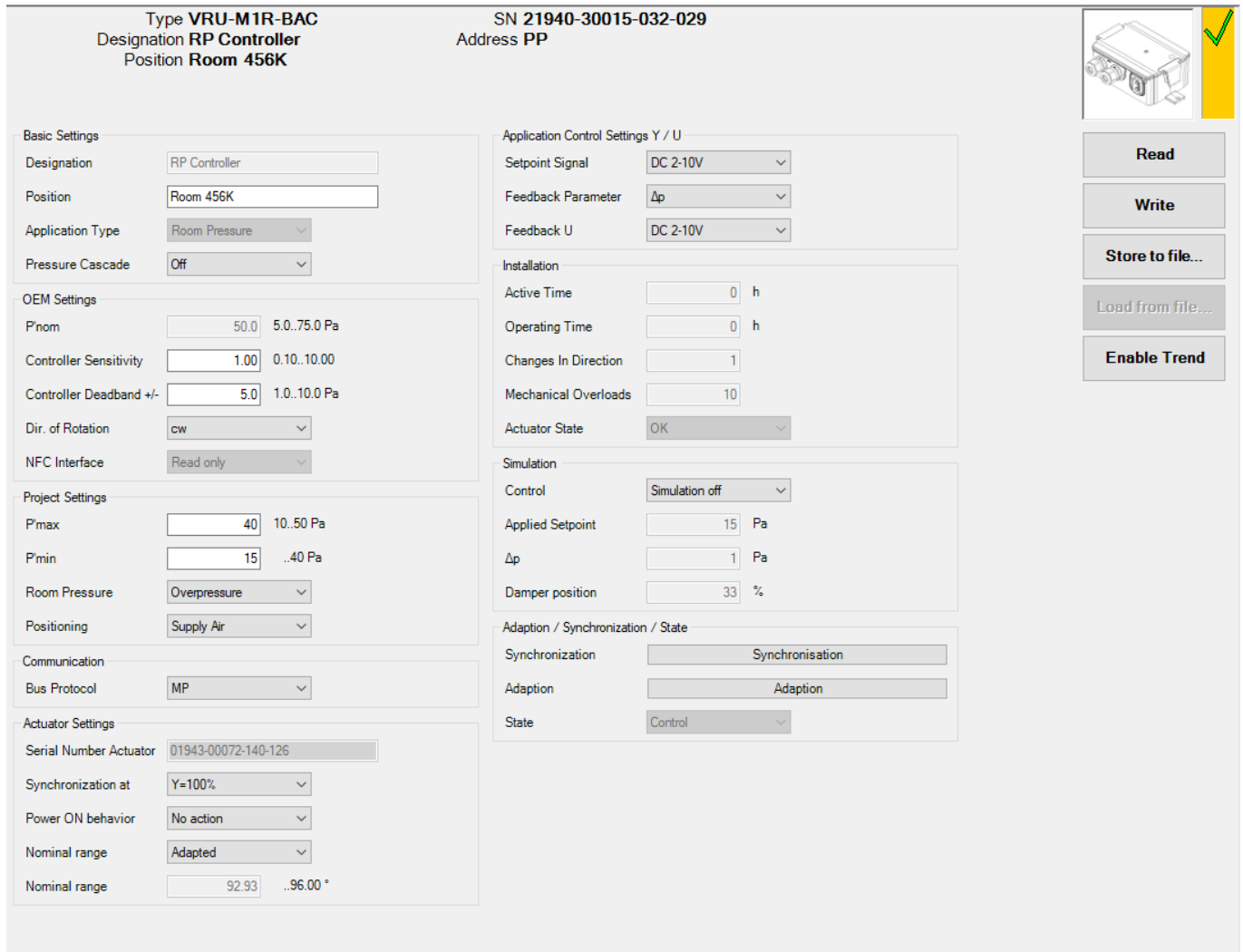

**Type VRU-M1R-BAC**  
**Designation RP Controller**  
**Position Room 456K**

**SN 21940-30015-032-029**  
**Address PP**

**Basic Settings**  
 Designation: RP Controller  
 Position: Room 456K  
 Application Type: Room Pressure  
 Pressure Cascade: Off

**OEM Settings**  
 P<sub>nom</sub>: 50.0 5.0..75.0 Pa  
 Controller Sensitivity: 1.00 0.10..10.00  
 Controller Deadband +/-: 5.0 1.0..10.0 Pa  
 Dir. of Rotation: cw  
 NFC Interface: Read only

**Project Settings**  
 P<sub>max</sub>: 40 10..50 Pa  
 P<sub>min</sub>: 15 ..40 Pa  
 Room Pressure: Overpressure  
 Positioning: Supply Air

**Communication**  
 Bus Protocol: MP

**Actuator Settings**  
 Serial Number Actuator: 01943-00072-140-126  
 Synchronization at: Y=100%  
 Power ON behavior: No action  
 Nominal range: Adapted  
 Nominal range: 92.93 ..96.00 \*

**Application Control Settings Y / U**  
 Setpoint Signal: DC 2-10V  
 Feedback Parameter: Δp  
 Feedback U: DC 2-10V

**Installation**  
 Active Time: 0 h  
 Operating Time: 0 h  
 Changes In Direction: 1  
 Mechanical Overloads: 10  
 Actuator State: OK

**Simulation**  
 Control: Simulation off  
 Applied Setpoint: 15 Pa  
 Δp: 1 Pa  
 Damper position: 33 %

**Adaption / Synchronization / State**  
 Synchronization: Synchronisation  
 Adaption: Adaption  
 State: Control

**Buttons:** Read, Write, Store to file..., Load from file..., Enable Trend

Main view of a VRU-M1R-BAC device

The displayed settings will vary depending on the settings selected for the device in every available field. All settings are available for the *Room Pressure* application.

A description of the available settings can be found in the table below.

Settings Description

<b>Basic Settings</b>	
Designation	Description of the device. 16 characters of any text.
Position	Identification of the location / plant for the device. 16 characters of any text.
Application Type	Application active (only Room Pressure available)
Pressure Cascade	Room Pressure cascade application. Enables the VRU-M1R-BAC as primary $\Delta p$ circuit. (On / On, fast / Off)
<b>OEM Settings</b>	
Pnom	Nominal Pressure. Specific parameter set by the manufacturer.
Controller Sensitivity	Defines sensitivity of the controller (0.10-10.00)
Controller Deadband	Defines the dead band of the controller (1.0-10.0 %)
Dir. of Rotation	Clockwise/counterclockwise operation of attached actuator.
NFC Interface	NFC mode (read/write).
<b>Project Settings</b>	
Pmax	Upper limit of operating pressure.
Pmin	Lower limit of operating pressure.
Room Pressure	Sets up calculations for $\Delta p$ (Overpressure / Under pressure).
<b>Actuator Settings</b>	
Synchronization at	Stop position 0% or 100%
Power ON behavior	Behavior when system is switched on or after a voltage interruption. (No action / Adaption / Synchronization).
Nominal range (Menu)	Angle of rotation range. Defines the range limitation. (Adapted / Programmed).
Nominal range (number)	Adapted: To the range of rotation from the mechanical stop settings. Programmed: Selects the maximum angle of rotation.
<b>Application Control Settings Y / U</b>	
Setpoint	Defines the source of the setpoint received (Bus / Analog).
Setpoint Signal	Defines the setpoint signal type
0...10 V	Fixed operating range from 0 to 10 V
2...10 V	Fixed operating range from 2 to 10 V
Variable	Voltage range can be defined: Start 0.0...8.0 V / Stop 2.0...10.0 V Range between start and stop must be at least 2 V.
Feedback Parameter	Defines the feedback received (Position / $\Delta p$ )
Feedback U	Defines the feedback signal type
0...10 V	Fixed operating range from 0 to 10 V
2...10 V	Fixed operating range from 2 to 10 V
Variable	Voltage range can be defined: Start 0.0...8.0 V / Stop 2.0...10.0 V Range between start and stop must be at least 2 V.



<b>Installation</b>	
Active Time <sup>1</sup>	Motor active time in hours.
Operating Time	Powered time in hours.
Changes in Direction <sup>1</sup>	Direction change counter.
Mechanical Overload <sup>1</sup>	Mechanical Overload counter.
Actuator State <sup>1</sup>	Feedback Status from actuator (OK / Cannot Move / Gear disengaged / Travel increased / Actuator doesn't match)
<b>Simulation</b>	
Control	Select the desired behavior of the actuator for the simulation (Open / Close / Nominal / Min / Max / Motor Stop / Setpoint %)
Applied Setpoint	Actual defined setpoint (Pa)
Applied Setpoint	Defines the $\Delta p$ to be simulated
$\Delta p$	Actual $\Delta p$ value
Damper	Actual damper position
<b>Synchronization / Adaption / State</b>	
Synchronization	Moves to a mechanical limit (according to the setting "Synchronization at").
Adaption	Moves to both mechanical limits and recalculates angle-dependent parameters.
State	Shows status of the actuator. If no synchronization or adaption is in progress, the displayed value is "Control".
<b>Communication</b>	
Bus Protocol	Defines bus protocol used (MP / BACnet MS/TP / Modbus RTU)
MAC Address <sup>1</sup>	Defines the address of the actuator (BACnet: 1-127 / Modbus: 1-247)
Baudrate <sup>1</sup>	Defines the communication baud rate. (9600 / 19200 / 38400 / 76800 / 115200)
Terminating Resistor <sup>1</sup>	Terminating resistor is present in bus (On / Off)
Instance Number <sup>1</sup>	Defines BACnet instance number (1-4194304)
Device Name <sup>1</sup>	Defines BACnet device name. 32 characters of any text.
Max. Master <sup>1</sup>	Defines maximum BACnet Master (1-127)
Parity <sup>1</sup>	Defines Modbus parity (1-8-N-2 / 1-8-E-1 / 1-8-O-1 / 1-8-N-1)

<sup>1</sup> The visualization of the setting is influenced by the overall settings of the controller.

### 3.2 Room Pressure Application

**Room pressure control RP:**

Suitable for rooms with **non-critical** leakage rates / overflows.

- o Modulation: P'min ... P'max / Motor stop.
- o Step operation: P'min / P'max / Damper closed / Damper open / Motor stop.

**Volume flow & room pressure control:**

Suitable for rooms with low leakage rate / overflow.

- o Volume flow VAV / CAV: V'min ... V'max
- o Room pressure bypass damper: P'min / P'max / Motor Stop

**Room pressure & volume flow cascade control**

This application consists on:

- o Room pressure cascade controller (VRU-M1R-BAC [RPC])
- o Volume flow rate cascade controller (VRU-D3/M1-BAC [VAV]).
- o Volume flow controller (VRU-D3/M1-BAC [VAV]).

For a more detailed information about the application, please consult the document *Room and system applications with VAV-Universal*.

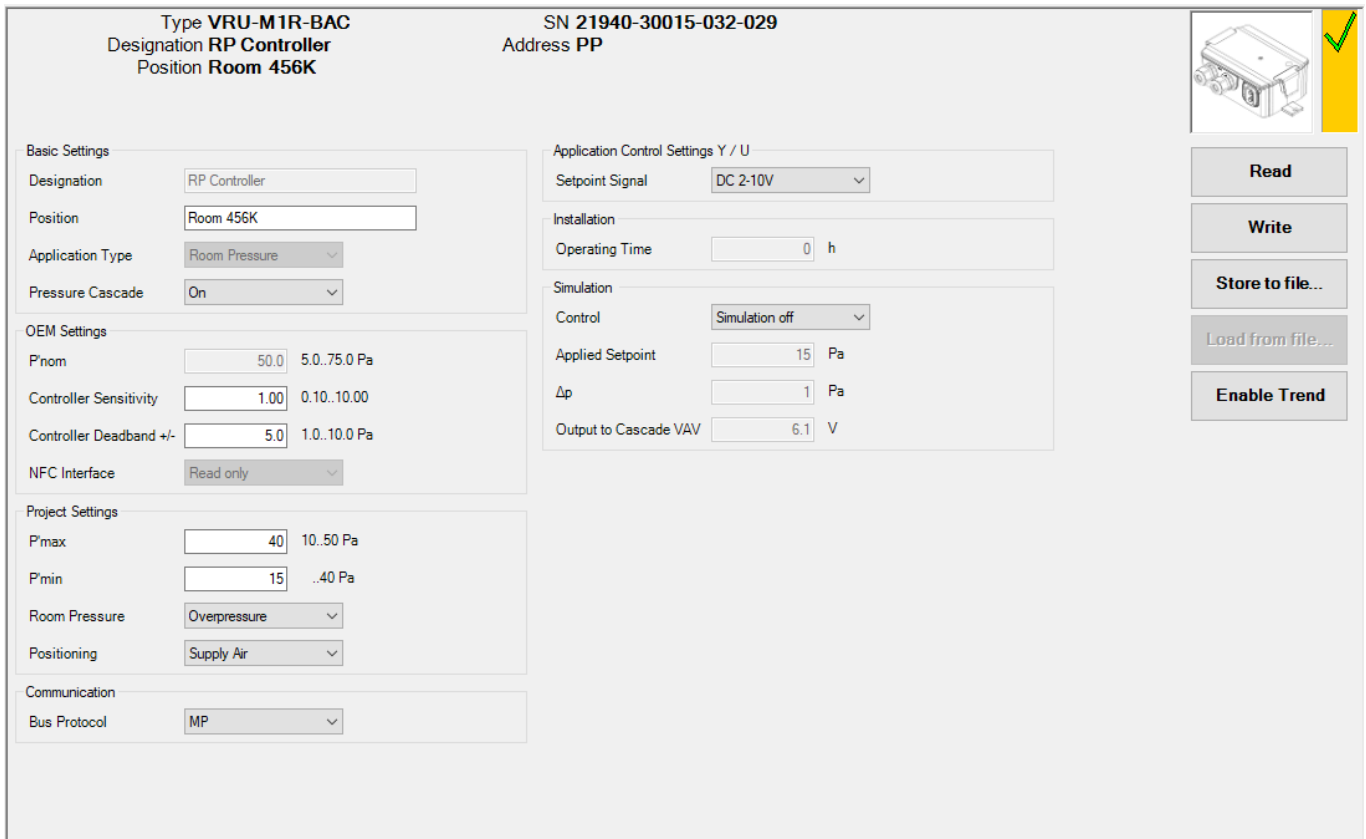

*View of a VRU-M1R-BAC device with Room pressure control application active*

### 3.3 Enable Trend functionality

At any moment, the time progress of the setpoint and actual values can be displayed in a plot. This graphic can be visualized through the button "Enable Trend". The values are saved in a trend file and can be displayed again at a later time. Furthermore, you can add any comment texts you would like.



On trend record, the trend is automatically saved to a temporary file and retained for one month. Click on the icon "Save" to save the trend with a different name and location (after stop record).

In the PC tool options "General" specify whether the program should ask for the new file name (ask user if trend files should be saved). The suggested file name can be modified before saving the file.

Click the "Trend Record" button. The display changes to a "flat" button with the label "Stop Record". The recording stops when you click the button again.



The position is queried every second by default. You can change the query interval in an input box. The permitted values are 0 to 9999 seconds, whereby the value 0 means "no waiting time" (query as quickly as possible).

If V'nom was set to 0 l/min, then the volumetric flows will be specified in % in the trend display instead of in volumetric units.

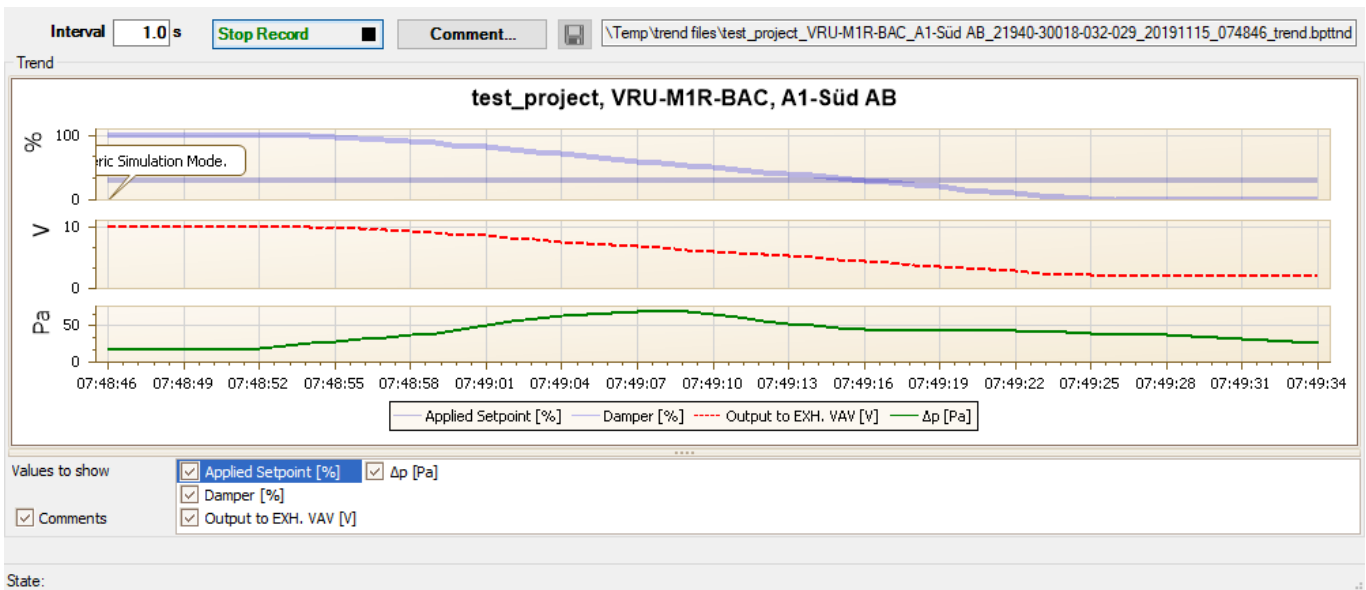

*Trending area available in PC-Tool*

The Comment button allows you to enter a text at a defined time and the text is then saved in the trend file.

Override events are automatically logged with timestamp as comment.

If you want to record a trend for more than one hour (long-term trend), enter a value of at least 2 seconds for the interval. If the interval is shorter, too many data points will result and the time for correcting the curve between the queries can become too short.

# **PC-Tool V3.16 PR(K)**

## **User Manual**

### **English**

# Table of Contents

1	Introduction.....	3
2	PR(K) .....	4
2.1	Displayed settings .....	4
2.2	Enable Trend functionality .....	7



## 1 Introduction

The "PR(K)" module user manual describes the detail area [D] of the PR(K) butterfly valve actuators.

## 2 PR(K)

### 2.1 Displayed settings

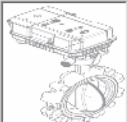
PC-Tool gives in a single tab an overview of the current settings of the PRCA-BAC-S2-T-200. Settings may differ from type to type.

Type PRKCA-BAC-S2-T-200		SN 01747-00113-163-049			
Designation Room1		Address PP			
Position Left corner					
<b>Basic Settings</b>					
Designation	<input type="text" value="Room1"/>	Operation			
Position	<input type="text" value="Left corner"/>	Full open	<input type="text" value="3"/>	<b>Read</b>	
Setpoint	<input type="text" value="Bus"/>	Full close	<input type="text" value="7"/>	<b>Write</b>	
Running Time	<input type="text" value="33"/> 30..120 s	Motor Starts	<input type="text" value="9"/>	<b>Store to file...</b>	
Max. Position	<input type="text" value="50"/> 33..100 %	Change In Direction	<input type="text" value="8"/>	<b>Load from file...</b>	
Valve Settings	<input type="text" value="DN200/8"/>	System		<b>Enable Trend</b>	
<b>Application Control Settings Y / U</b>					
Control	<input type="text" value="x...10 V"/>	Mechanical Overload		<input type="text" value="0"/>	
Y3 Start	<input type="text" value="2.0"/> 0.5..2.0 V	NFC enabled		<input type="text" value="1"/>	
Y3 Stop	<input type="text" value="10.0"/> 4.0..10.0 V	Simulation			
Control Signal	<input type="text" value="Normal"/>	Override Control		<input type="text" value="None"/>	
U5 Start	<input type="text" value="1.5"/> 0.5..2.0 V	Valve Position		<input type="text" value="0"/> %	
U5 Stop	<input type="text" value="9.5"/> 3.5..10.0 V				
Feedback Signal	<input type="text" value="Normal"/>				
<b>Bus Settings</b>					
Bus Protocol	<input type="text" value="BACnet MS/TP"/>				
MAC Address	<input type="text" value="1"/> ..127				
Baudrate	<input type="text" value="38400"/>				
Terminating Resistor	<input type="text" value="Off"/>				
Instance Number	<input type="text" value="1"/>				
Device Name	<input type="text"/>				
Max Master	<input type="text" value="127"/> ..127				
<b>Installation</b>					
Voltage Source	<input type="text" value="24V DC"/>				
Voltage Failures	<input type="text" value="5"/>				
Operating Time	<input type="text" value="576"/> h				
Active Time	<input type="text" value="0"/> h				

Main view of a PRCA-BAC-S2-T-200 device

<b>Basic Settings</b>	
Designation	Description of the device. 16 characters of any text.
Position	Identification of the location / plant of the device. 32 characters of any text.
Setpoint <sup>1</sup>	Defines the source of the setpoint received (Bus / Analog).
Running Time	Time needed to cover the full operating range (30...120s).
Sensor 1 / 2	If a sensor is configured (via Modbus or BACnet) – Sensor type e.g. PT1000 and temperature will be displayed.
Max. Position	Limitation of the angle of rotation. Range 33...100%
Valve Settings	Specifying the actual parameterization of the actuator for the specific DN sizes of the valve. Selection: Regular, DN200/8 or DN250/10
<b>Application Control Settings Y / U</b>	
Control	Different options for control type. Positions: x...10V / O-C /3-point / 4...20mA
Y3 Start	Starting point for control. Range between 0.5 ...2.0 V
Y3 Stop	End point for control. Range between 4.0 ...10.0 V
Control signal	Type of control signal. Normal or inverted.
U5 Start	Starting point for feedback signal. Range between 0.5...2.0 V
U5 Stop	End point for feedback signal. Range between 4.0...10.0 V
Feedback Signal	Type of feedback signal. Normal or inverted.
<b>Bus Settings</b>	
Bus Protocol	Defines bus protocol used (MP / BACnet MS/TP / Modbus RTU)
MP Address <sup>1</sup>	MP Address of the actuator
MAC Address <sup>1</sup>	Defines the address of the actuator (BACnet: 1-127 / Modbus: 1-247)
Baudrate <sup>1</sup>	Defines the communication baud rate. (9600 / 19200 / 38400 / 76800 / 115200)
Terminating Resistor <sup>1</sup>	Terminating resistor is present in bus (On / Off)
Instance Number <sup>1</sup>	Defines BACnet instance number (1-4194304)
Device Name <sup>1</sup>	Defines BACnet device name. 32 characters of any text.
Max. Master <sup>1</sup>	Defines maximum BACnet Master (1-127)
Parity <sup>1</sup>	Defines Modbus parity (1-8-N-2 / 1-8-E-1 / 1-8-O-1 / 1-8-N-1)
<b>Installation</b>	
Voltage Source	Shows the current voltage source. 24V AC or 230 V
Voltage Failures	Shows the total number of voltage failures/ power losses
Operating Time	Number of hours during which the actuator was connected to the power supply
Active Time	Number of hours during which the actuator was mechanically in motion and connected to the power supply
<b>Operation</b>	
Full Open	Shows the total number of full openings of the valves (reaching the upper end stop)
Full Close	Shows the total number of full closings of the valves (reaching the lower end stop)



Motor Starts	Total quantity of motor starts. How often the actuator starts running.
Change in Direction	Shows how often the actuator change its direction. High value could be an indication for a hunting system.
<b>System</b>	
Mechanical overload	Actuator did not reach setpoint because an obstacle has reduced the operating range.
NFC is enabled	Shows if NFC (Near Field Communication) is enabled or not. Value 1 = NFC is enabled. Value 0 = NFC is disabled.
<b>Simulation</b>	
Override Control	Remote control of the actuator via PC-Tool
Valve Position	Shows the actual valve position to which the actuator is mounted to. Value shown in %.

<sup>1</sup> The visualization of the setting is influenced by the overall settings of the controller.

Note: For the Supercap actuator the following fields are not displayed and can not be configured via the PC-Tool:

- Fail-safe position (POP). Factory setting: 0% (range 0 – 100%)
- Bridging time. Factory setting: 2 sec. (range 0 – 10 sec.)

## 2.2 Enable Trend functionality

At any moment, the time progress of the setpoint and actual values can be displayed in a plot. This graphic can be visualized through the button "Enable Trend". The values are saved in a trend file and can be displayed again at a later time. Furthermore, you can add any comment texts you would like.



On trend record, the trend is automatically saved to a temporary file and retained for one month. Click on the icon "Save" to save the trend with a different name and location (after stop record).

In the PC tool options "General" specify whether the program should ask for the new file name (ask user if trend files should be saved). The suggested file name can be modified before saving the file.

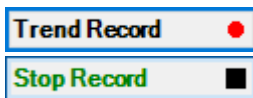

Click the "Trend Record" button. The display changes to a "flat" button with the label "Stop Record". The recording stops when you click the button again.

The position is queried every second by default. You can change the query interval in an input box. The permitted values are 0 to 9999 seconds, whereby the value 0 means "no waiting time" (query as quickly as possible).

Normally the actual setpoint is active. Can however be overwritten by Override control values.

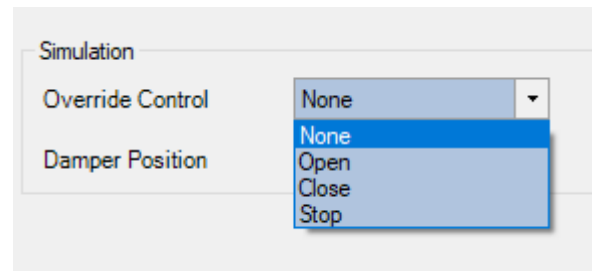

The Comment button allows you to enter a text at a defined time and the text is then saved in the trend file.

Override events are automatically logged with timestamp as comment.

---

If you want to record a trend for more than one hour (long-term trend), enter a value of at least 2 seconds for the interval. If the interval is shorter, too many data points will result and the time for correcting the curve between the queries can become too short.

---

**PC-Tool V3.16 – PM/PK module**  
**User Manual**  
**English**

# Table of Contents

1	Introduction.....	3
2	PM/PK.....	4
2.1	Displayed settings .....	4
2.2	Enable Trend functionality .....	7

# 1 Introduction

The "PM/PK module" user manual describes the detail area [D] of the damper actuators.



## 2 PM/PK

### 2.1 Displayed settings

PC-Tool gives in a single tab an overview of the current settings of the PMCA-BAC-S2-T. Setting may differ from type to type.

Type **PMCA-BAC-S2-T**  
 Designation **hak test**  
 Position **Ecke rechts**

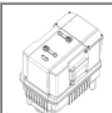
SN **01904-40012-163-049**  
 Address **PP**

**Basic Settings**

Designation

Position

Setpoint

Running Time  30..120 s

Sensor 1: PT1000  Ω

Max. Position  33..100 %

Mid. Position  .50 %

Min. Position  .20 %

**Application Control Settings Y / U**

Control

Y3 Start  0.5..2.0 V

Y3 Stop  2.5..10.0 V

Control Signal

U5 Start  0.5..2.0 V

U5 Stop  4.0..10.0 V

Feedback Signal

**Bus Settings**

Bus Protocol

MAC Address  ..127

Baudrate

Terminating Resistor

Instance Number

Device Name

Max Master  ..127

**Installation**

Voltage Source

Voltage Failures

Operating Time  h

Active Time  h

**Operation**

Full open

Full close

Motor Starts

Change In Direction

**System**

Mechanical Overload

NFC Enabled

**Simulation**

Override Control

Damper Position  %

**Read**

**Write**

**Store to file...**

**Load from file...**

**Enable Trend**

Main view of a PMCA-BAC-S2-T device

<b>Basic Settings</b>	
Designation	Description of the device. 16 characters of any text.
Position	Identification of the location / plant of the device. 32 characters of any text.
Setpoint <sup>1</sup>	Defines the source of the setpoint received (Bus / Analog).
Running Time	Time needed to cover the full operating range (30...120s).
Sensor 1 / 2	If a sensor is configured (via Modbus or BACnet) – Sensor type e.g. PT1000 and resistance will be displayed.
Max. Position	Limitation of the angle of rotation. Range 33...100%
Mid. Position	Min... Max %
Min. Position	0...70%, Min<=Max-30%
<b>Application Control Settings Y / U</b>	
Control	Different options for control type. Positions: x...10V / O-C /3-point / 4...20mA
Y3 Start	Starting point for control. Range between 0.5 ...2.0 V
Y3 Stop	End point for control. Range between 4.0 ...10.0 V
Control signal	Type of control signal. Normal or inverted.
U5 Start	Starting point for feedback signal. Range between 0.5...2.0 V
U5 Stop	End point for feedback signal. Range between 4.0...10.0 V
Feedback Signal	Type of feedback signal. Normal or inverted.
<b>Bus Settings</b>	
Bus Protocol	Defines bus protocol used (MP / BACnet MS/TP / Modbus RTU)
MP Address <sup>1</sup>	MP Address of the actuator
MAC Address <sup>1</sup>	Defines the address of the actuator (BACnet: 1-127 / Modbus: 1-247)
Baudrate <sup>1</sup>	Defines the communication baud rate. (9600 / 19200 / 38400 / 76800 / 115200)
Terminating Resistor <sup>1</sup>	Terminating resistor is present in bus (On / Off)
Instance Number <sup>1</sup>	Defines BACnet instance number (1-4194304)
Device Name <sup>1</sup>	Defines BACnet device name. 32 characters of any text.
Max. Master <sup>1</sup>	Defines maximum BACnet Master (1-127)
Parity <sup>1</sup>	Defines Modbus parity (1-8-N-2 / 1-8-E-1 / 1-8-O-1 / 1-8-N-1)
<b>Installation</b>	
Voltage Source	Shows the current voltage source. 24V AC or 230 V
Voltage Failures	Shows the total number of voltage failures/ power losses
Operating Time	Number of hours during which the actuator was connected to the power supply
Active Time	Number of hours during which the actuator was mechanically in motion and connected to the power supply
<b>Operation</b>	
Full Open	Shows the total number of full openings of the valves (reaching the upper end stop)

Full Close	Shows the total number of full closings of the valves (reaching the lower end stop)
Motor Starts	Total quantity of motor starts. How often the actuator starts running.
Change in Direction	Shows how often the actuator change its direction. High value could be an indication for a hunting system.
<b>System</b>	
Mechanical overload	Actuator did not reach setpoint because an obstacle has reduced the operating range.
NFC is enabled	Shows if NFC (Near Field Communication) is enabled or not. Value 1= NFC is enabled. Value 0 = NFC is disabled.
<b>Simulation</b>	
Override Control	Remote control of the actuator via PC-Tool
Valve Position	Shows the actual valve position to which the actuator is mounted to. Value shown in %.

<sup>1</sup> The visualization of the setting is influenced by the overall settings of the controller.

Note: For the Supercap actuator the following fields are not displayed and can not be configured via the PC-Tool:

- Fail-safe position (POP). Factory setting: 0% (range 0 – 100%)
- Bridging time. Factory setting: 2 sec. (range 0 – 10 sec.)



## 2.2 Enable Trend functionality

At any moment, the time progress of the setpoint and actual values can be displayed in a plot. This graphic can be visualized through the button "Enable Trend". The values are saved in a trend file and can be displayed again at a later time. Furthermore, you can add any comment texts you would like.



On trend record, the trend is automatically saved to a temporary file and retained for one month. Click on the icon "Save" to save the trend with a different name and location (after stop record).

In the PC tool options "General" specify whether the program should ask for the new file name (ask user if trend files should be saved). The suggested file name can be modified before saving the file.



Click the "Trend Record" button. The display changes to a "flat" button with the label "Stop Record". The recording stops when you click the button again.

The position is queried every second by default. You can change the query interval in an input box. The permitted values are 0 to 9999 seconds, whereby the value 0 means "no waiting time" (query as quickly as possible).

Normally the actual setpoint is active. Can however be overwritten by Override values.

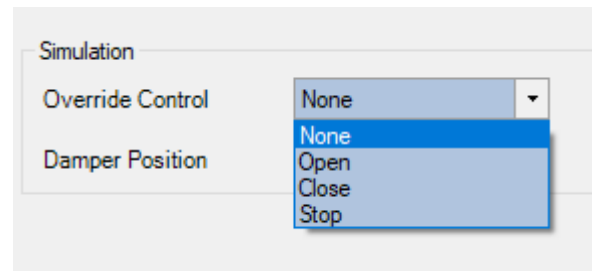

The Comment button allows you to enter a text at a defined time and the text is then saved in the trend file.

Override events are automatically logged with timestamp as comment.

---

If you want to record a trend for more than one hour (long-term trend), enter a value of at least 2 seconds for the interval. If the interval is shorter, too many data points will result and the time for correcting the curve between the queries can become too short.

---