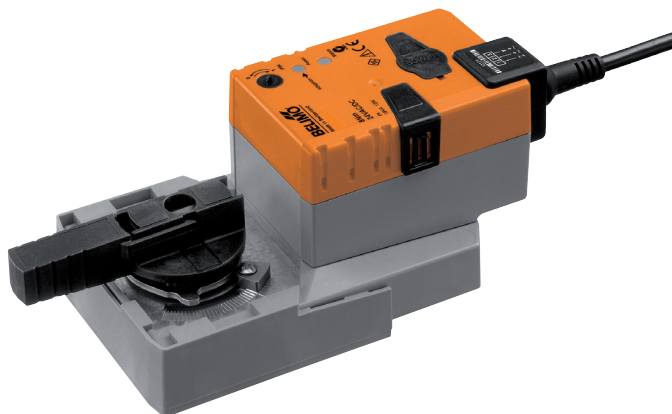

Modulating rotary actuator for ball valves

- Nominal torque 8 Nm
- Nominal voltage AC/DC 24 V
- Control Modulating DC (0)2...10 V
- Position feedback DC 2...10 V
- Running time motor 9 s

Technical data

Electrical data	Nominal voltage	AC/DC 24 V
	Nominal voltage frequency	50/60 Hz
	Nominal voltage range	AC 19.2...28.8 V / DC 19.2...28.8 V
	Power consumption in operation	13 W
	Power consumption in rest position	2 W
	Power consumption for wire sizing	23 VA
	Power consumption for wire sizing note	I _{max} 20 A @ 5 ms
	Connection supply / control	Cable 1 m, 4 x 0.75 mm ²
	Parallel operation	Yes (note the performance data)
Functional data	Torque motor	Min. 8 Nm
	Positioning signal Y	DC 0...10 V
	Positioning signal Y note	Input impedance 100 kΩ
	Operating range Y	DC 2...10 V
	Position feedback U	DC 2...10 V
	Position feedback U note	Max. 0.5 mA
	Position accuracy	±5%
	Manual override	Gear disengagement with push-button, can be locked
	Running time motor	9 s / 90°
	Adaption setting range	manual (automatic on first power-up)
	Sound power level motor max.	52 dB(A)
Position indication	Mechanically, pluggable	
Safety	Protection class IEC/EN	III Safety extra-low voltage
	Protection class UL	UL Class 2 Supply
	Degree of protection IEC/EN	IP54
	Degree of protection NEMA/UL	NEMA 2, UL Enclosure Type 2
	EMC	CE according to 2014/30/EU
	Certification IEC/EN	IEC/EN 60730-1 and IEC/EN 60730-2-14
	Mode of operation	Type 1
	Rated impulse voltage supply / control	0.8 kV
	Control pollution degree	3
	Ambient temperature	-30...40°C
	Ambient temperature note	Caution: +40...+50°C utilisation possible only under certain restrictions. Please contact your Belimo representative.
	Non-operating temperature	-40...80°C
	Ambient humidity	95% r.h., non-condensing
Maintenance	Maintenance-free	
Weight	Weight approx.	1.1 kg

Safety notes

- This device has been designed for use in stationary heating, ventilation and air conditioning systems and is not allowed to be used outside the specified field of application, especially in aircraft or in any other airborne means of transport.

*UL marked actuator is optional, please contact your local Sales Representative for details.

Safety notes

- Only authorised specialists may carry out installation. All applicable legal or institutional installation regulations must be complied during installation.
- The switch for changing the direction of rotation may only be operated by authorised specialists. The direction of rotation must not in particular be reversed in a frost protection circuit.
- The device may only be opened at the manufacturer's site. It does not contain any parts that can be replaced or repaired by the user.
- The cables must not be removed from the device.
- Self adaption is necessary when the system is commissioned and after each adjustment of the angle of rotation (press the adaption push-button once).
- The device contains electrical and electronic components and is not allowed to be disposed of as household refuse. All locally valid regulations and requirements must be observed.

Product features

Mode of operation	The actuator is connected with a standard modulating signal of DC 0...10V and travels to the position defined by the positioning signal. Measuring voltage U serves for the electrical display of the valve position 0...100% and as slave control signal for other actuators.
Direct mounting	Straightforward direct mounting on the ball valve with only one central screw. The assembly tool is integrated in the plug-in position indication. The mounting orientation in relation to the ball valve can be selected in 90° steps.
Manual override	Manual override with push-button possible (the gear is disengaged for as long as the button is pressed or remains locked).
High functional reliability	The actuator is overload protected, requires no limit switches and automatically stops when the end stop is reached.
Adjustable angle of rotation	Adjustable angle of rotation with mechanical end stops.
Home position	The first time the supply voltage is switched on, i.e. at the time of commissioning, the actuator carries out an adaption, which is when the operating range and position feedback adjust themselves to the mechanical setting range. The detection of the mechanical end stops enables a gentle approach to the end positions, thus protecting the actuator mechanics. The actuator then moves into the position defined by the positioning signal. Factory setting: Y2 (counter-clockwise rotation).
Adaption and synchronisation	An adaption can be triggered manually by pressing the „Adaption“ button. Both mechanical end stops are detected during the adaption (entire setting range). Automatic synchronisation after pressing the gearbox disengagement button is configured. The synchronisation is in the home position (0%).

Accessories

	Description	Type
Electrical accessories	Auxiliary switch, add-on, 1 x SPDT	S1A
	Auxiliary switch, add-on, 2 x SPDT	S2A
	Feedback potentiometer 140 Ohm, add-on	P140A
	Feedback potentiometer 200 Ohm, add-on	P200A
	Feedback potentiometer 500 Ohm, add-on	P500A
	Feedback potentiometer 1 kOhm, add-on	P1000A
	Feedback potentiometer 2.8 kOhm, add-on	P2800A
	Feedback potentiometer 5 kOhm, add-on	P5000A
	Feedback potentiometer 10 kOhm, add-on	P10000A

Electrical installation



Notes

- Connection via safety isolating transformer.
- Parallel connection of other actuators possible. Observe the performance data.
- Direction of rotation switch is covered. Factory setting: Direction of rotation Y2.

Electrical installation

Wiring diagrams

AC/DC 24 V, modulating

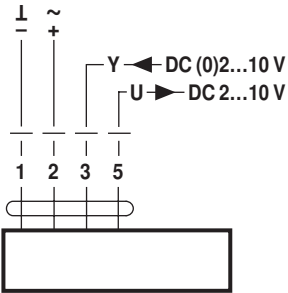

Cable colours:
 1 = black
 2 = red
 3 = white
 5 = orange

Override control (frost protection circuit)

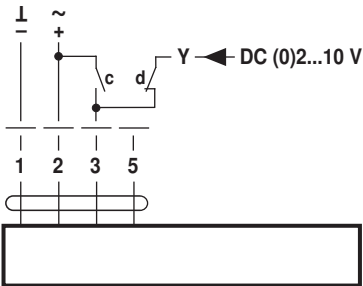

Cable colours:
 1 = black
 2 = red
 3 = white
 5 = orange

c	d	Y1 / Y2	
		Y1	A - AB = 100%
		Y2	A - AB = 0%
		DC (0)2...10 V	

Signal cable lengths

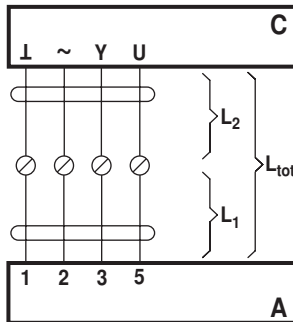

L ₂ I / ~	L _{tot} = L ₁ + L ₂	
	AC	DC
0.75 mm ²	≤30 m	≤5 m
1.00 mm ²	≤40 m	≤8 m
1.50 mm ²	≤70 m	≤12 m
2.50 mm ²	≤100 m	≤20 m

A = actuator
 C = control unit
 L1 = Belimo connecting cable, 1 m (4 x 0.75 mm²)
 L2 = customer cable
 Ltot = maximum signal cable length

Note:
 In the event of several actuators switched in parallel, the maximum signal cable length is to be divided by the number of actuators.

Operating controls and indicators

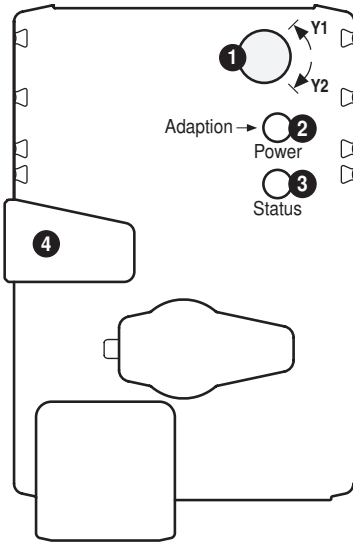

1 Direction of rotation switch

Switch over: Direction of rotation changes

2 Push-button and LED display green

Off: No power supply or malfunction

On: In operation

Press button: Triggers angle of rotation adaptation, followed by standard mode

3 Push-button and LED display yellow

Off: Standard mode

On: Adaptation or synchronising process active

Press button: No function

4 Gear disengagement button

Press button: Gear disengages, motor stops, manual override possible

Release button: Gear engages, synchronisation starts, followed by standard mode

Check power supply connection

2 Off and 3 On Possible wiring error in power supply

Dimensions [mm]

Dimensional drawings

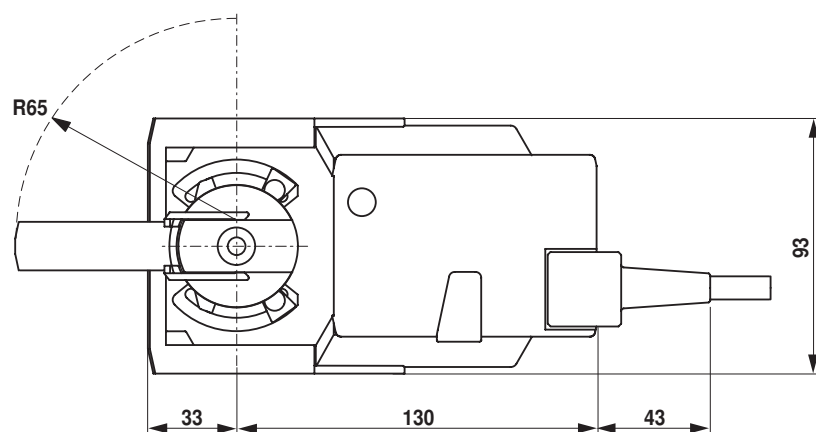
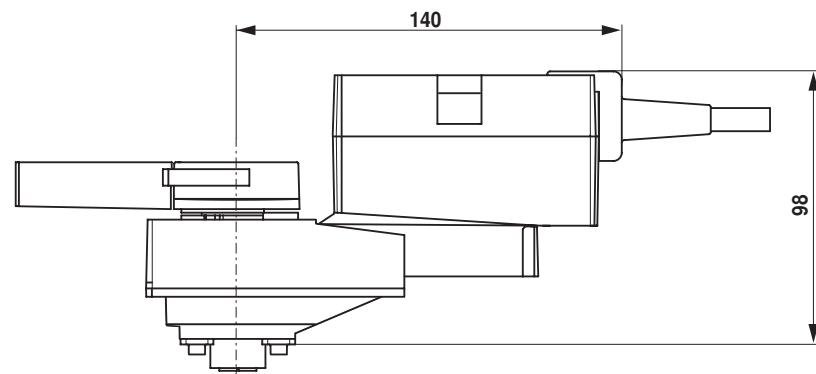

Further documentation

- Overview Valve-actuator combinations
- Data sheets for ball valves
- Installation instructions for actuators and/or ball valves
- General notes for project planning